

4 1/4" [108.00]

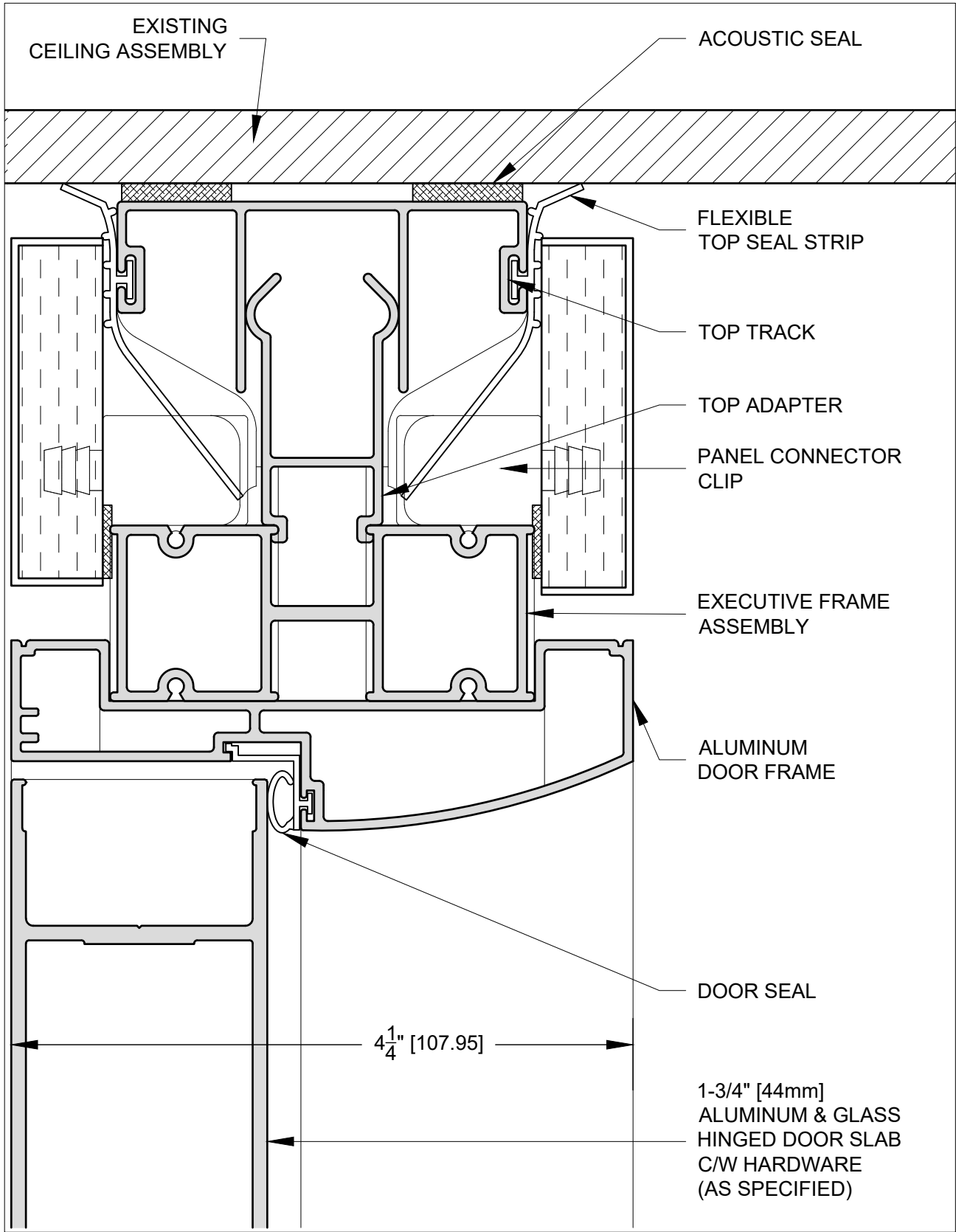

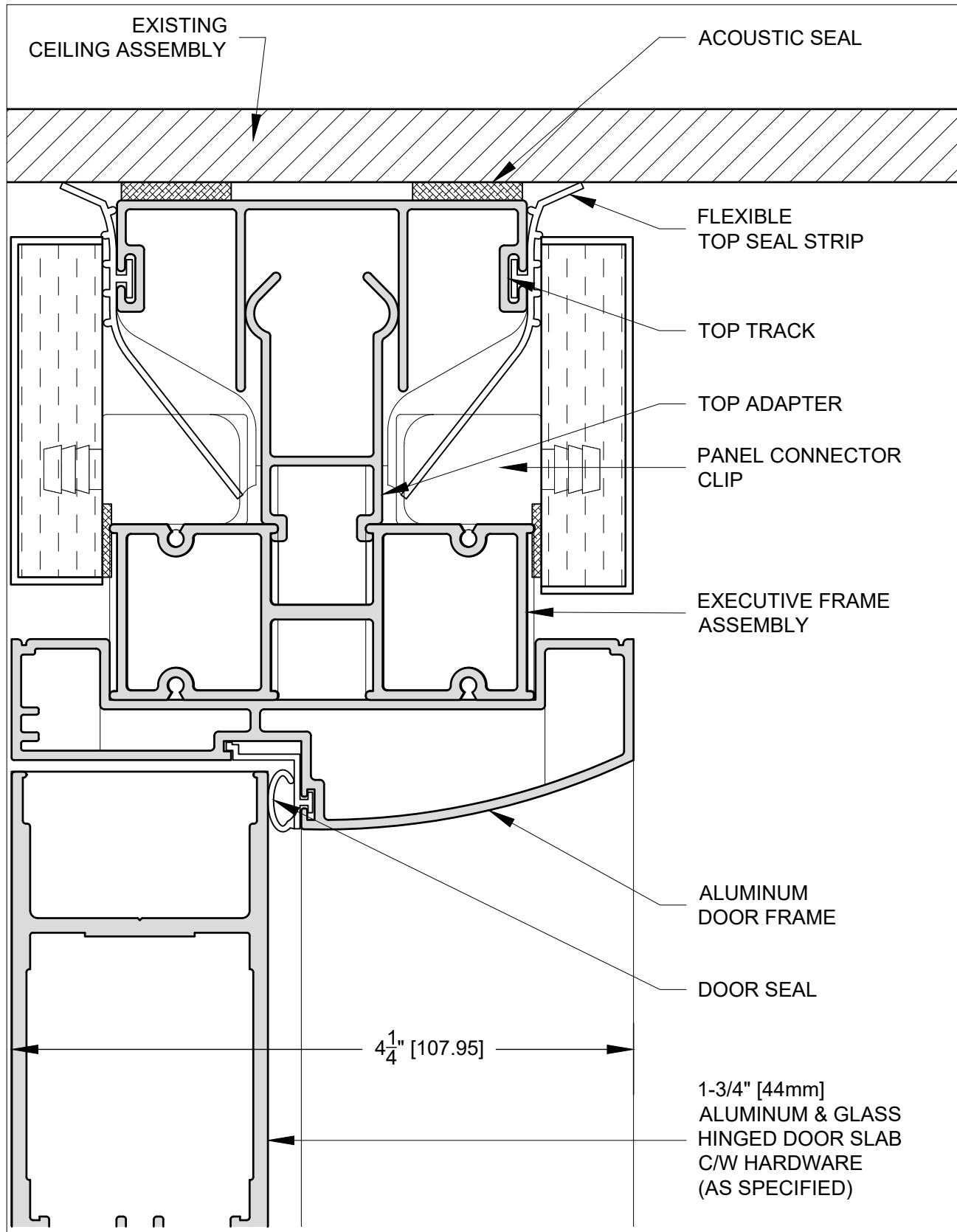



4 1/4" [107.95]

1-3/4" [44mm]  
ALUMINUM & GLASS  
HINGED DOOR SLAB  
C/W HARDWARE  
(AS SPECIFIED)



### V5 HINGE DOOR CEILING ASSEMBLY

DWG:  
**1.1.1.6**

FILE: SCALE: 1 : 1 DATE: OCT 2020

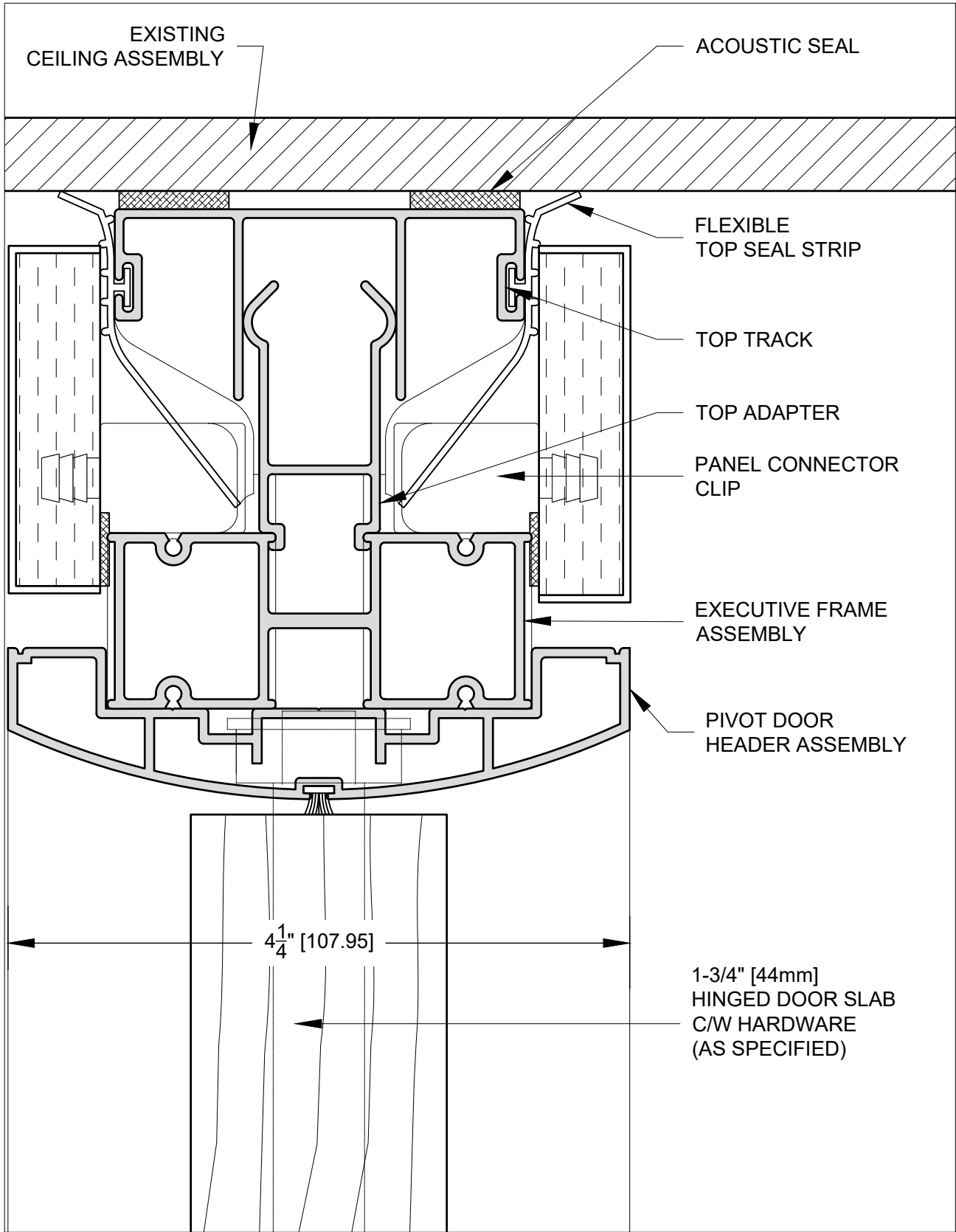

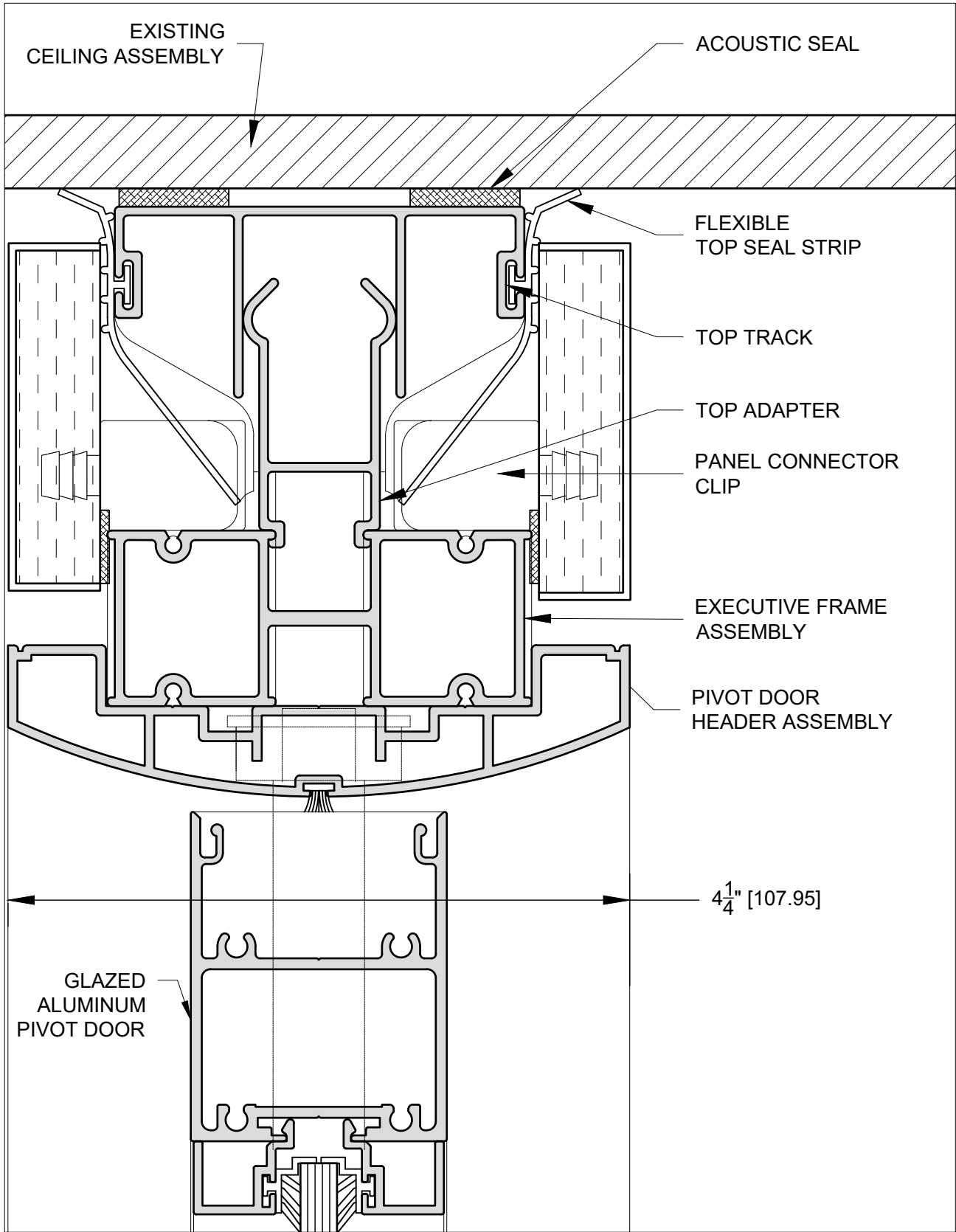

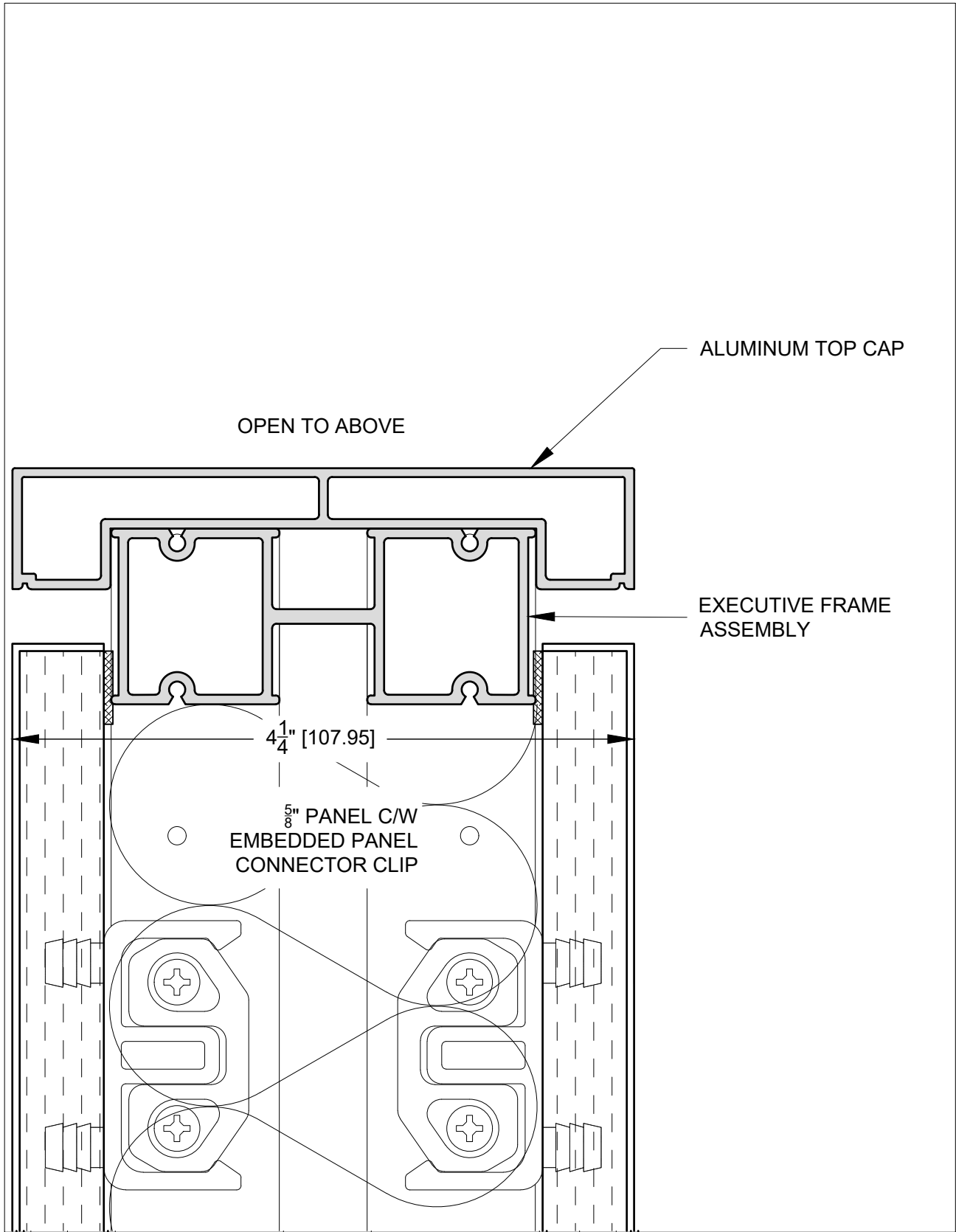

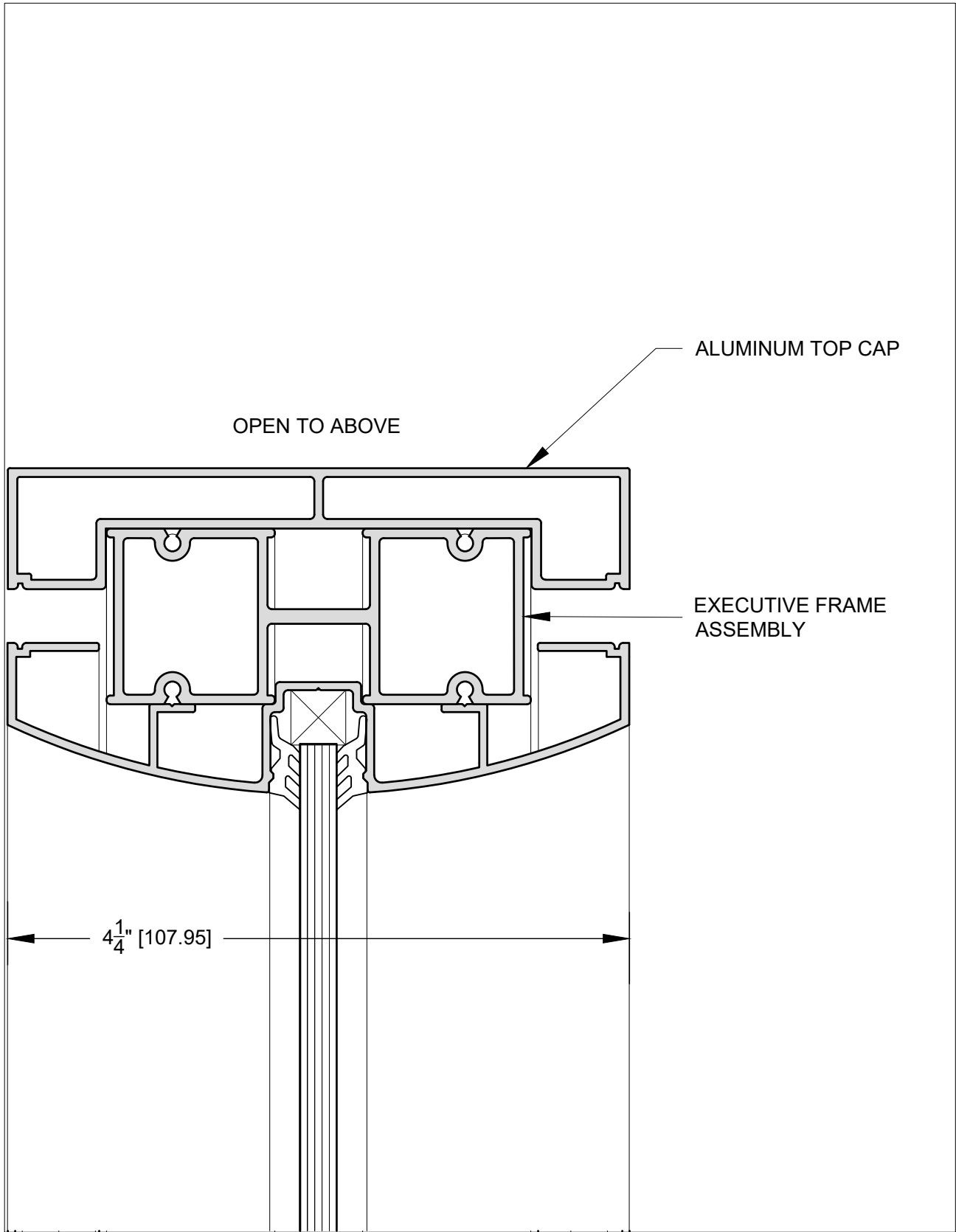

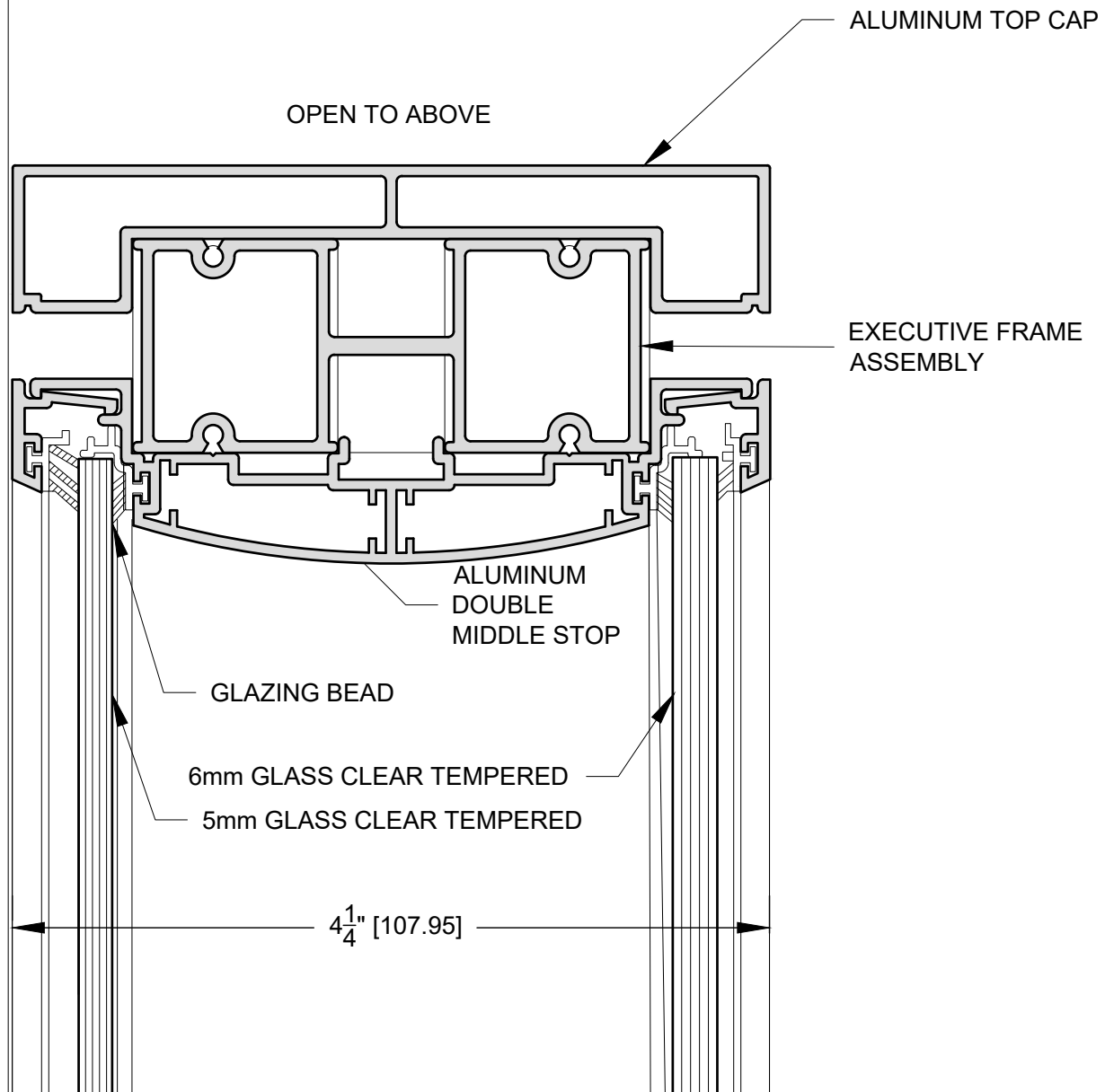

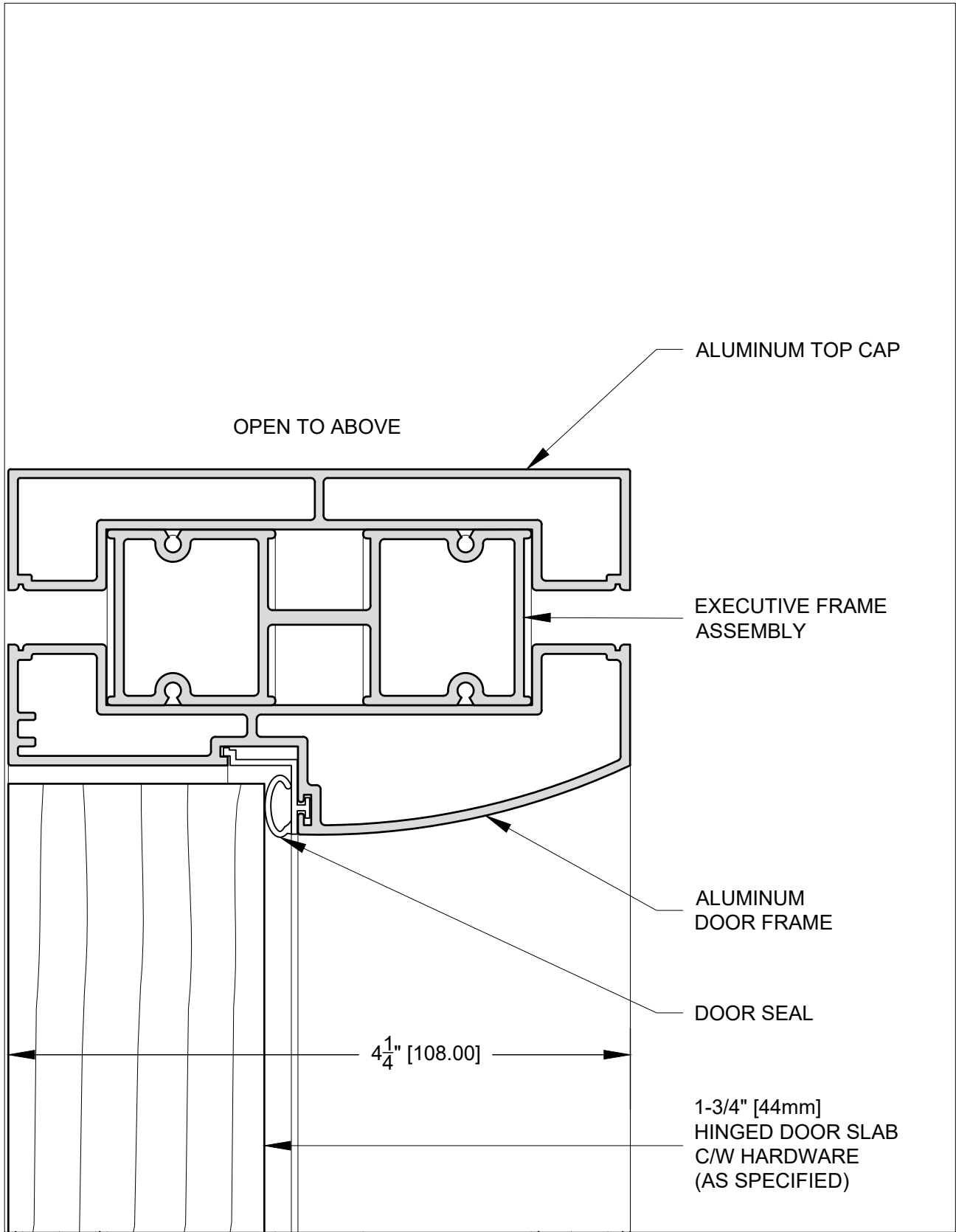



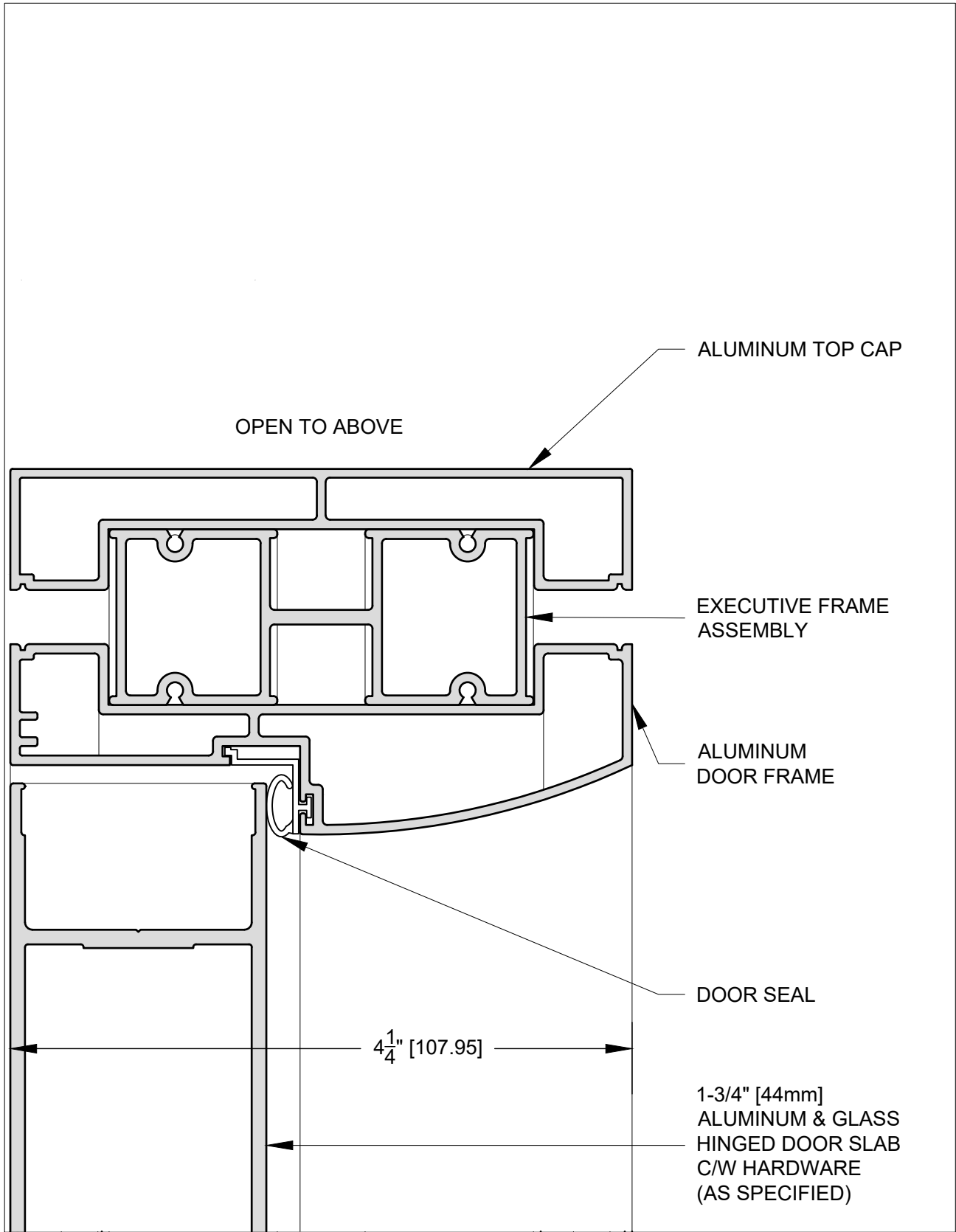

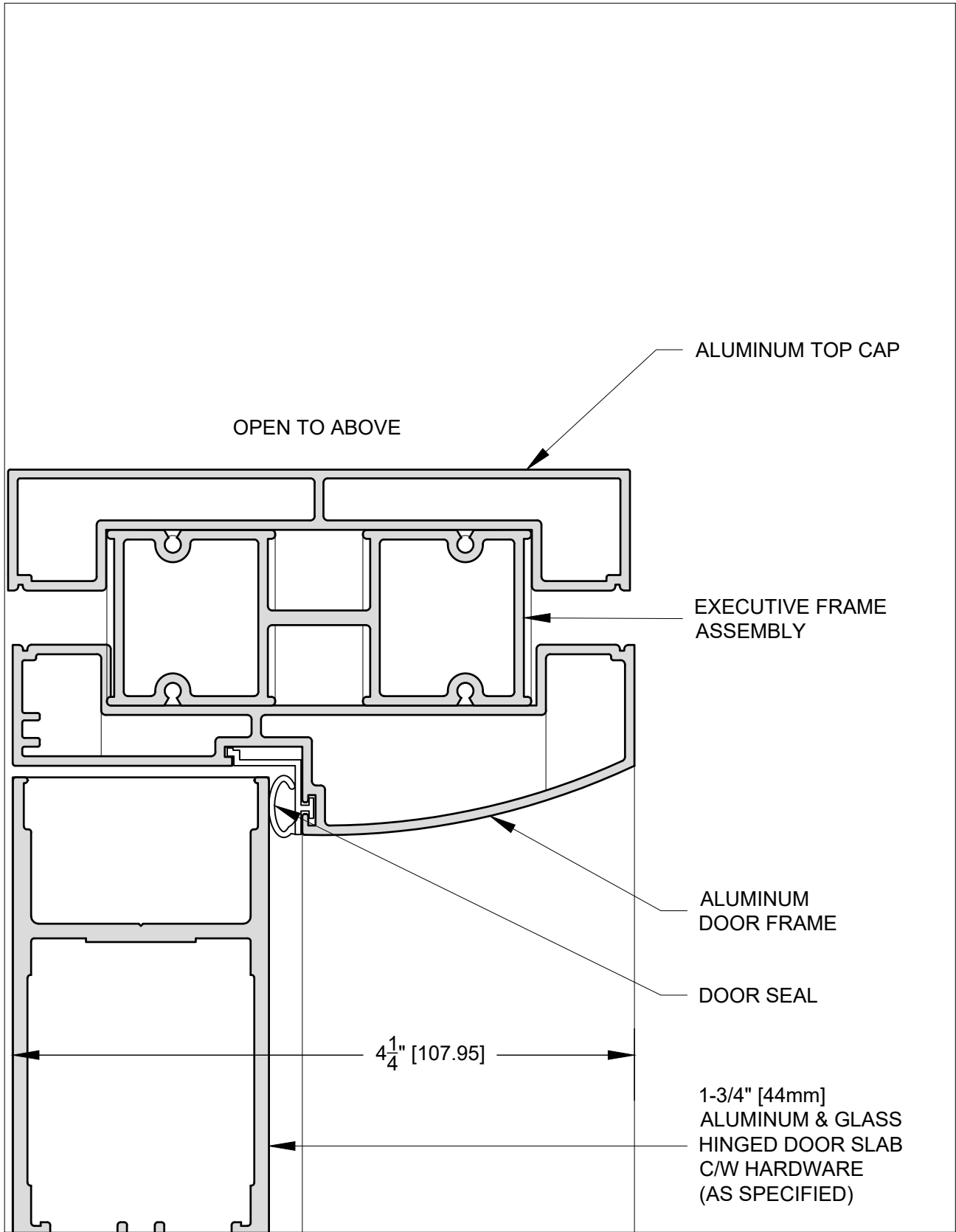

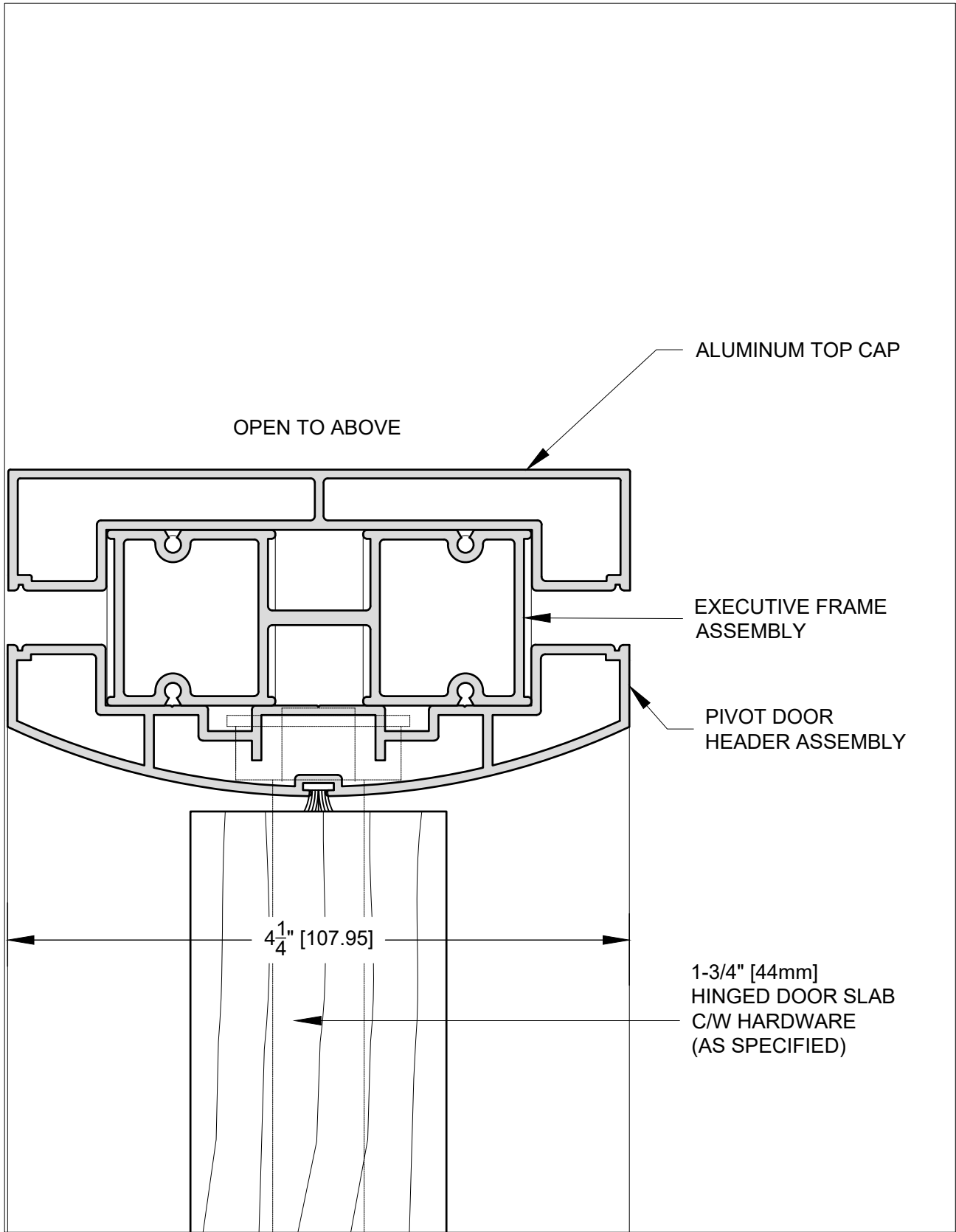

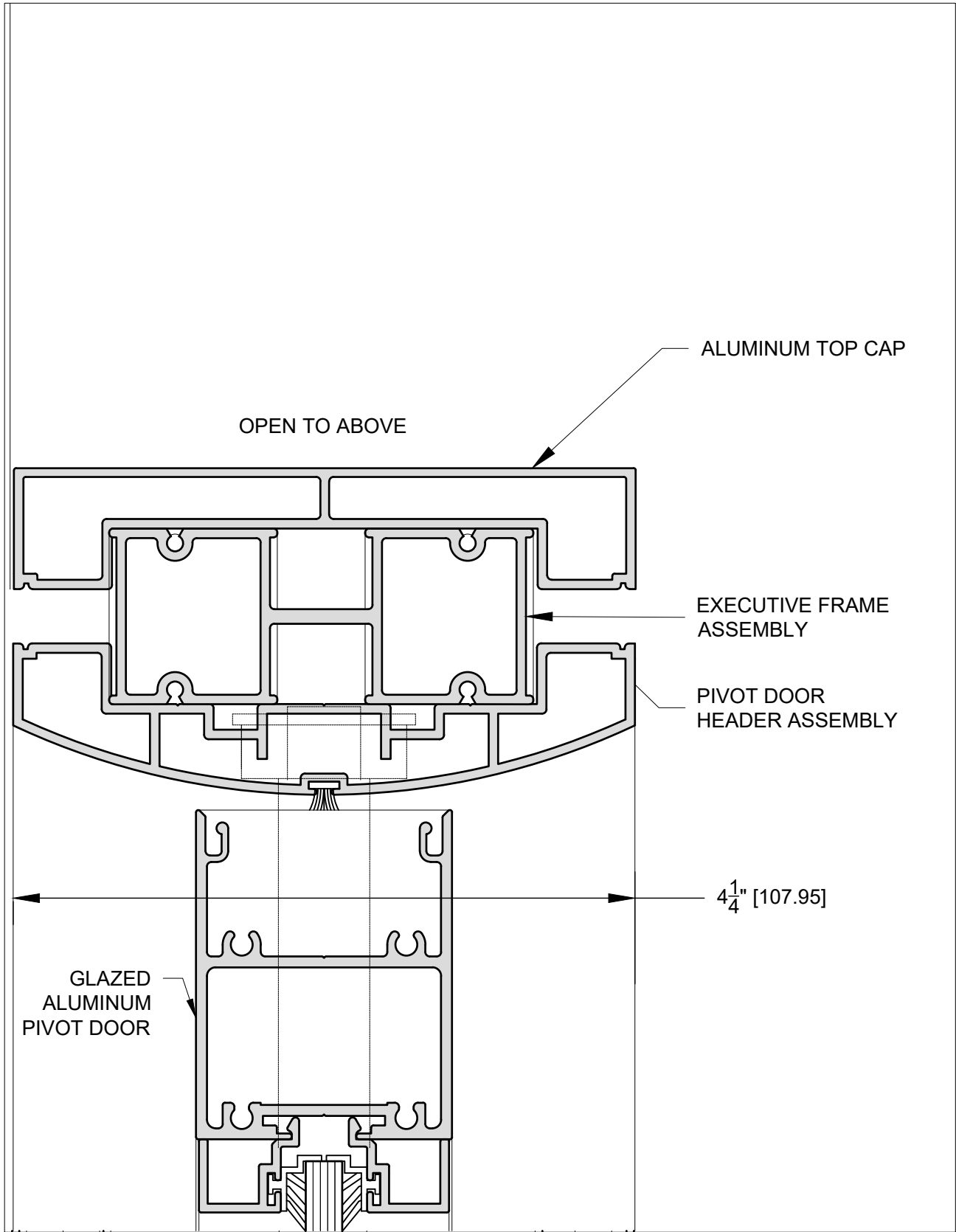

OPEN TO ABOVE

ALUMINUM TOP CAP

EXECUTIVE FRAME ASSEMBLY

PIVOT DOOR HEADER ASSEMBLY

4 1/4" [107.95]

GLAZED ALUMINUM PIVOT DOOR



ALUMINUM PIVOT DOOR WALL TOP

DWG:

1.1.2.8

FILE:

SCALE: 1 : 1

DATE: OCT 2020

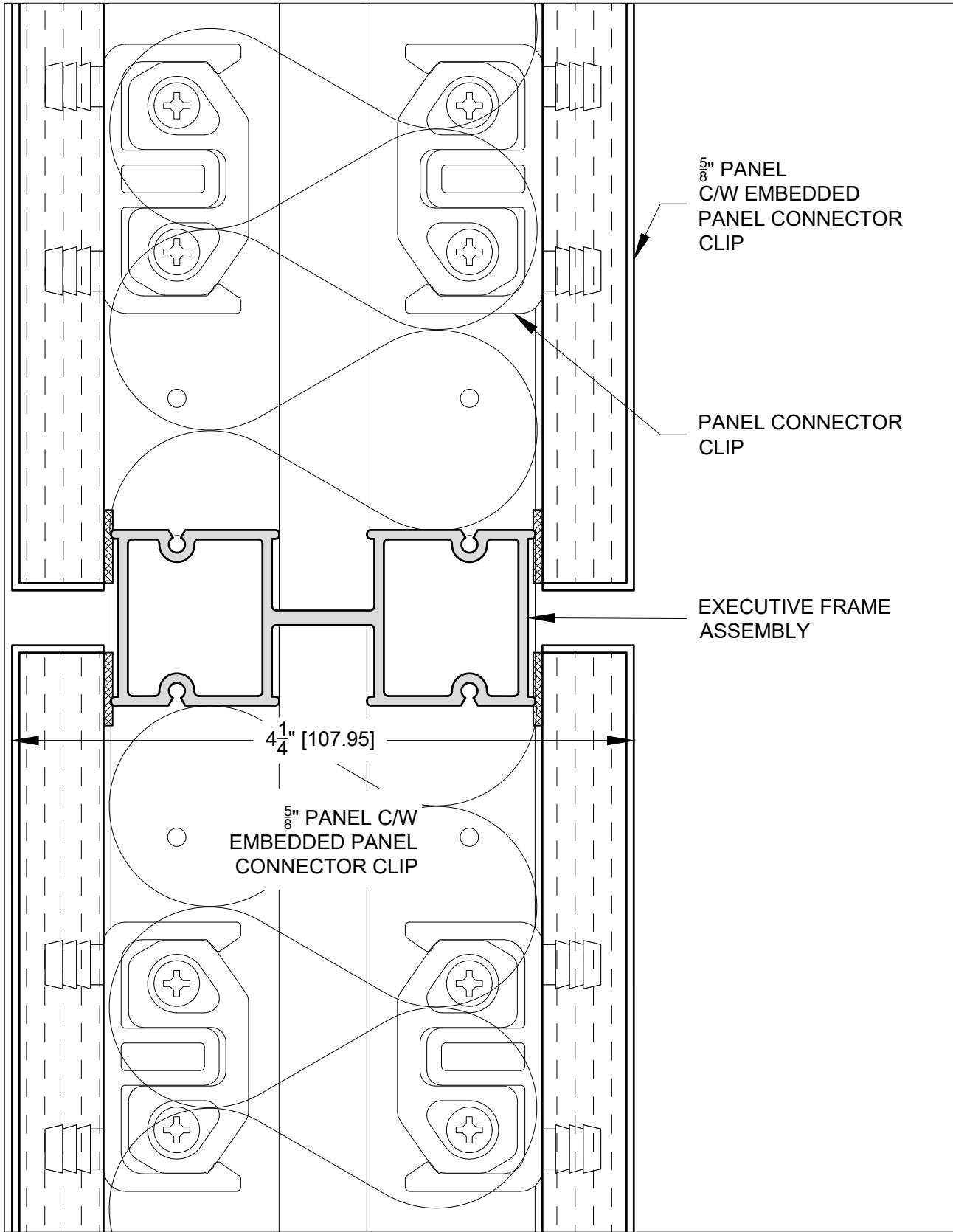

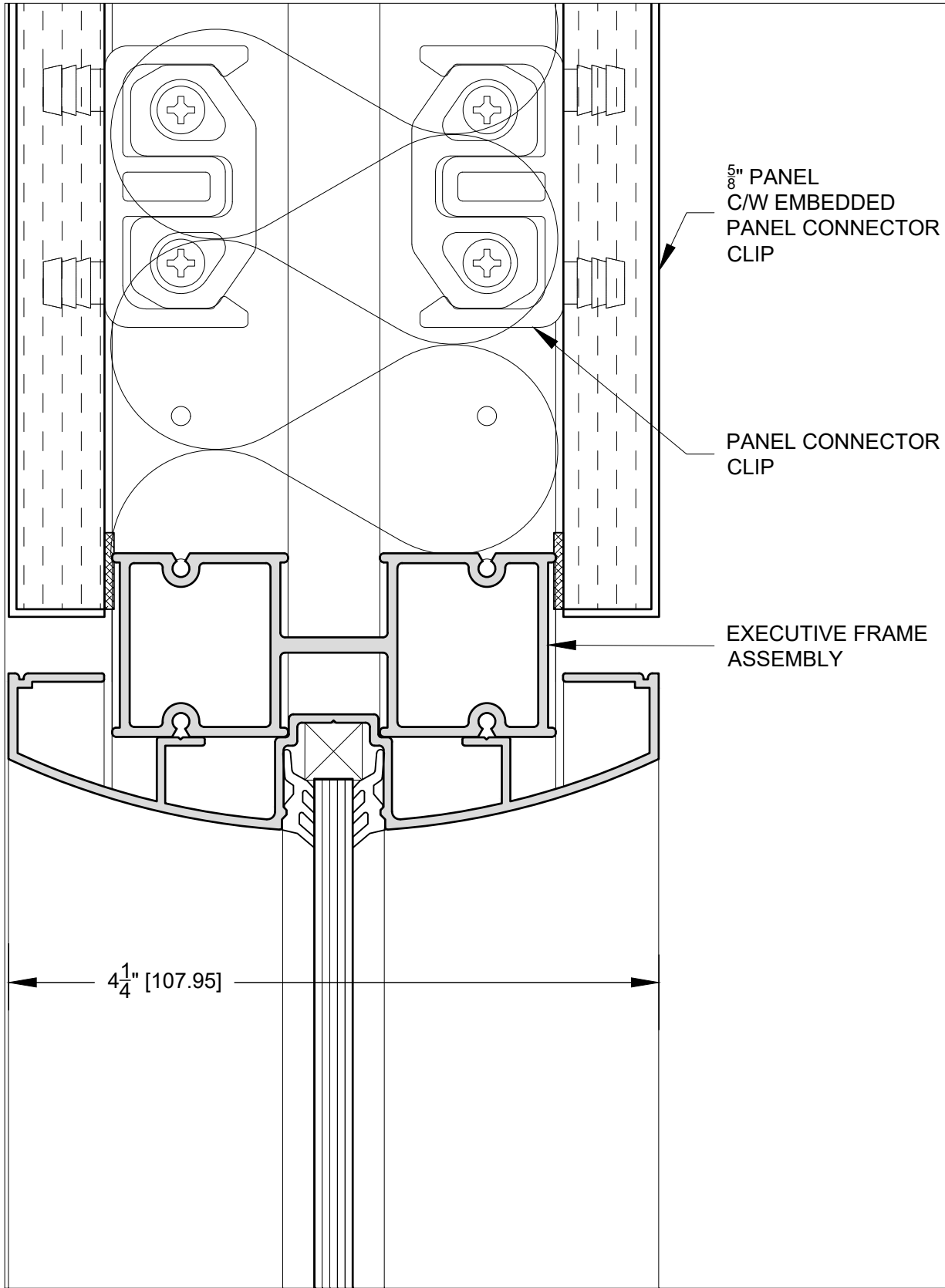

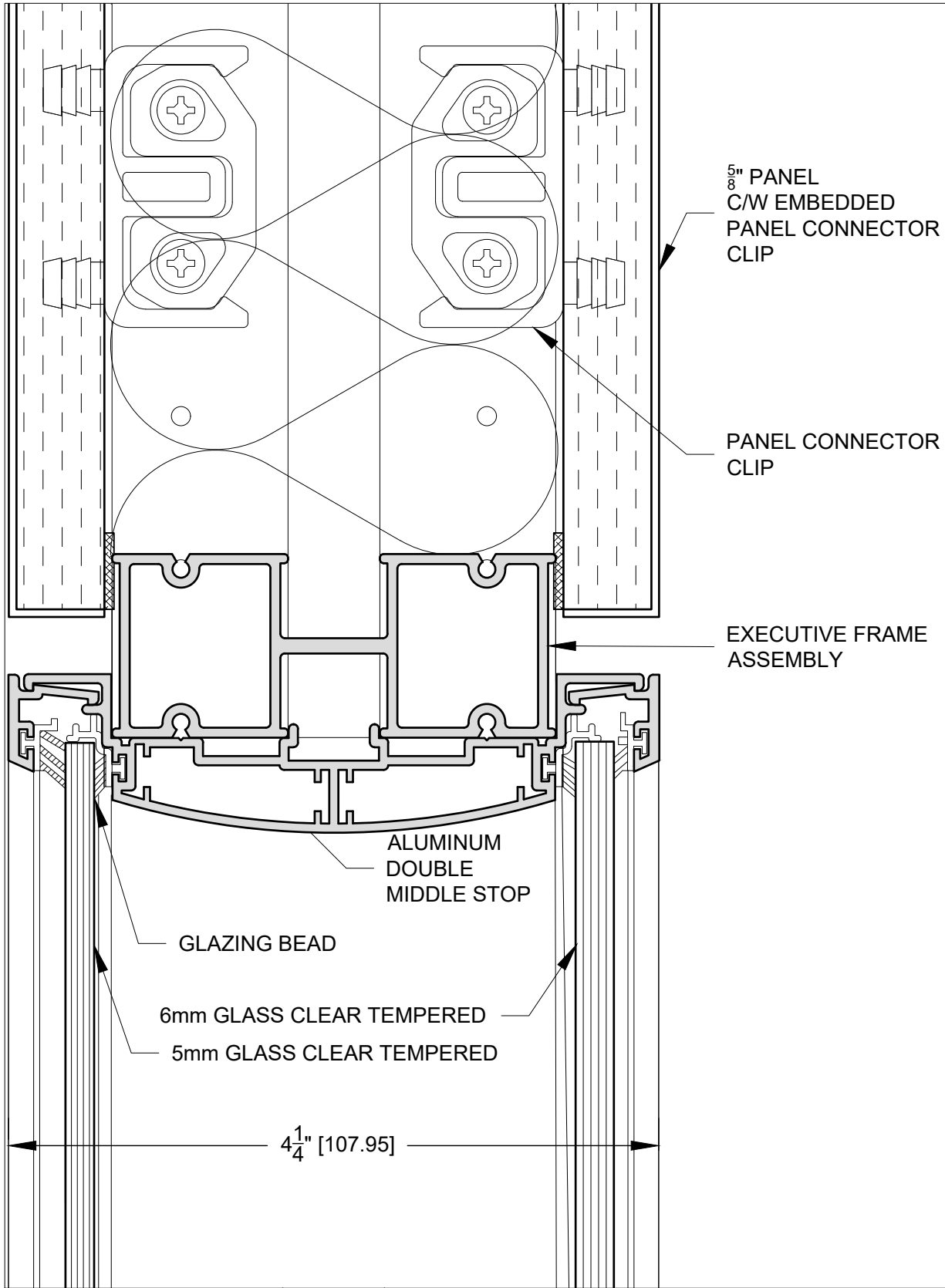

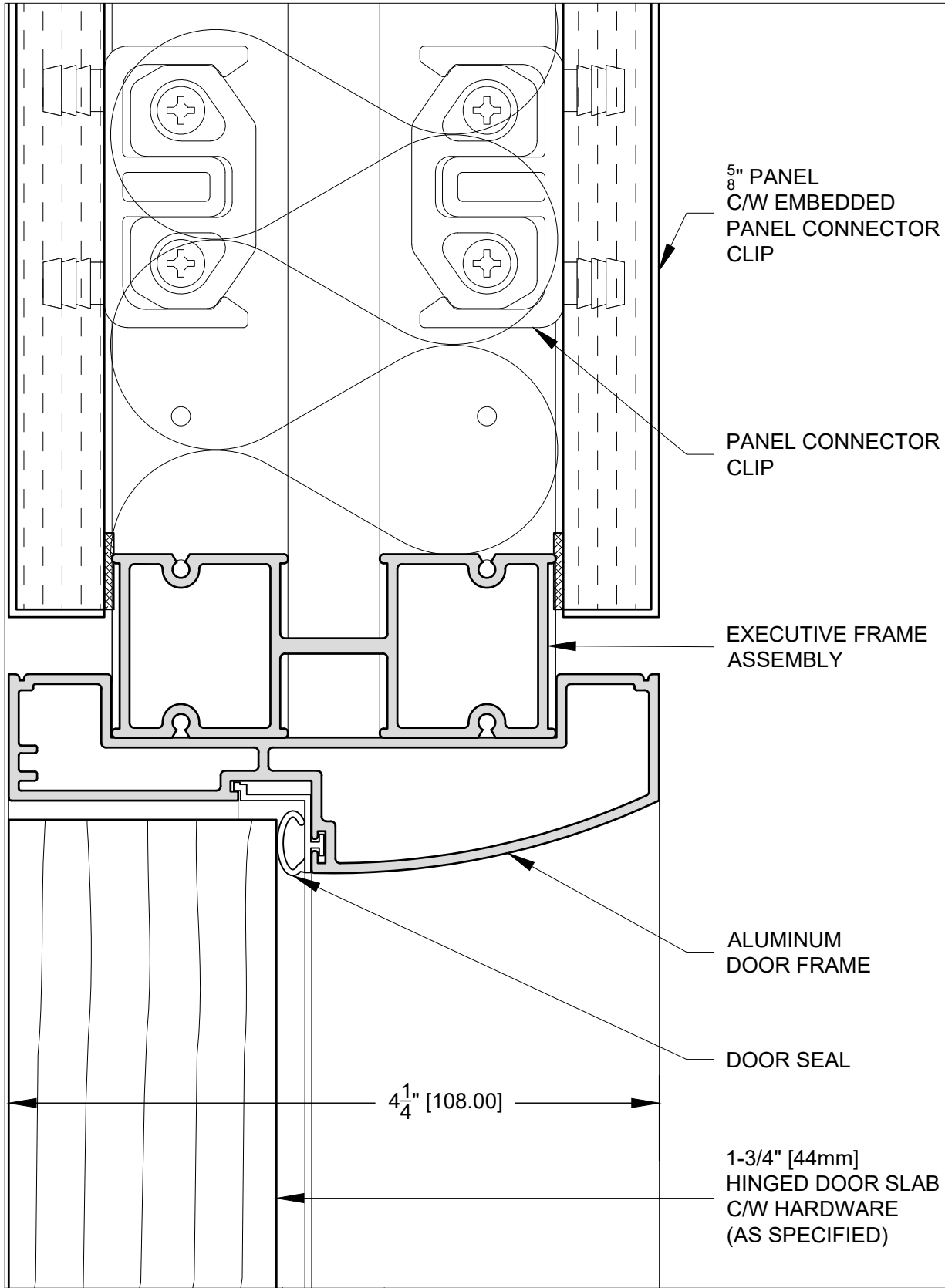



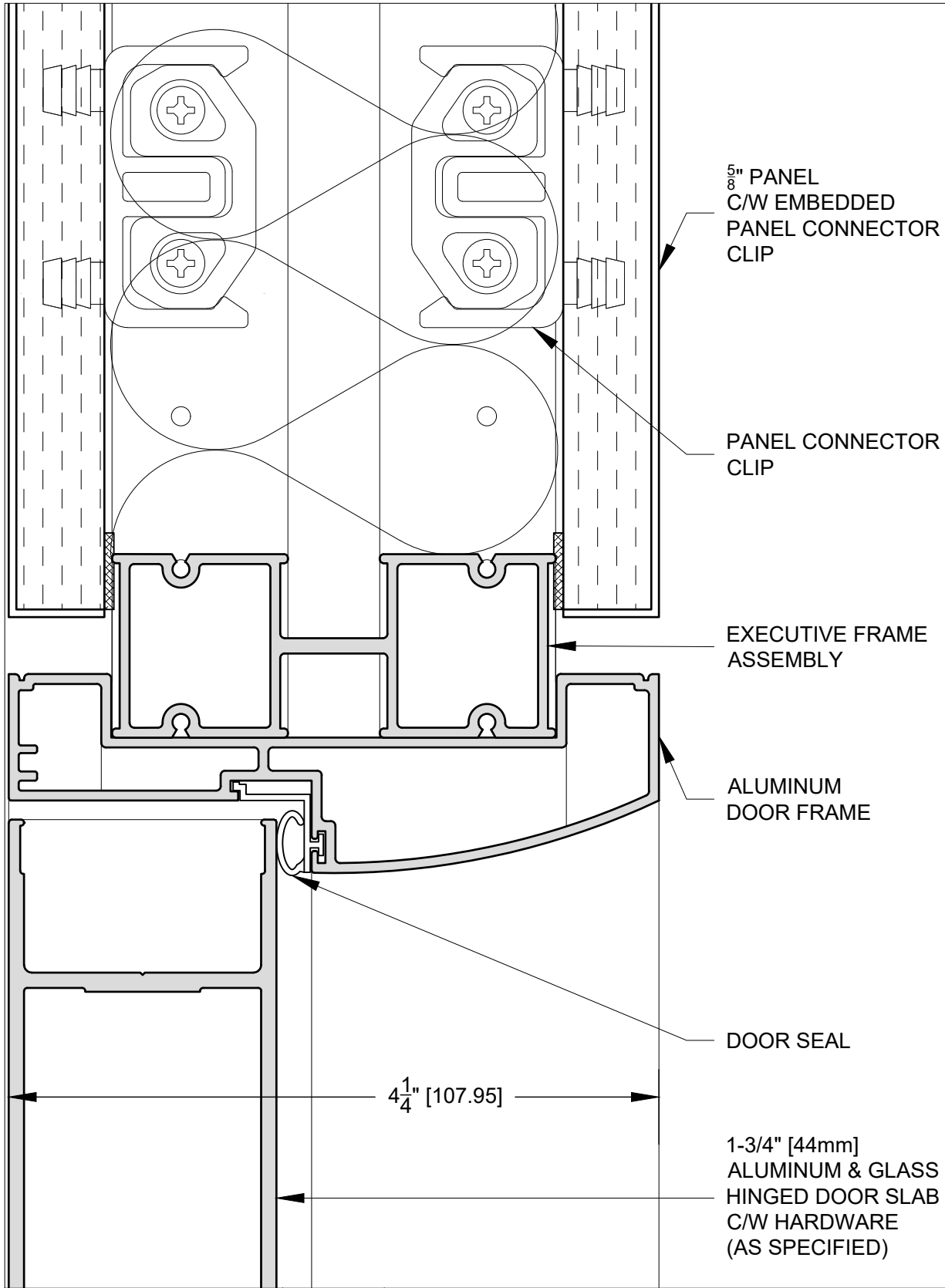

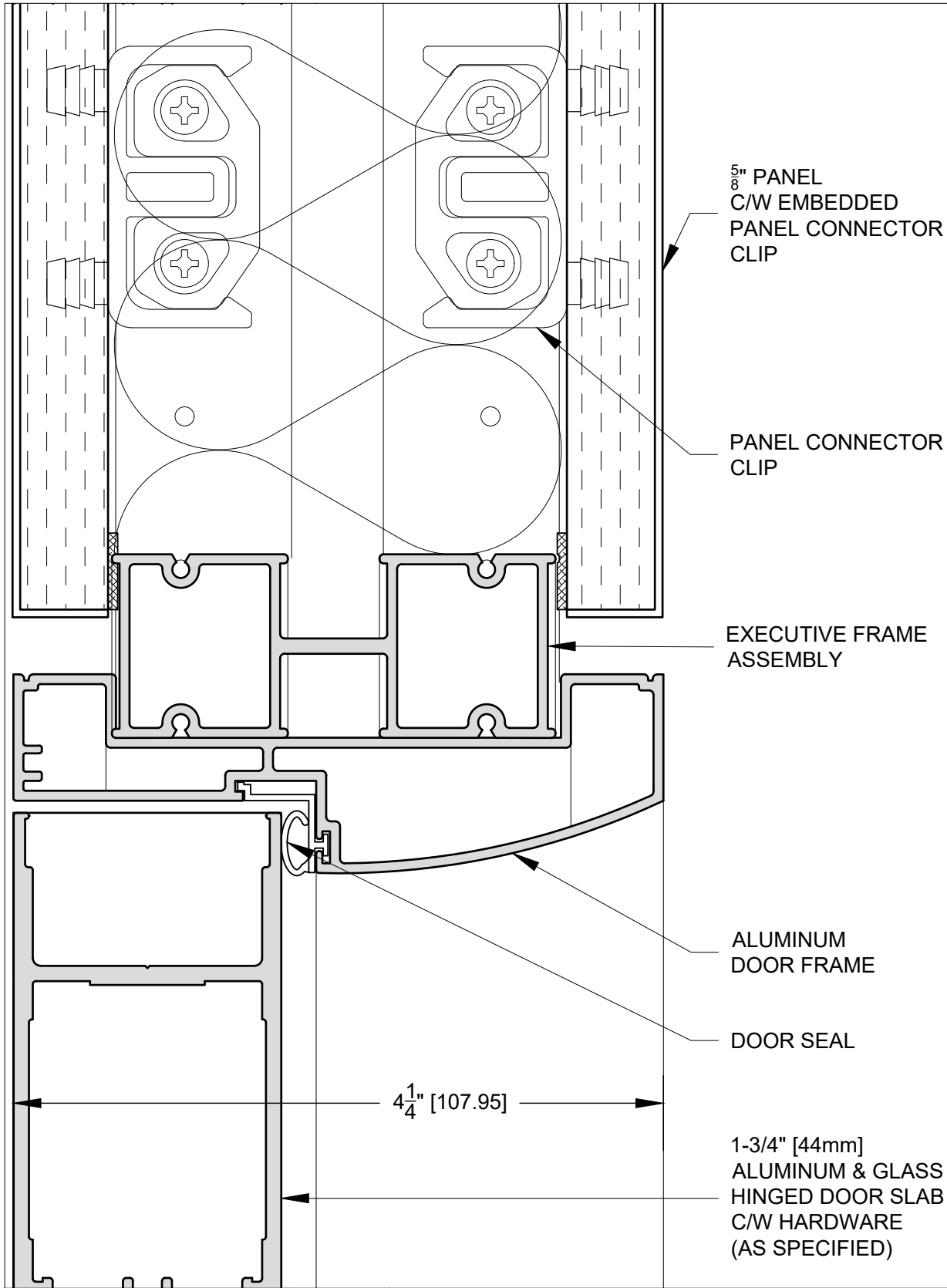

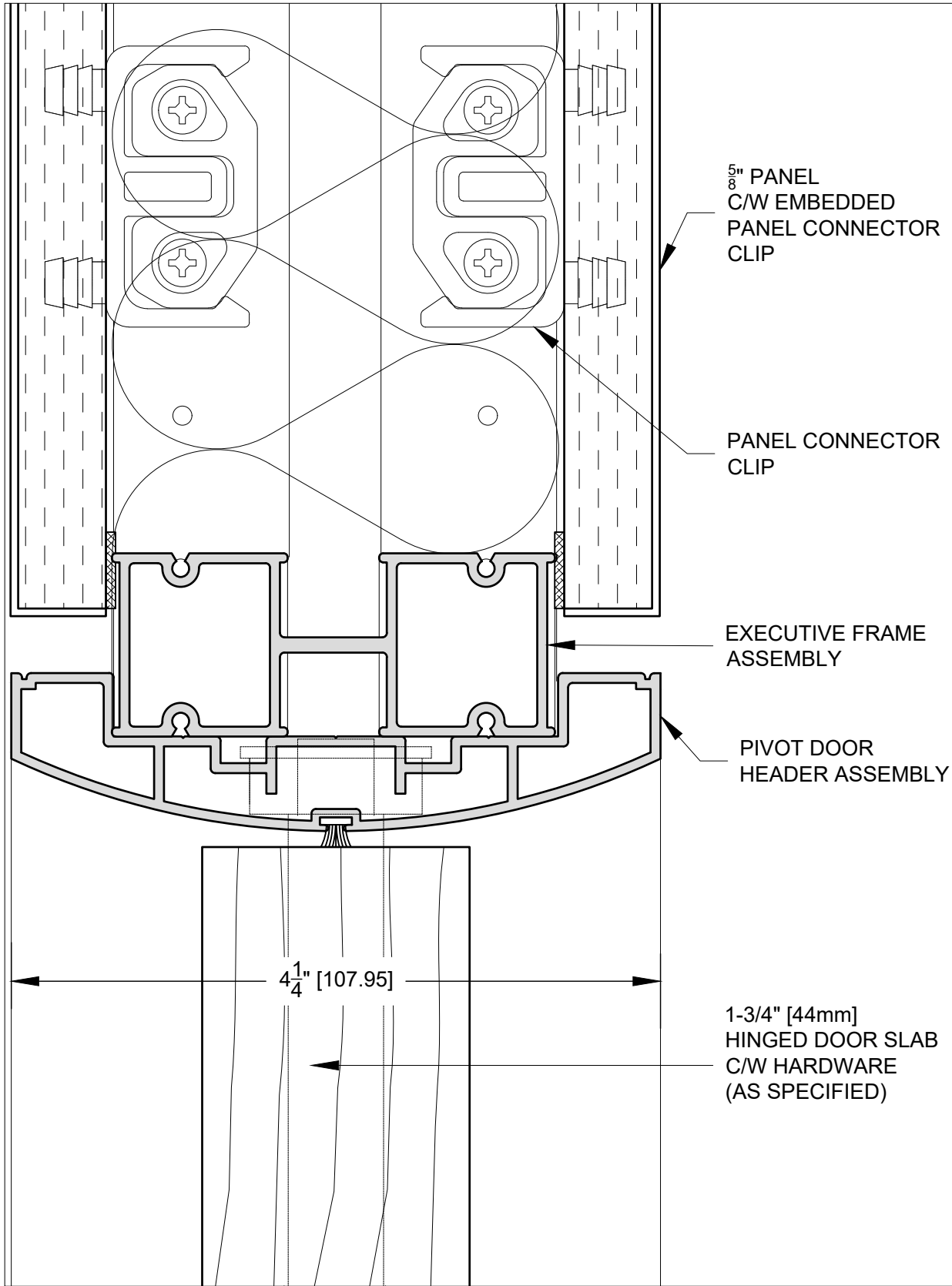

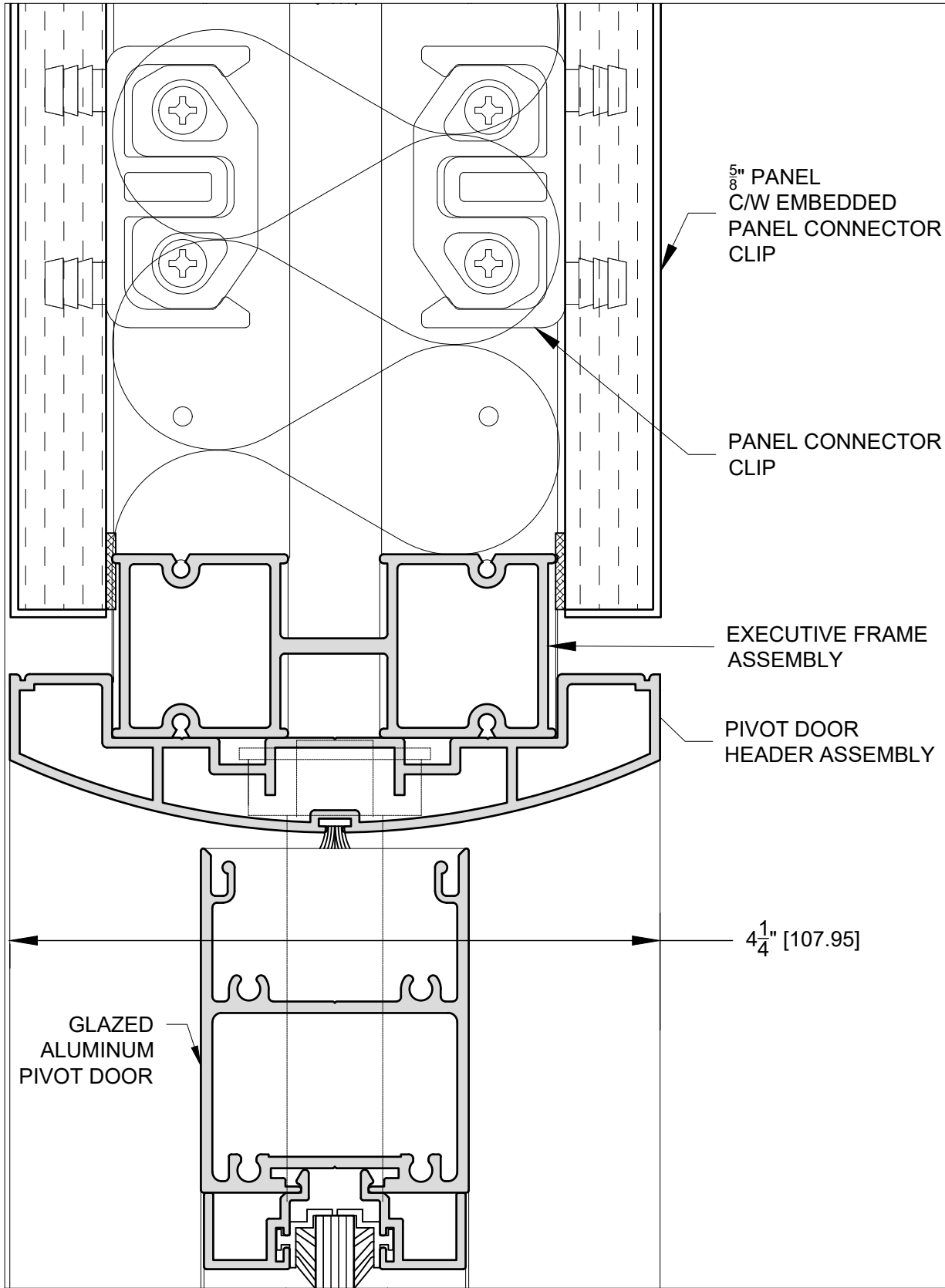

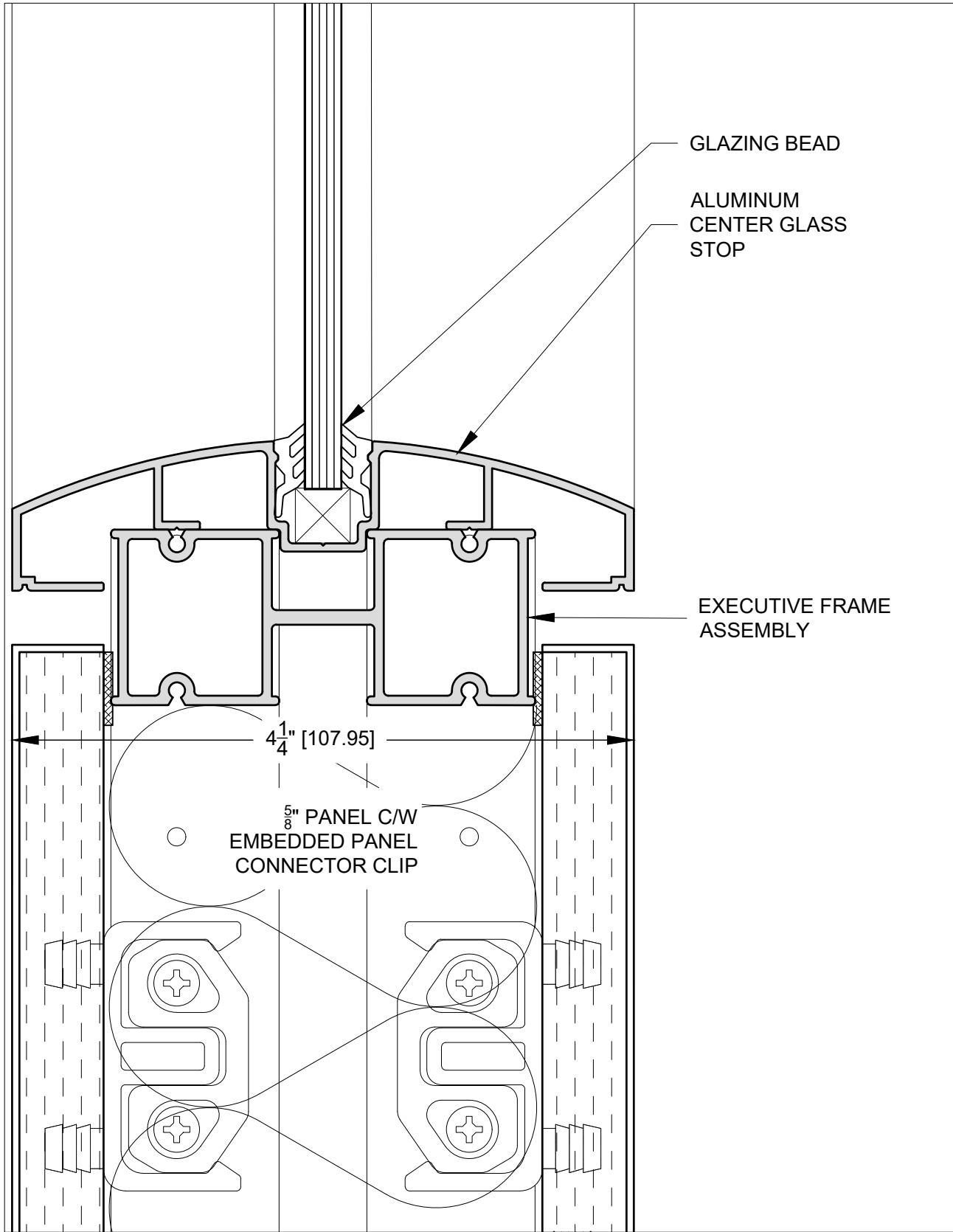

GLAZING BEAD

ALUMINUM  
CENTER GLASS  
STOP

EXECUTIVE FRAME  
ASSEMBLY

4 1/4" [107.95]

5/8" PANEL C/W  
EMBEDDED PANEL  
CONNECTOR CLIP

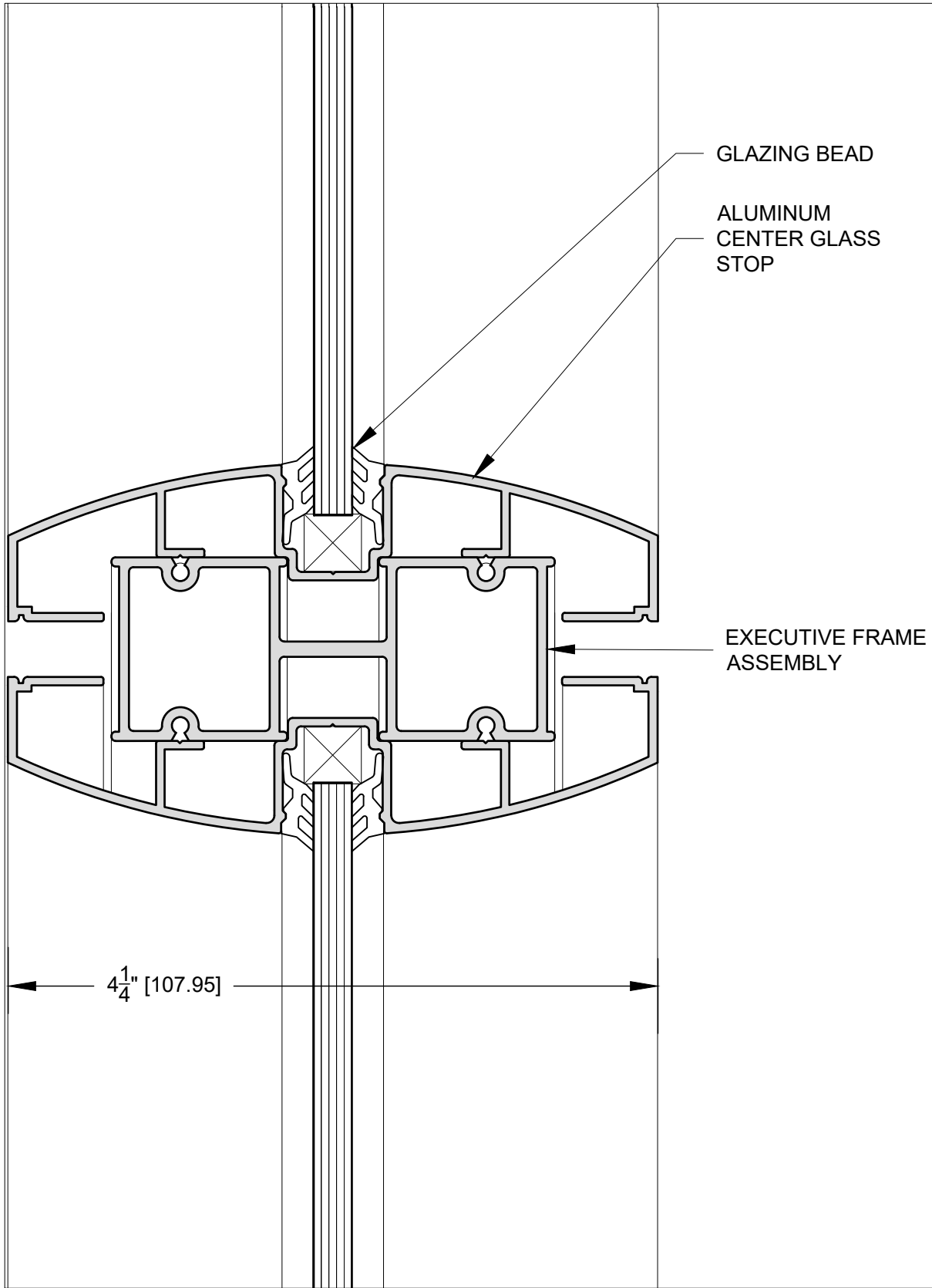

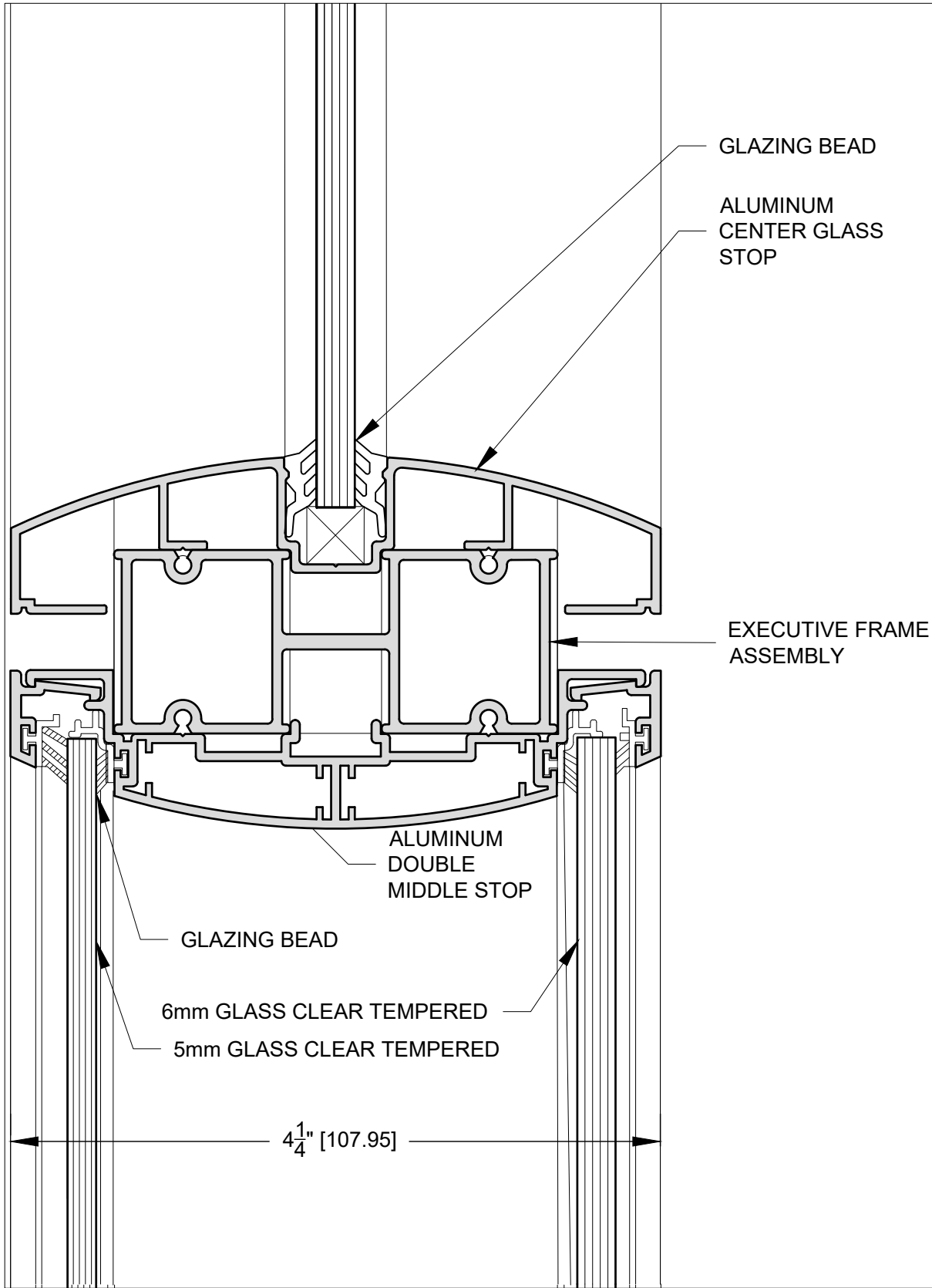

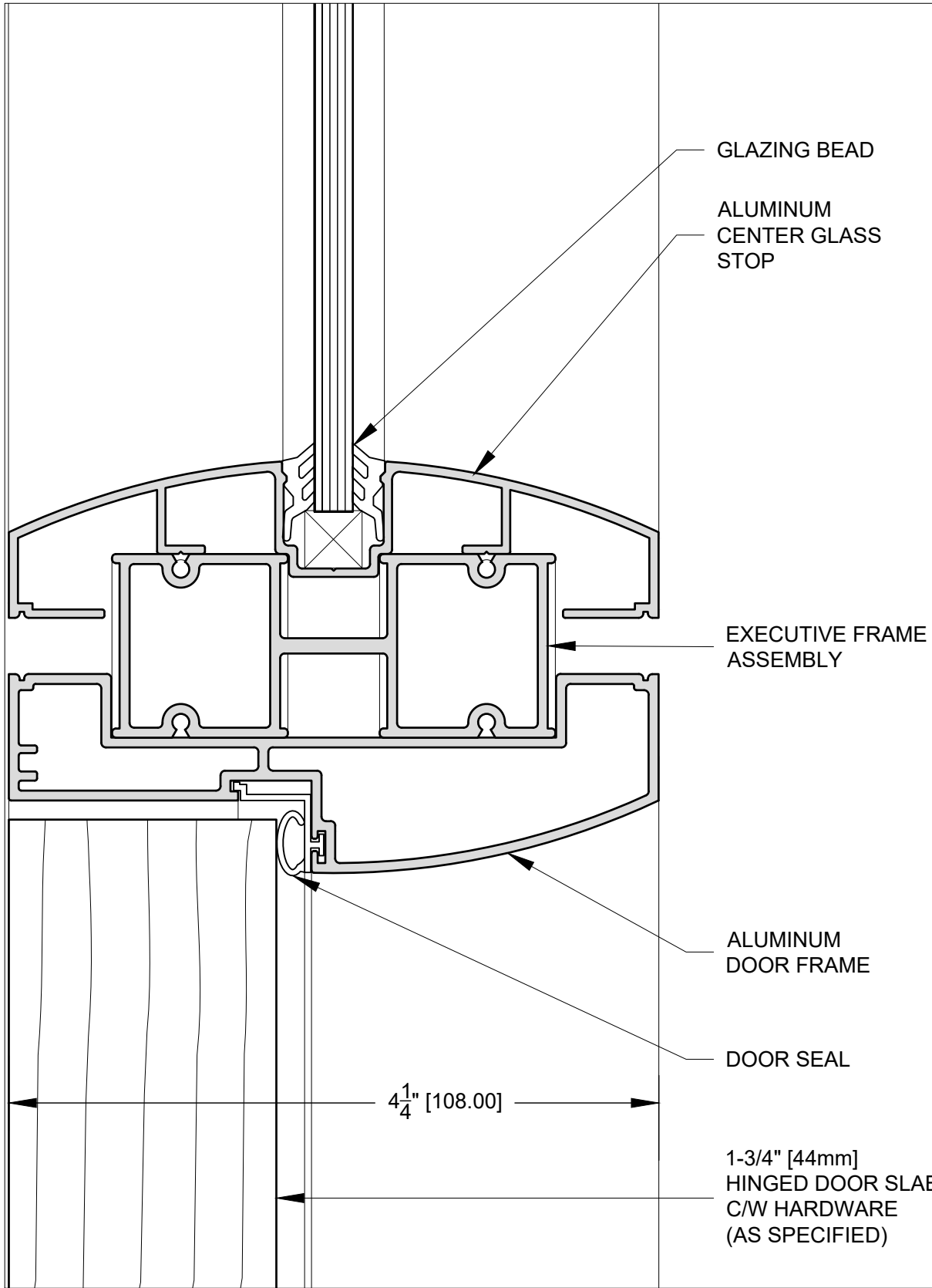



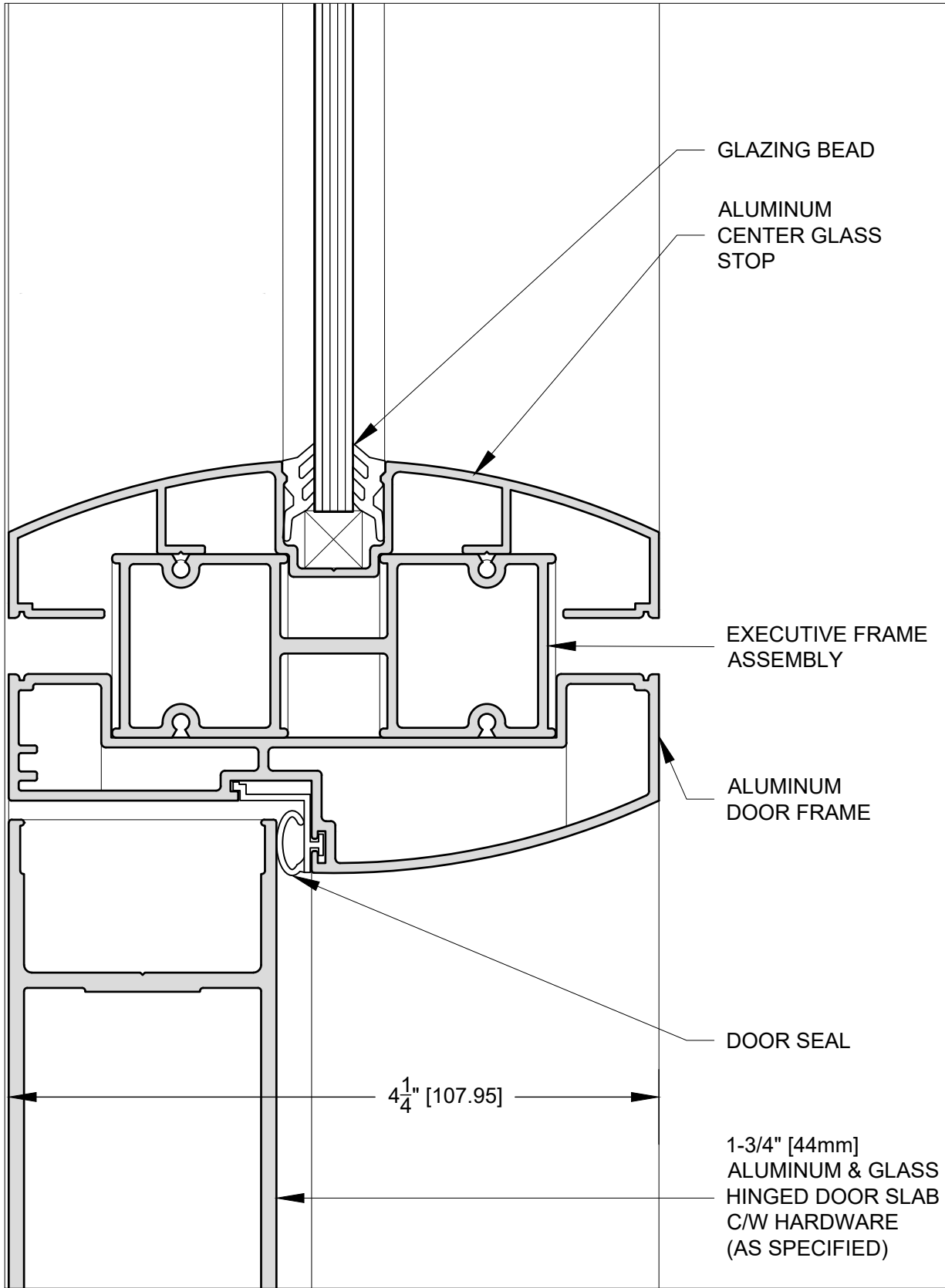

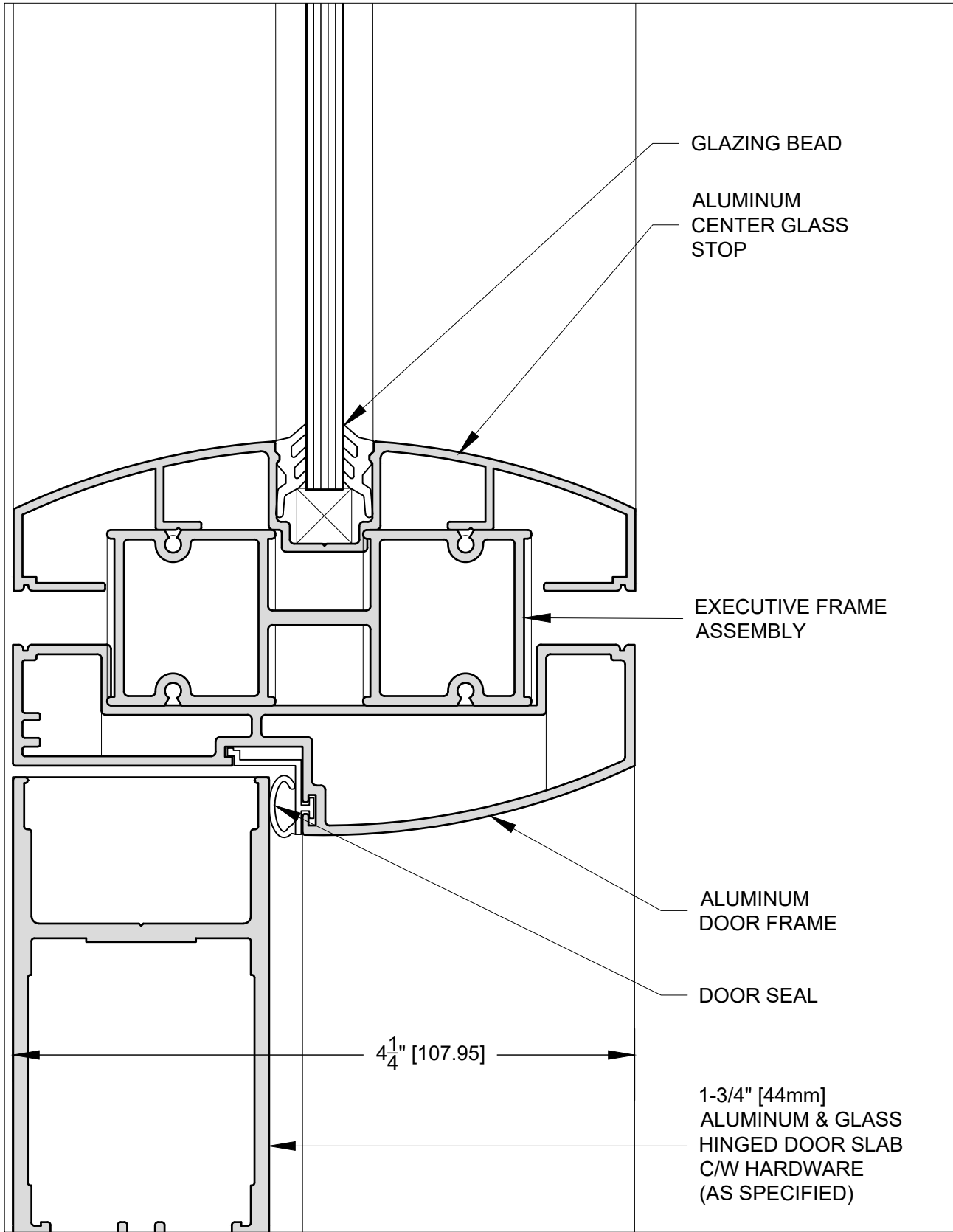

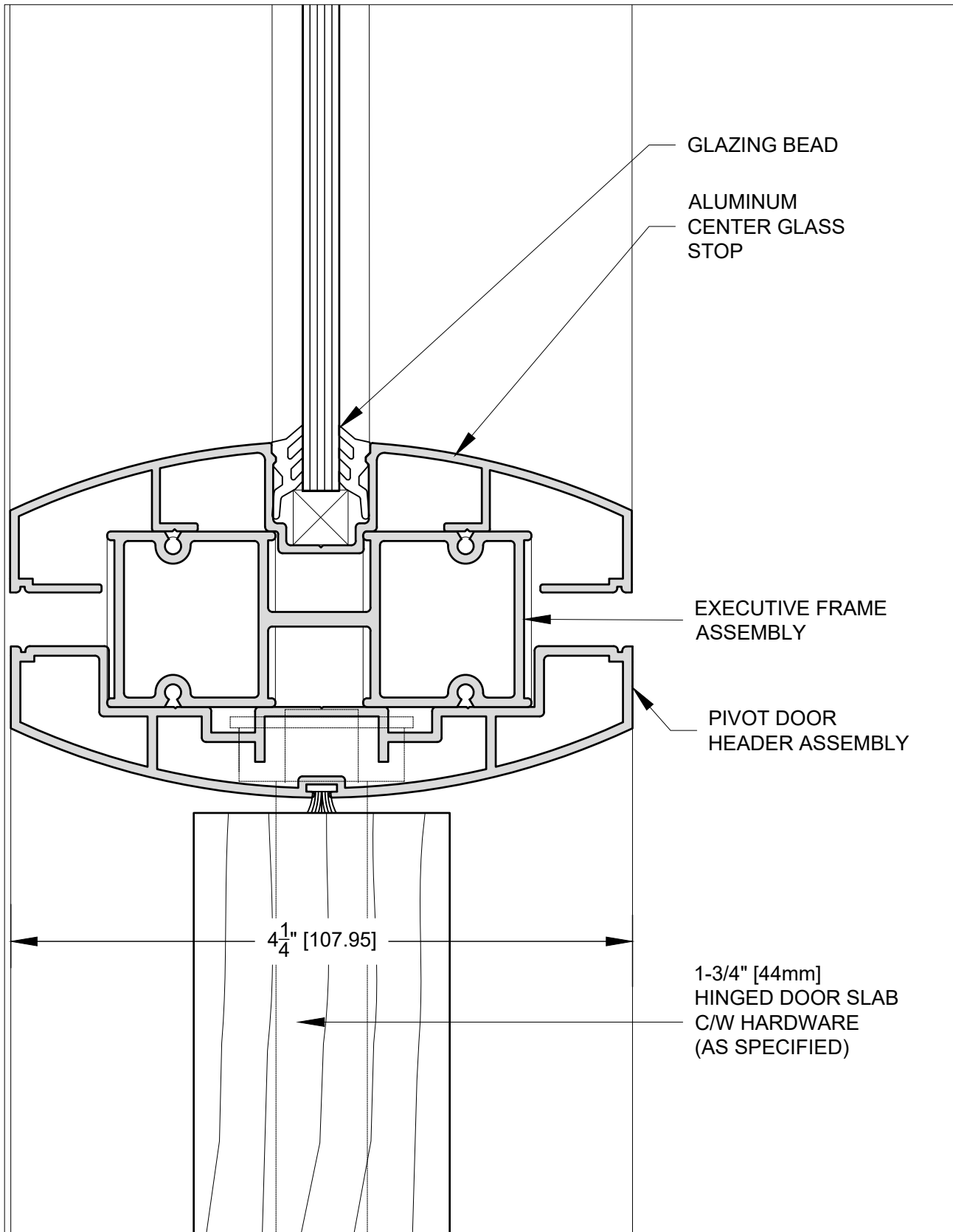

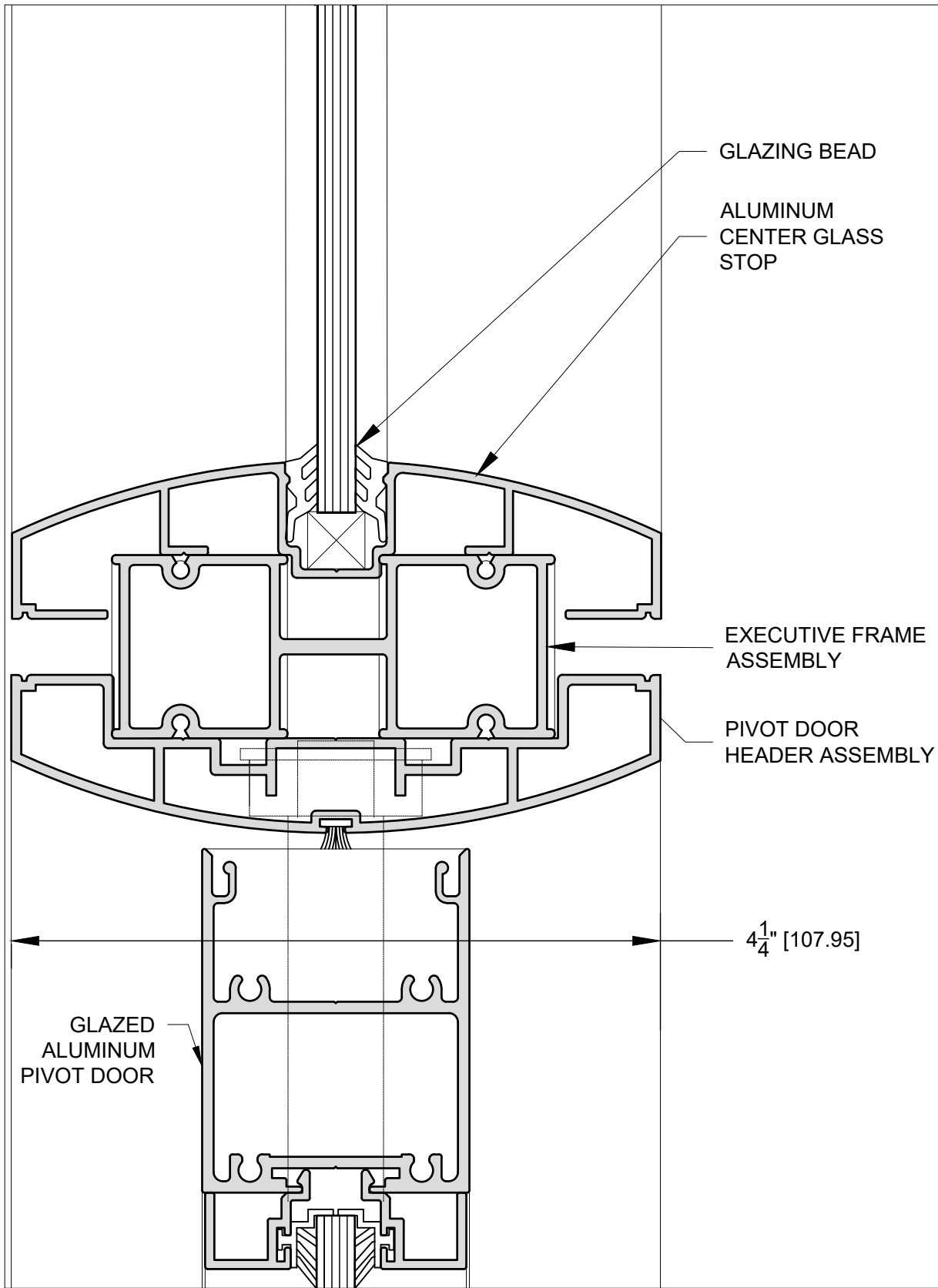

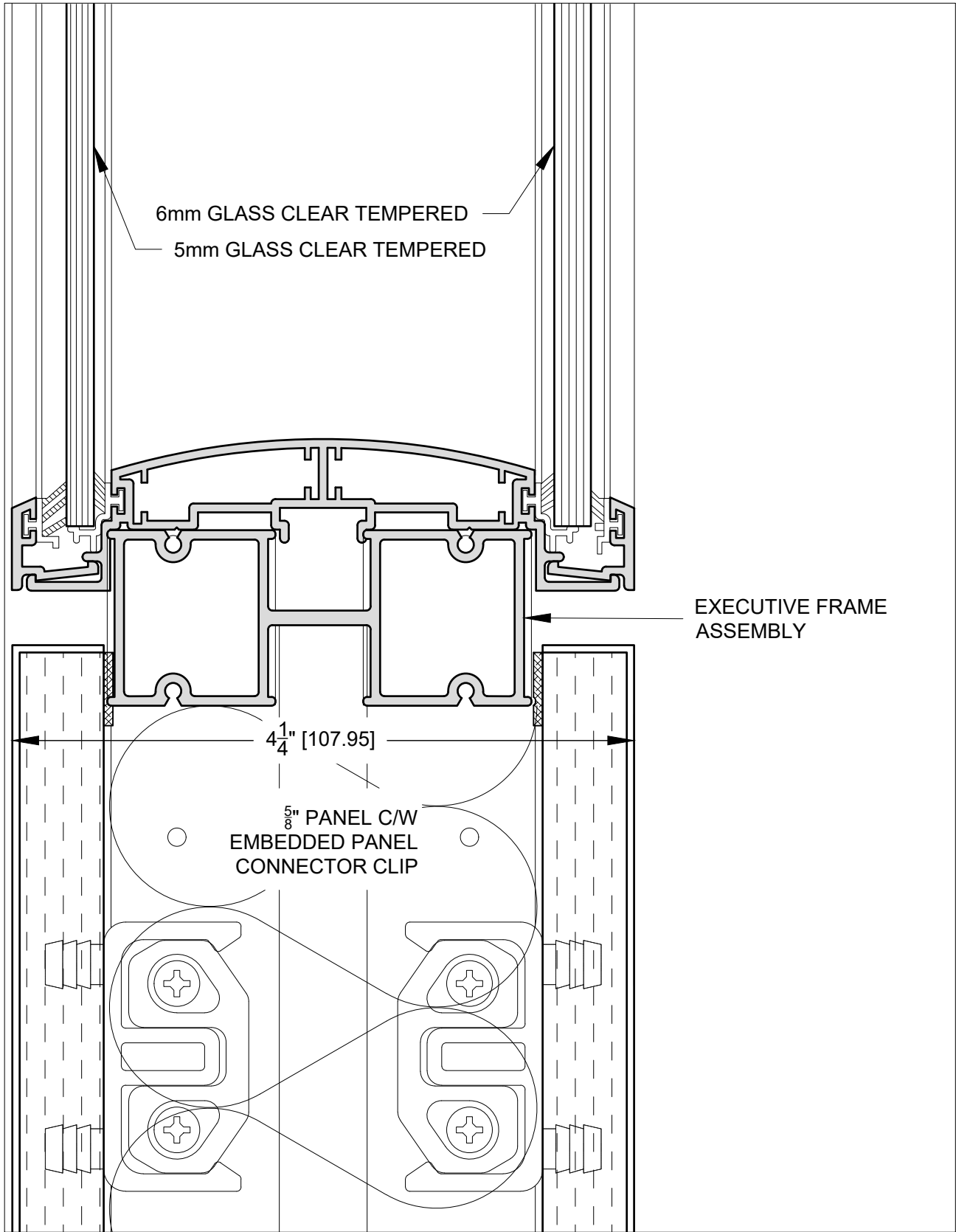

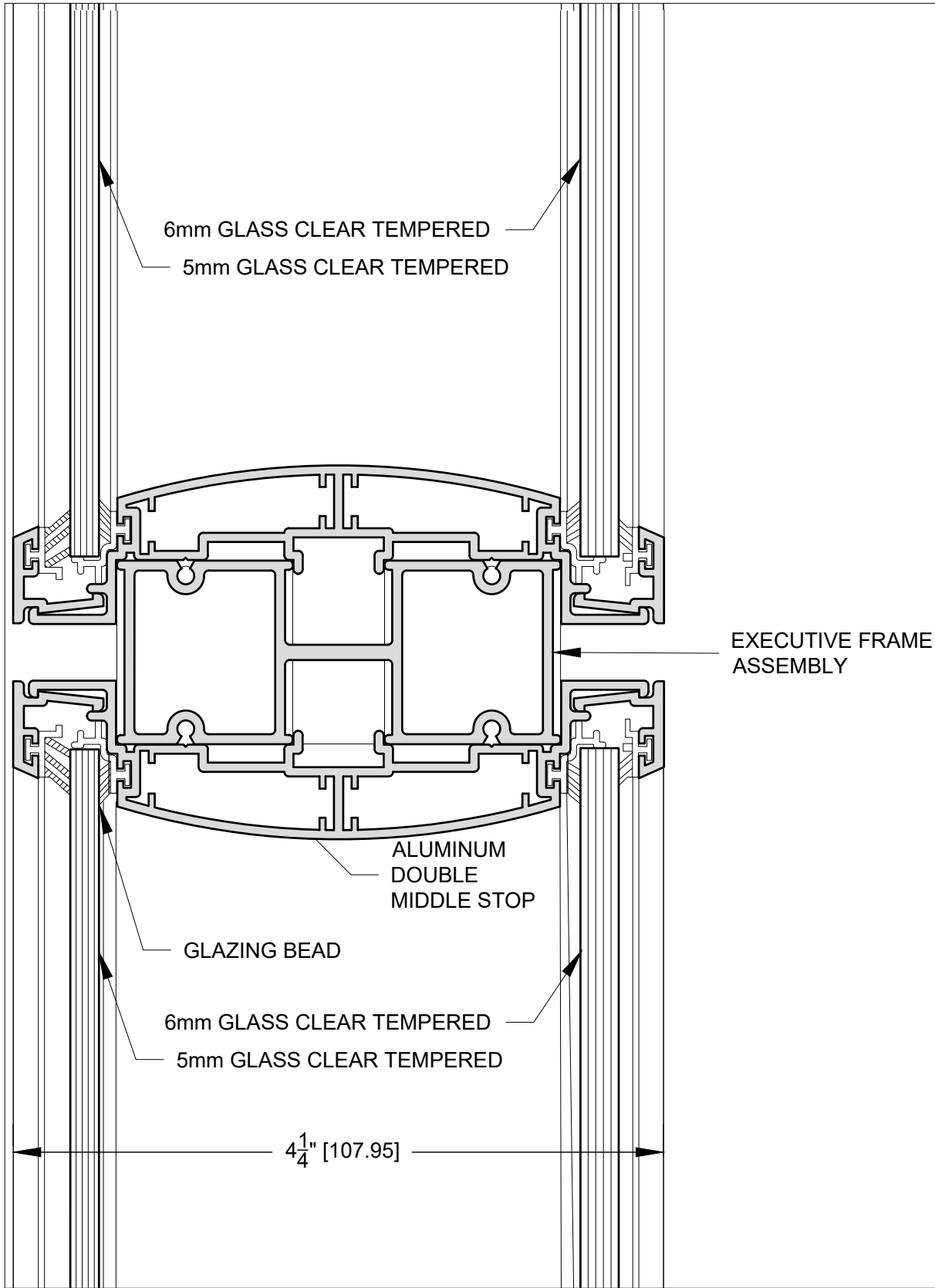

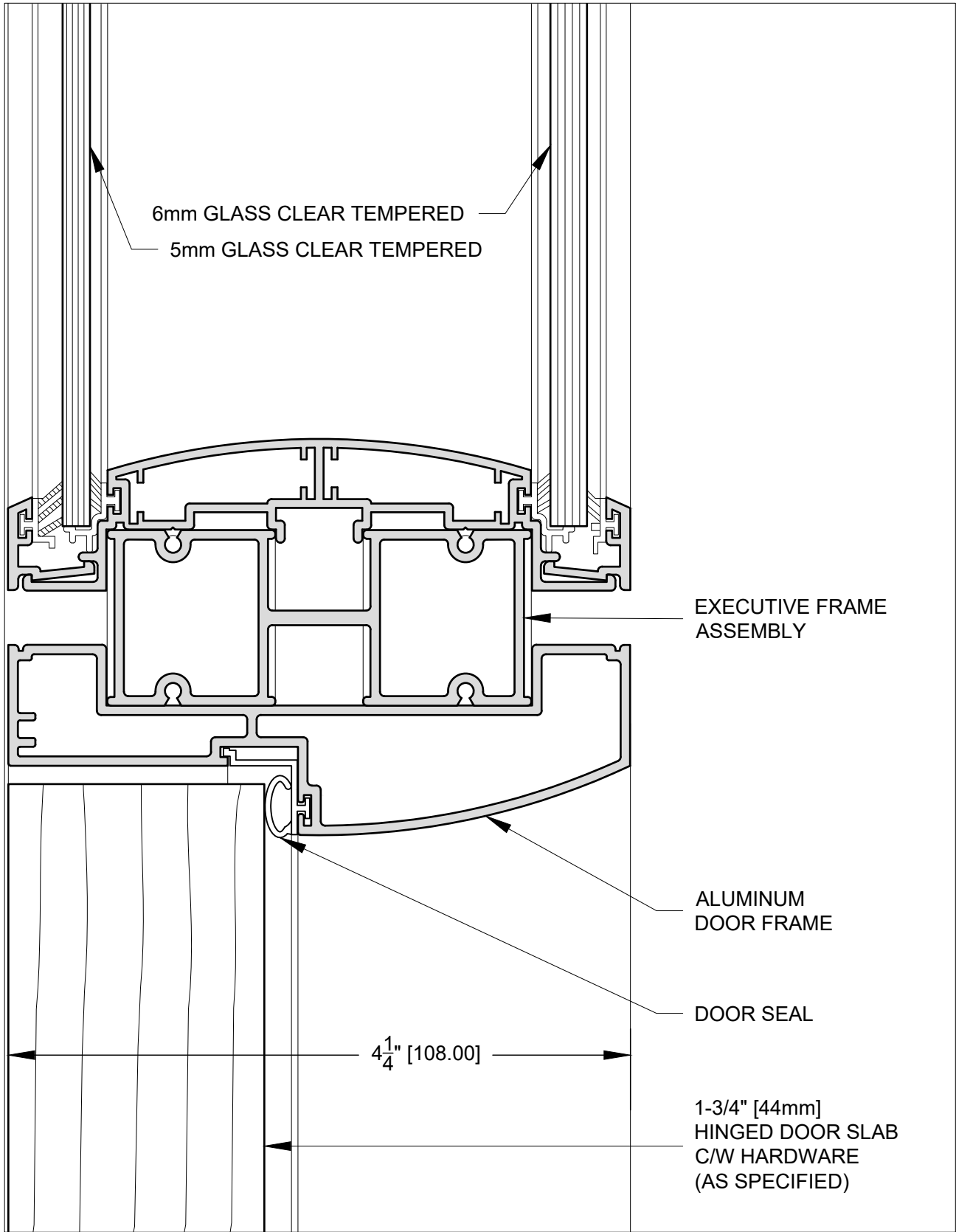

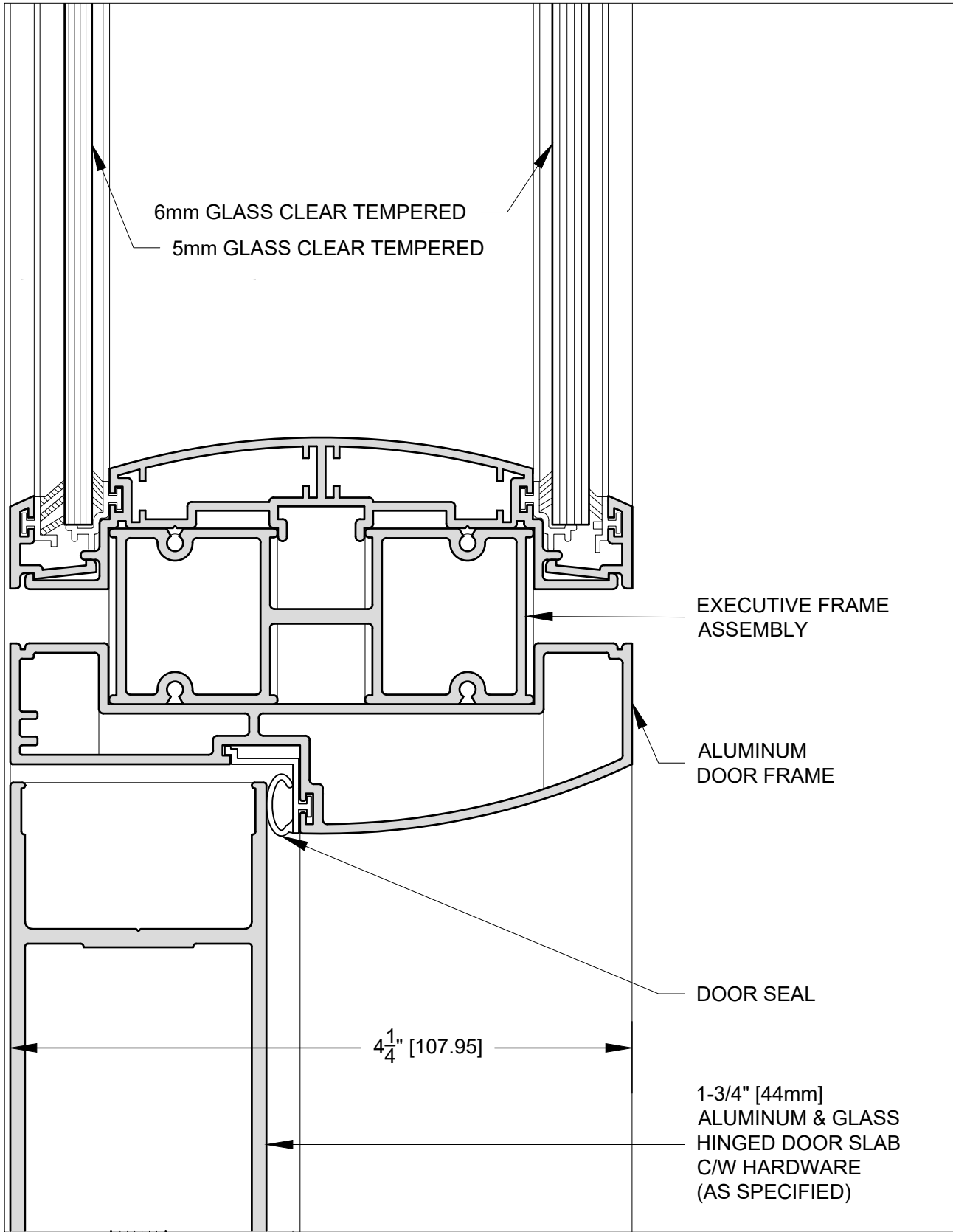



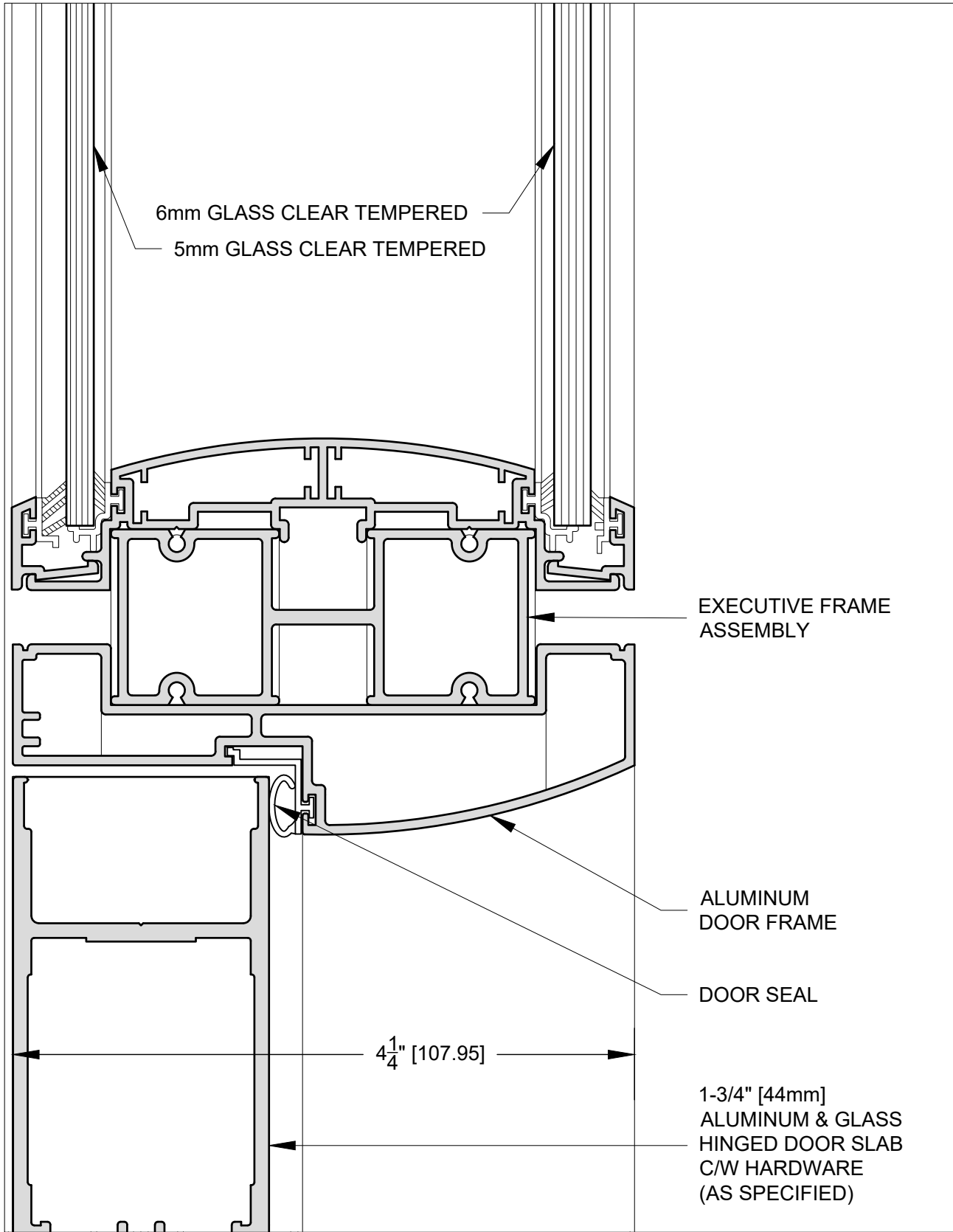

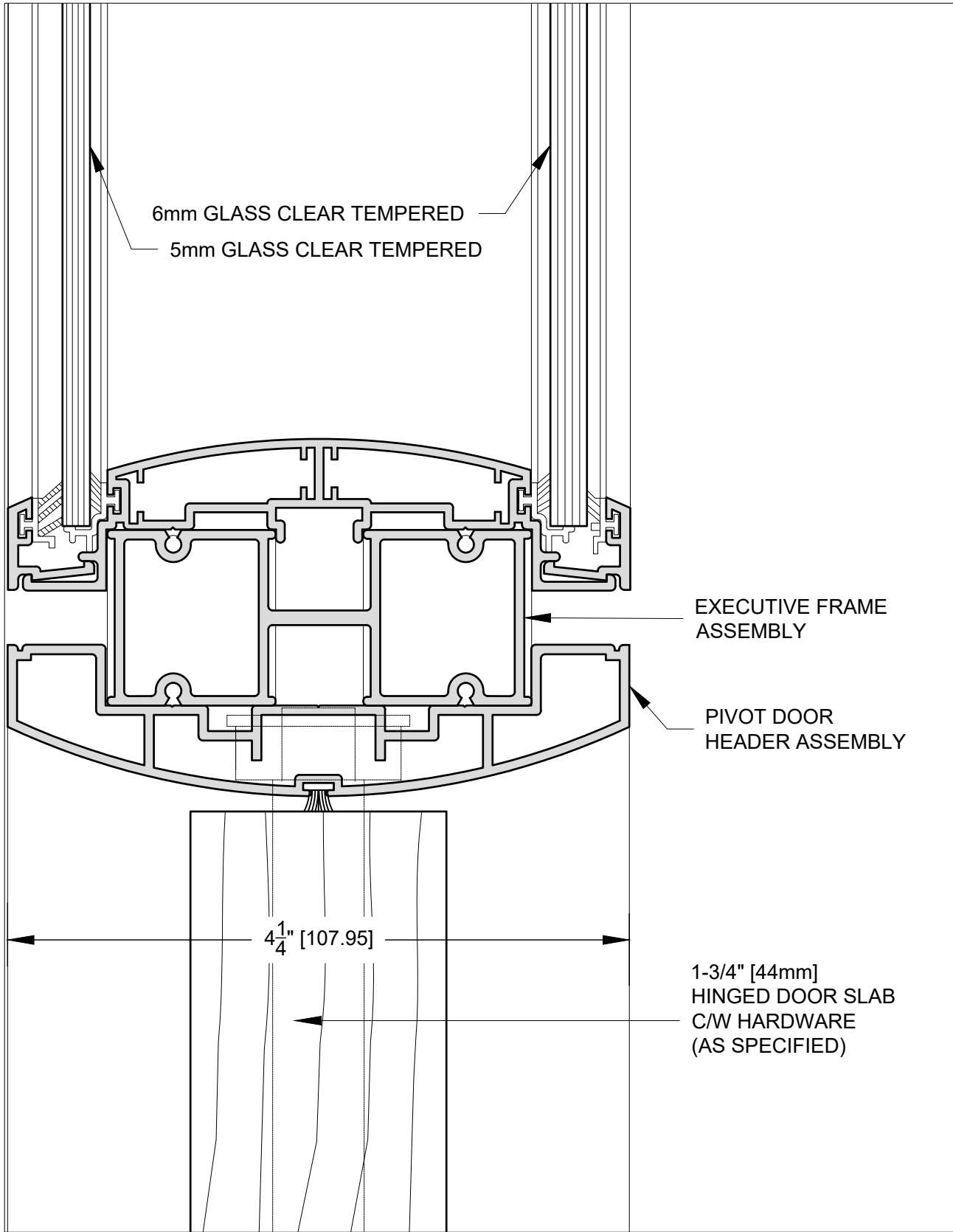

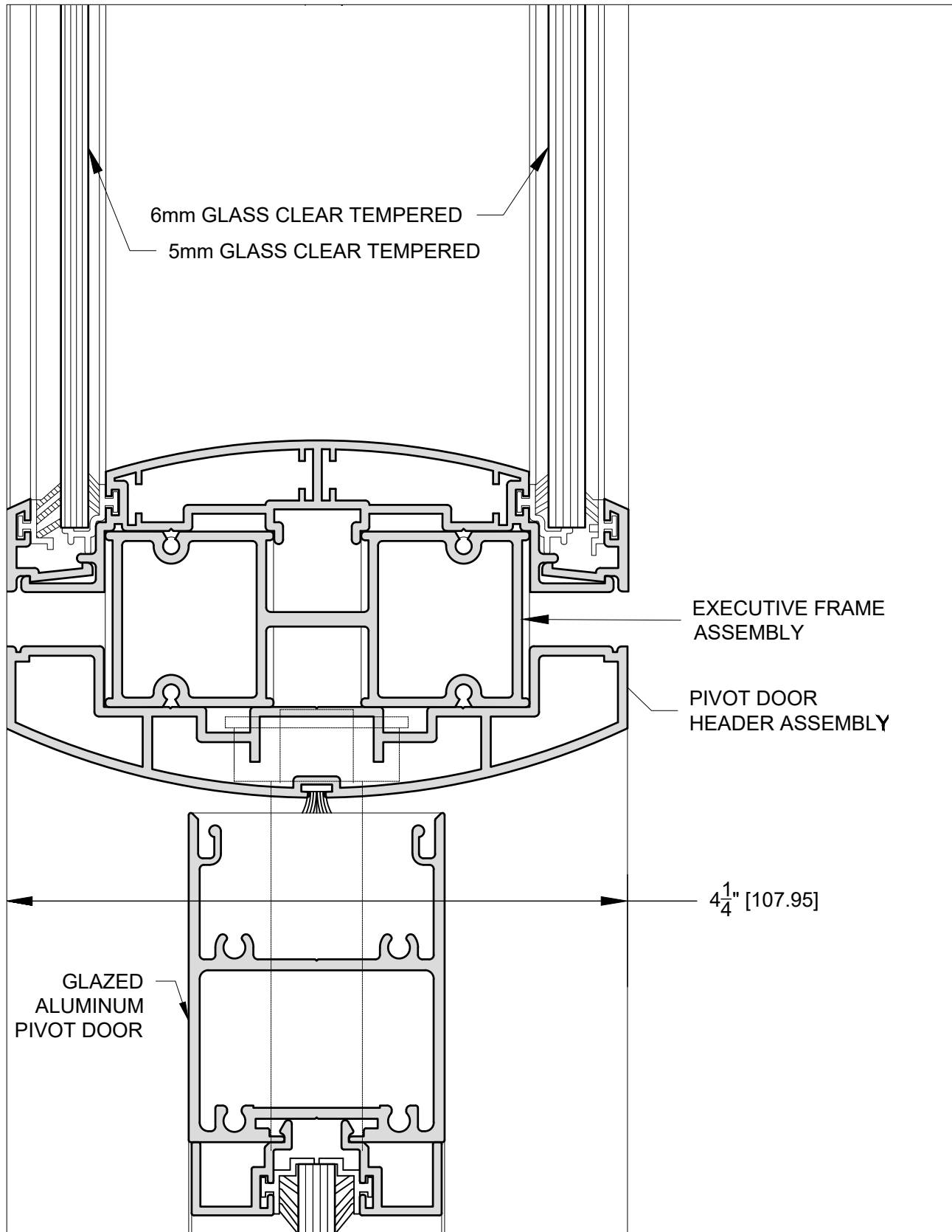

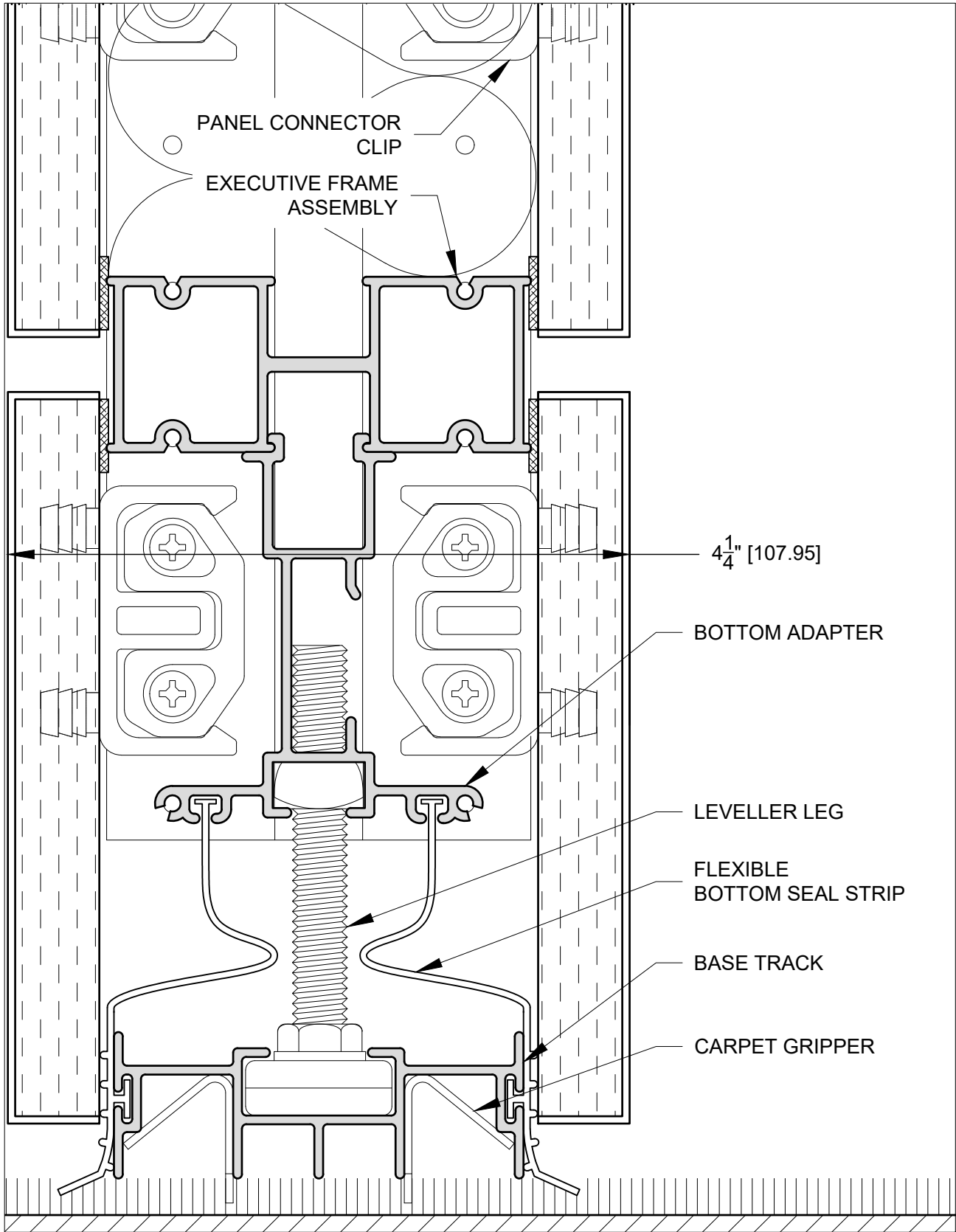

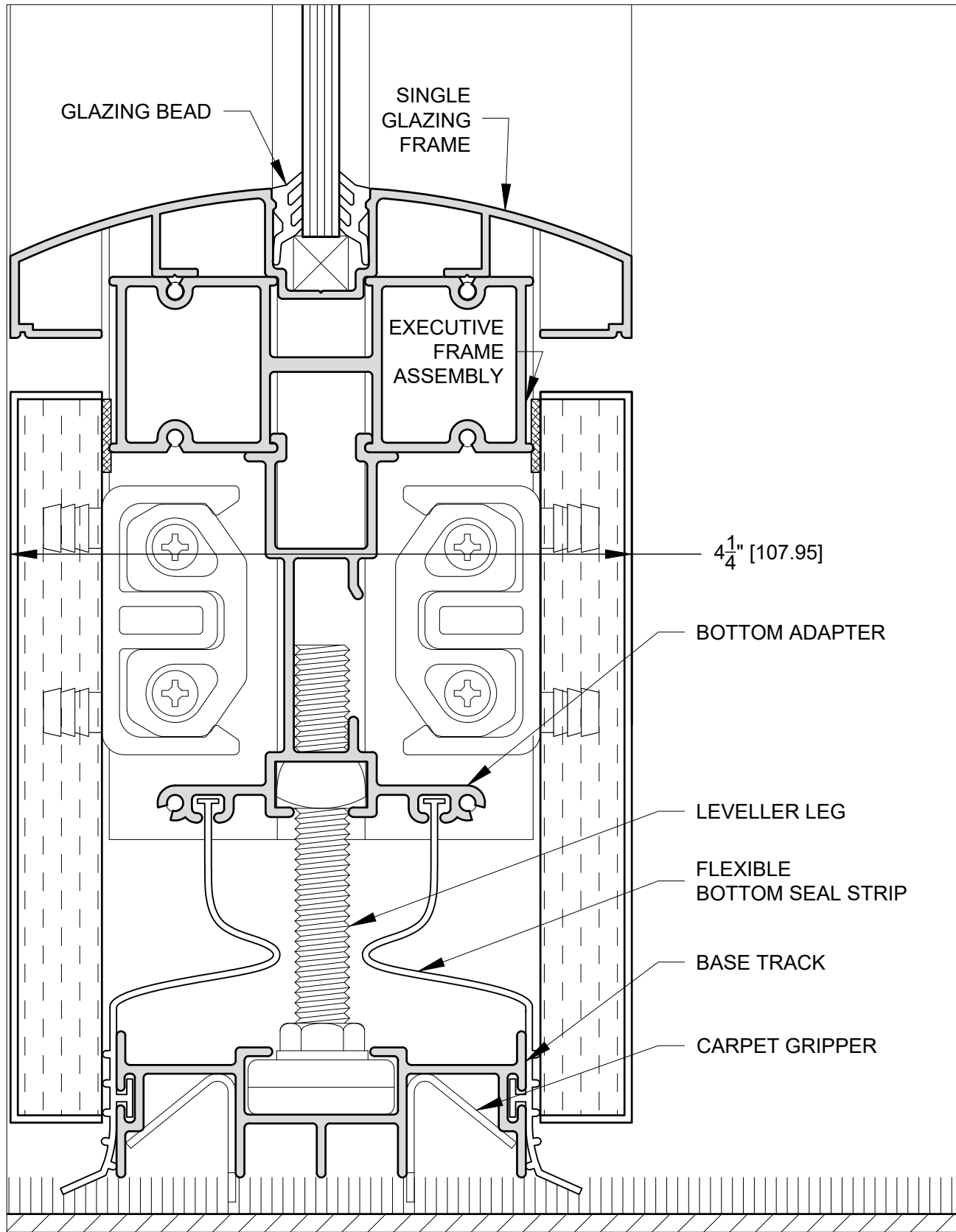

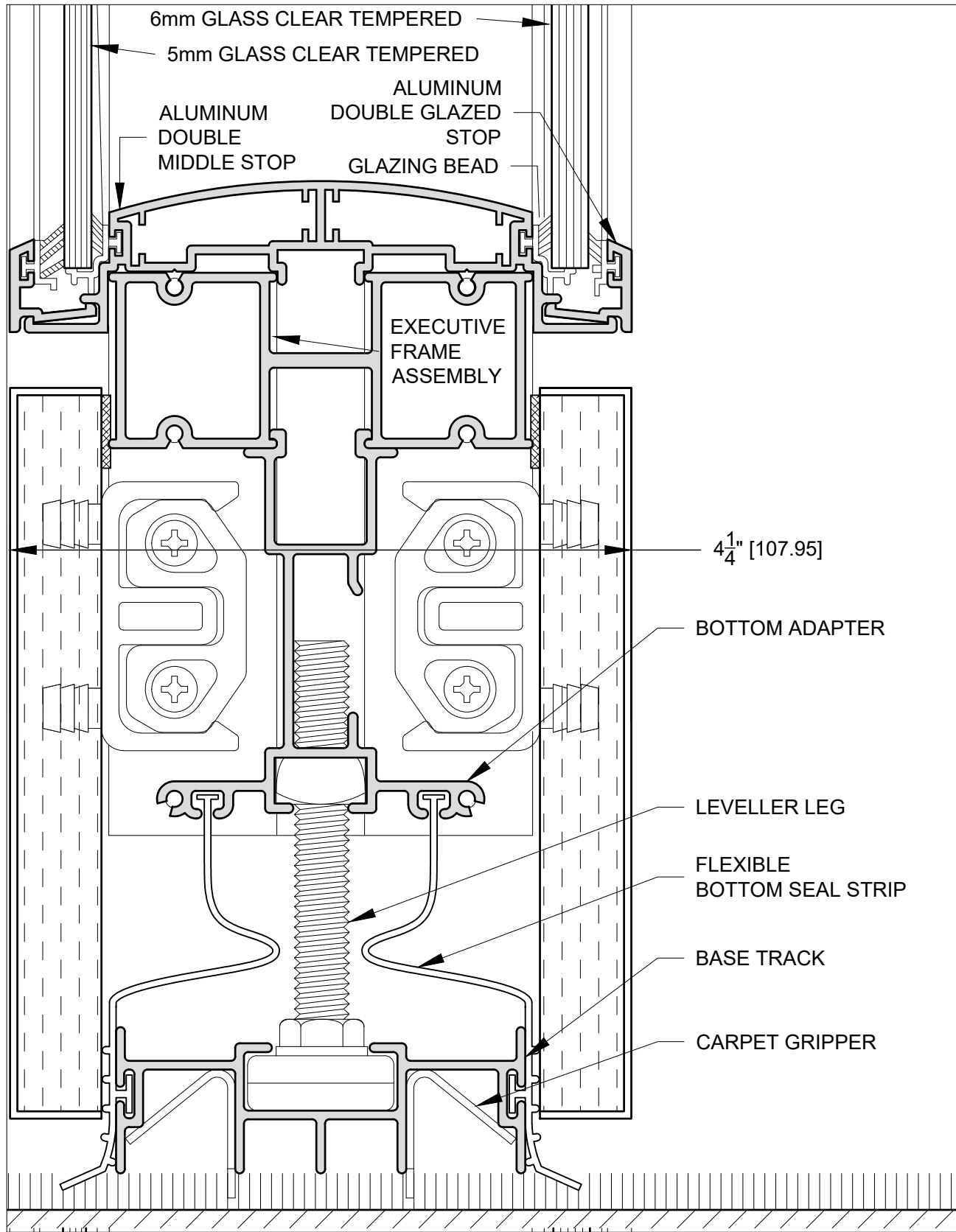

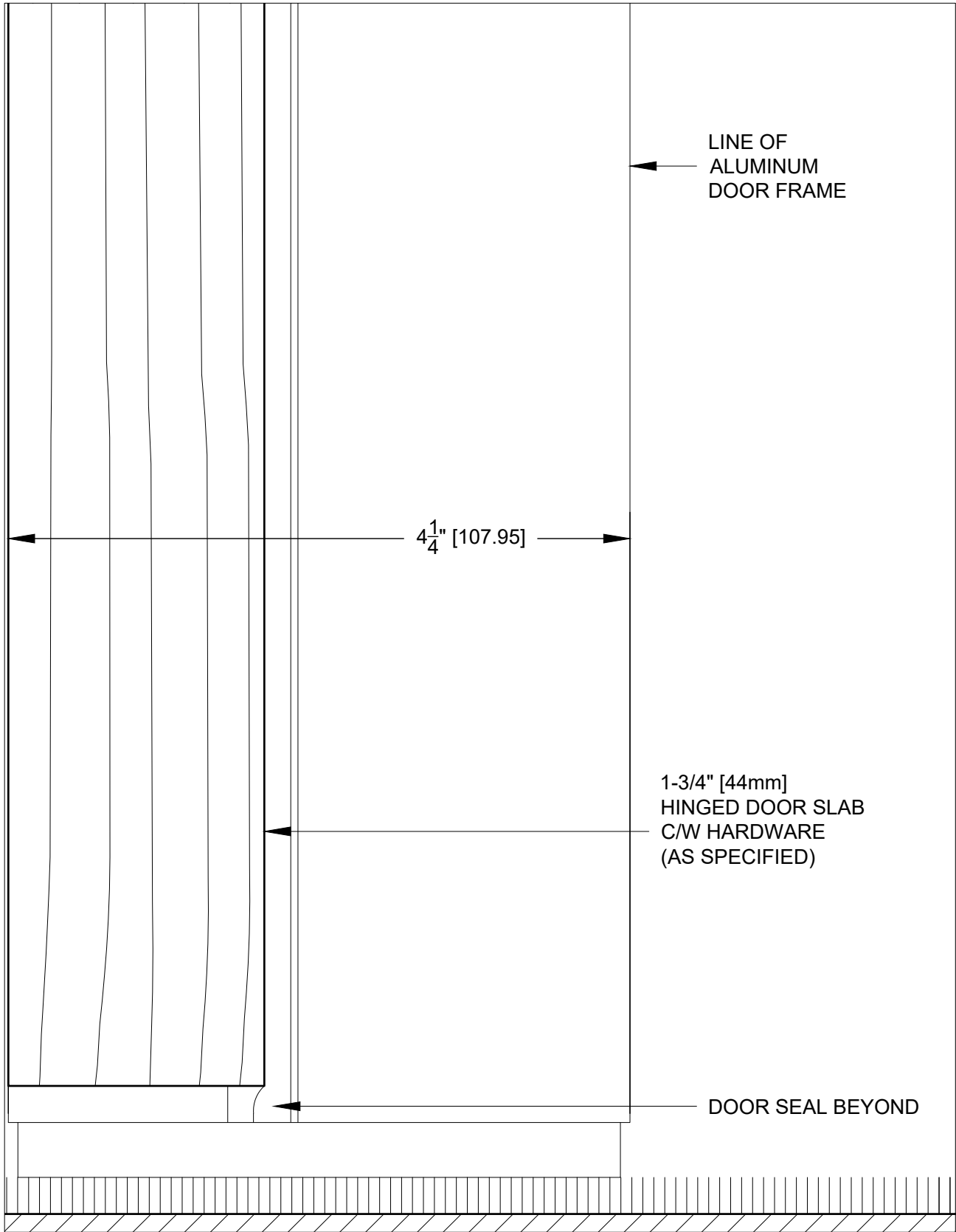

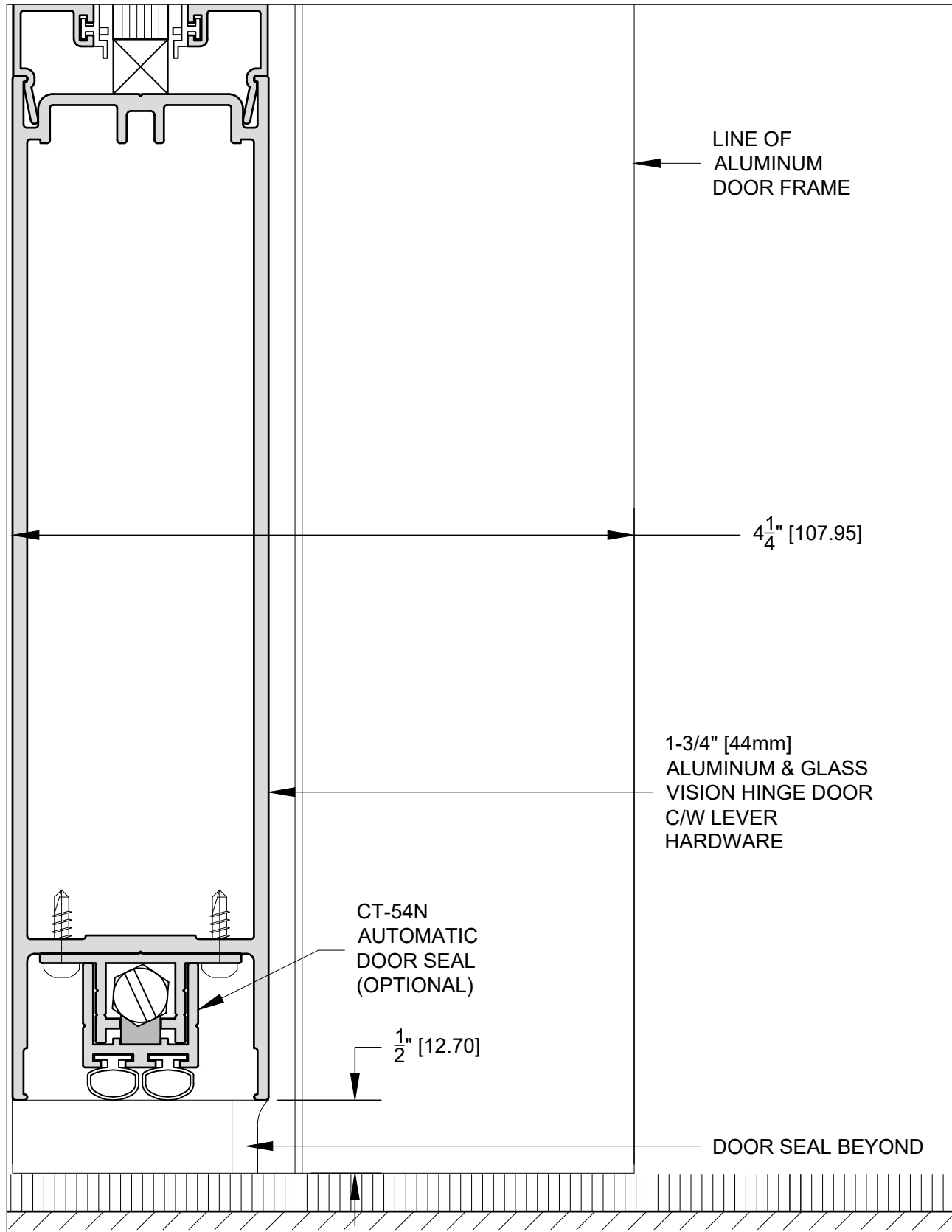



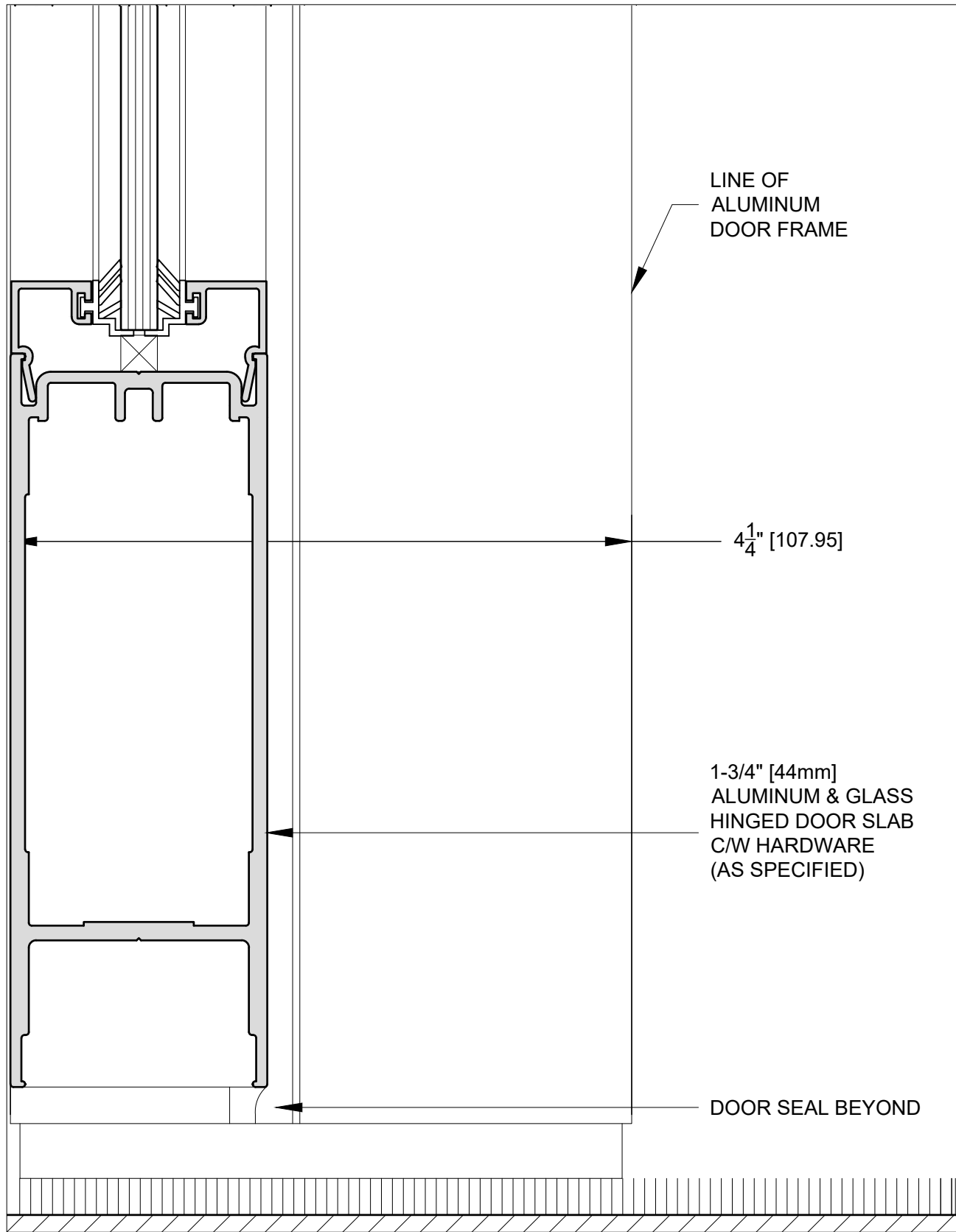

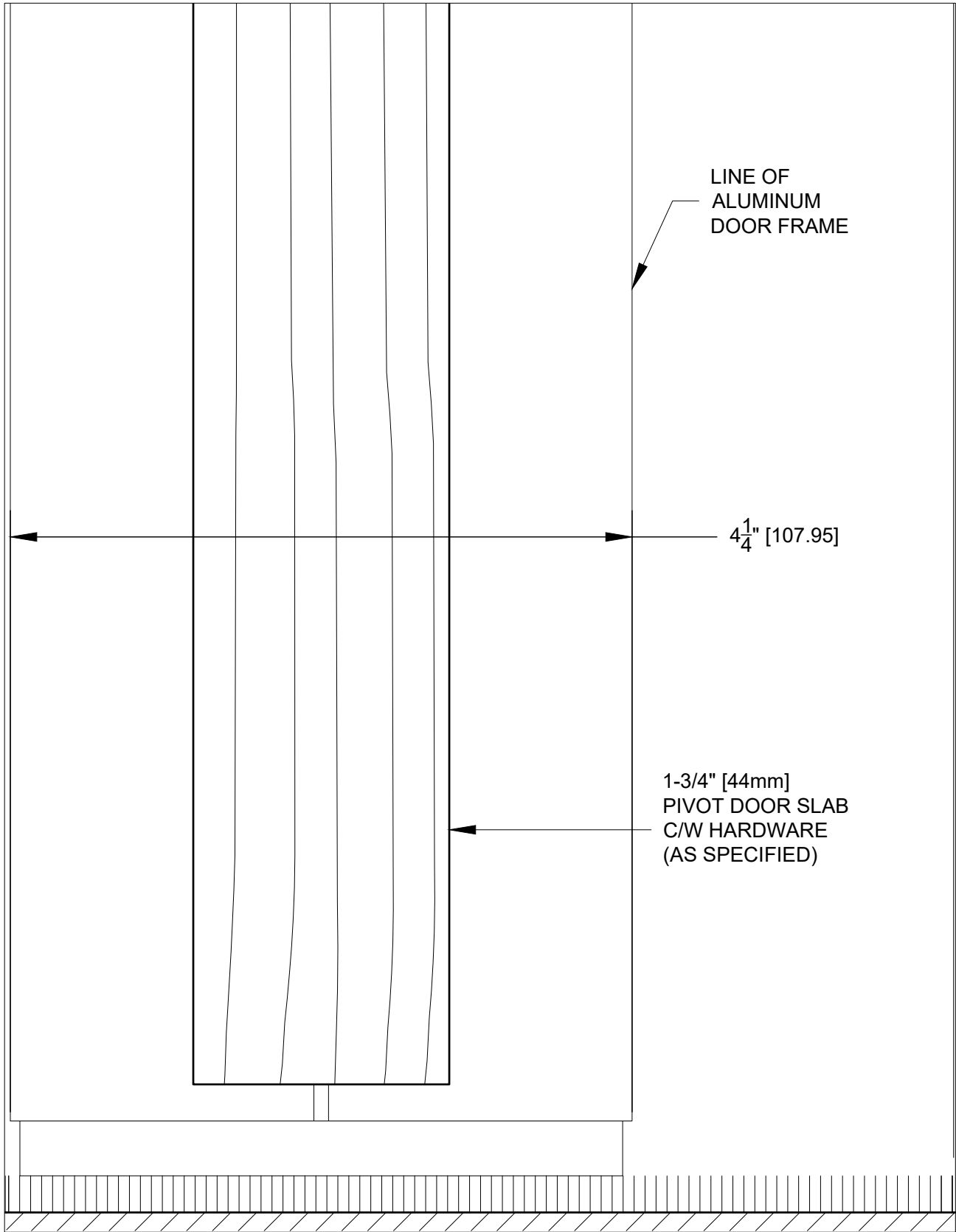

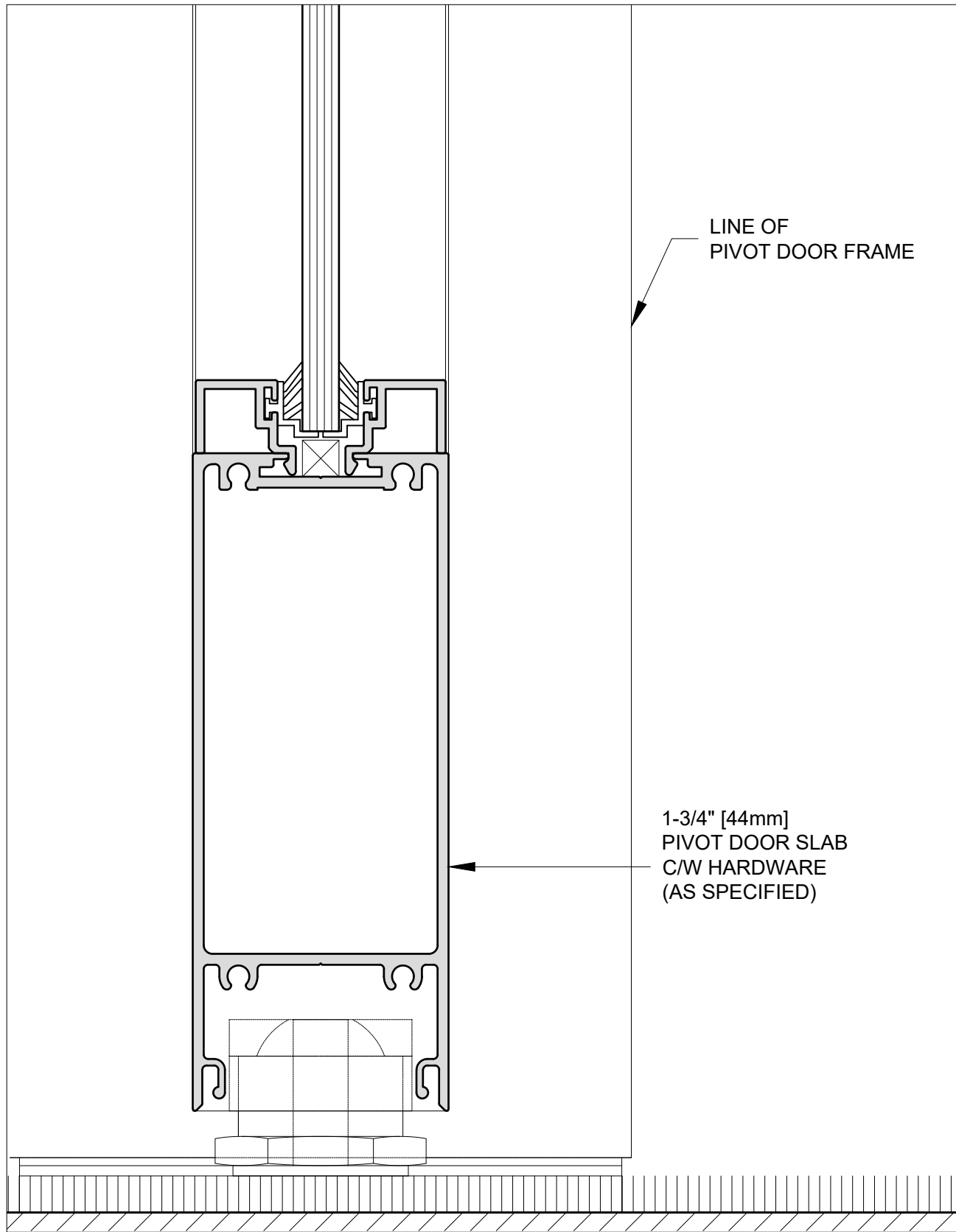

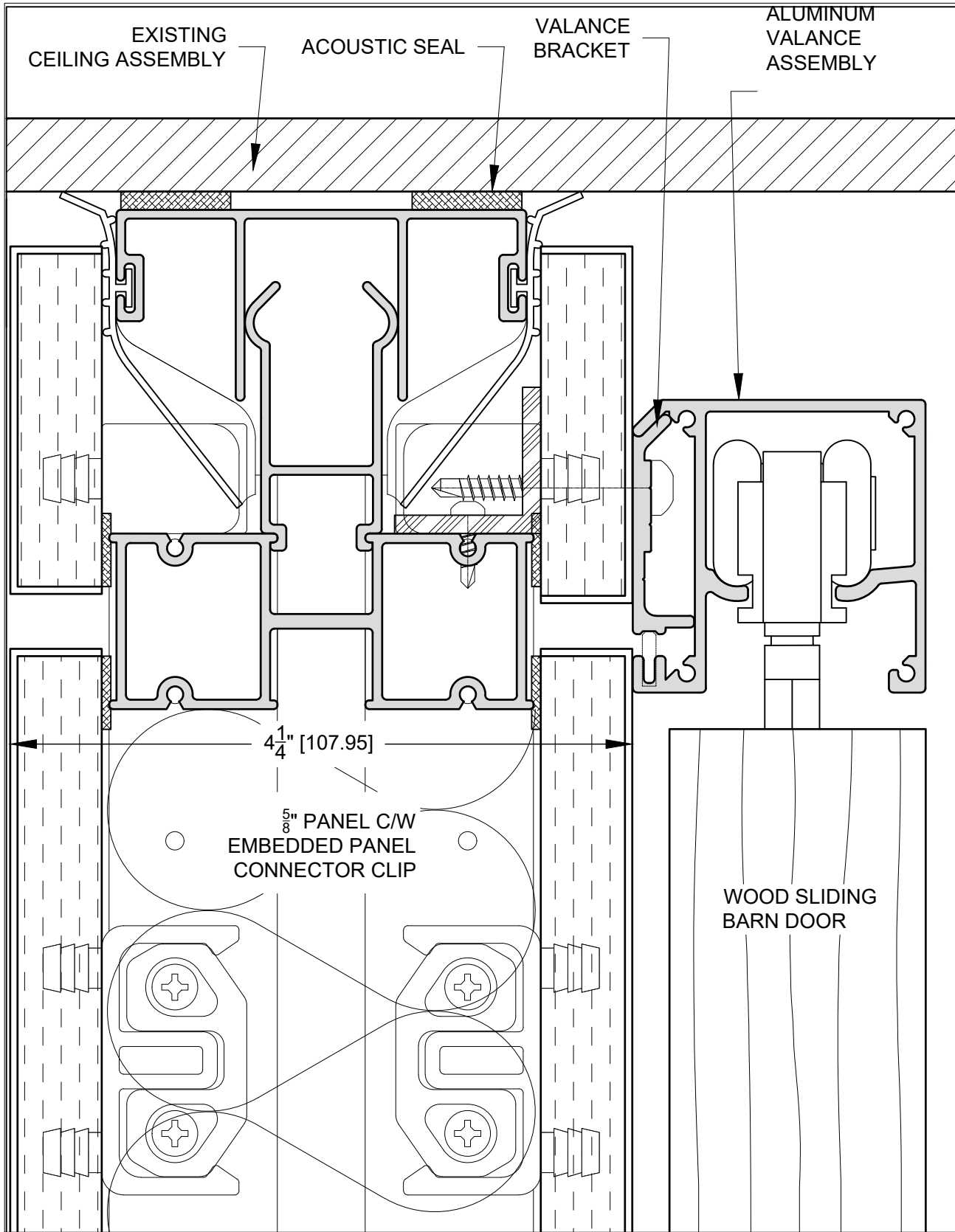

**WOODEN SLIDING DOOR  
CEILING ASM**

DWG:  
**1.2.1.2**

FILE:

SCALE: 1 : 1

DATE: OCT 2020

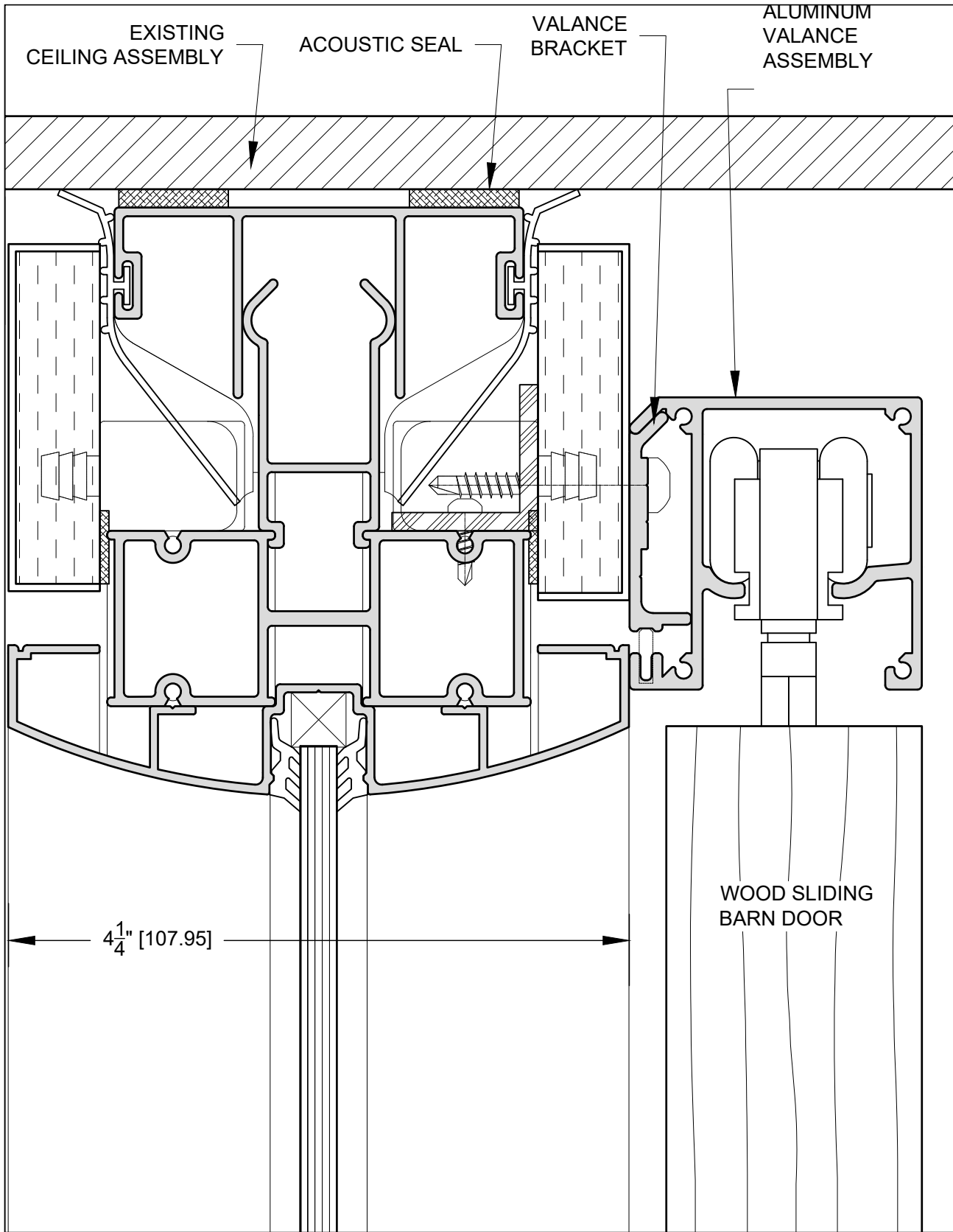

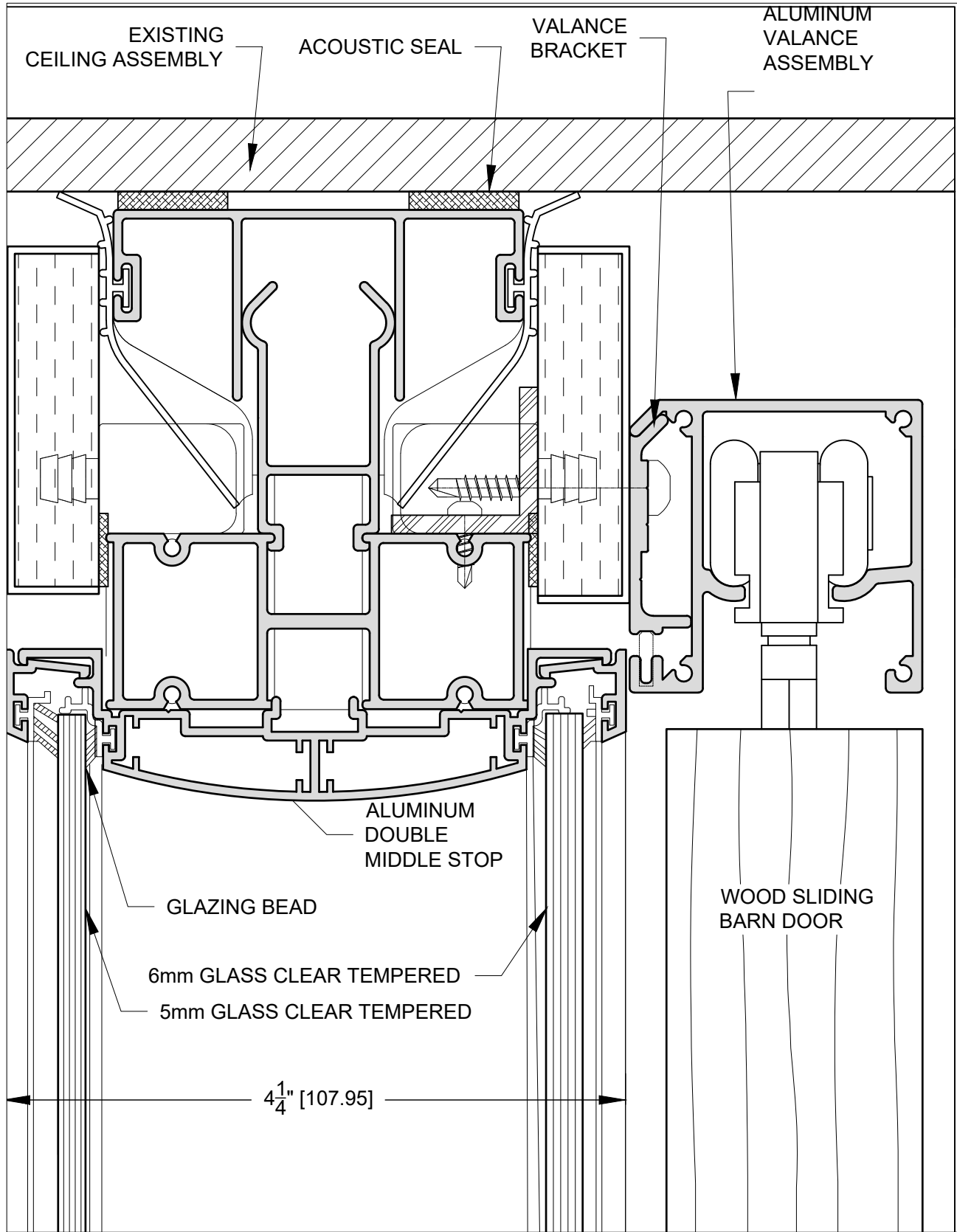

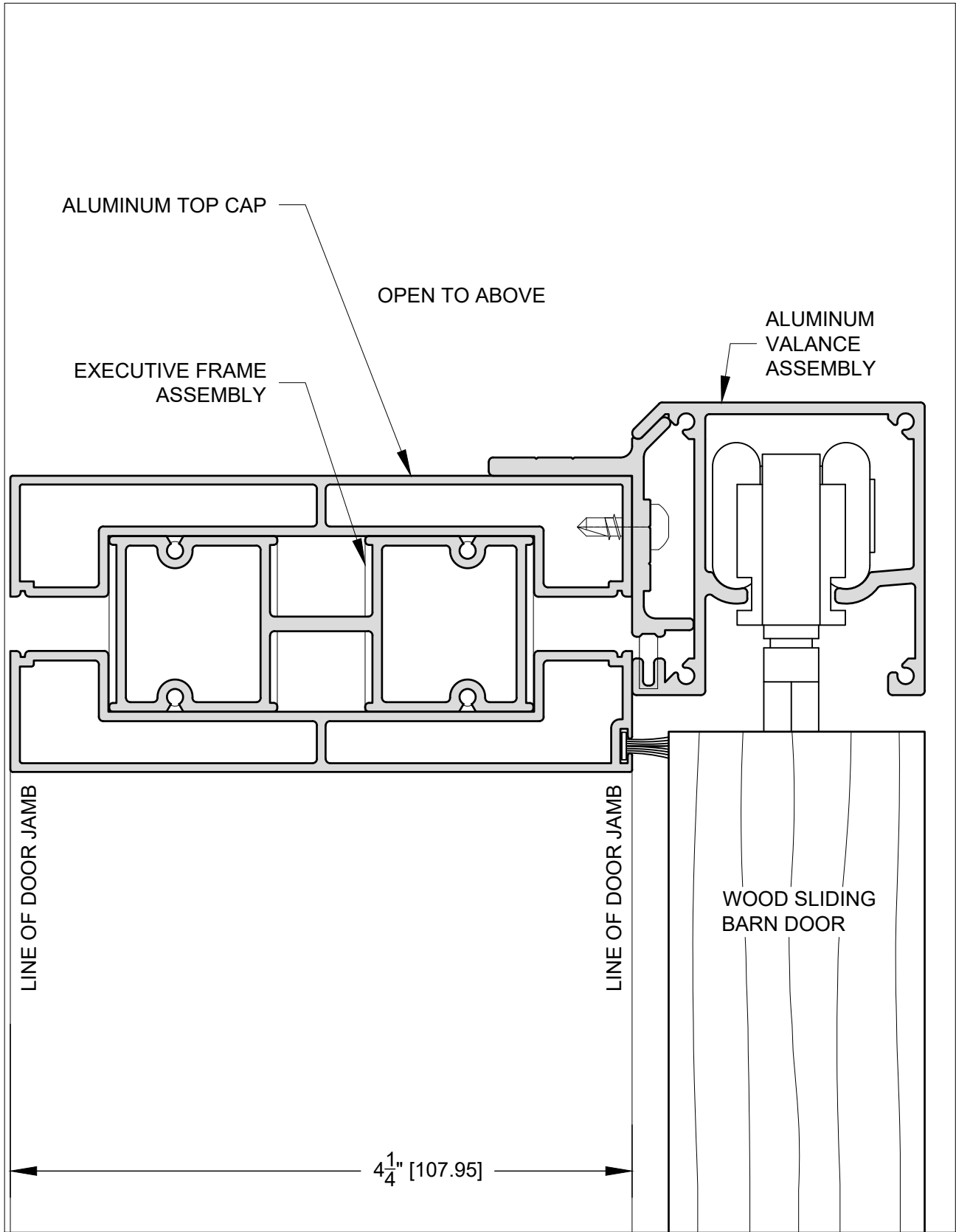

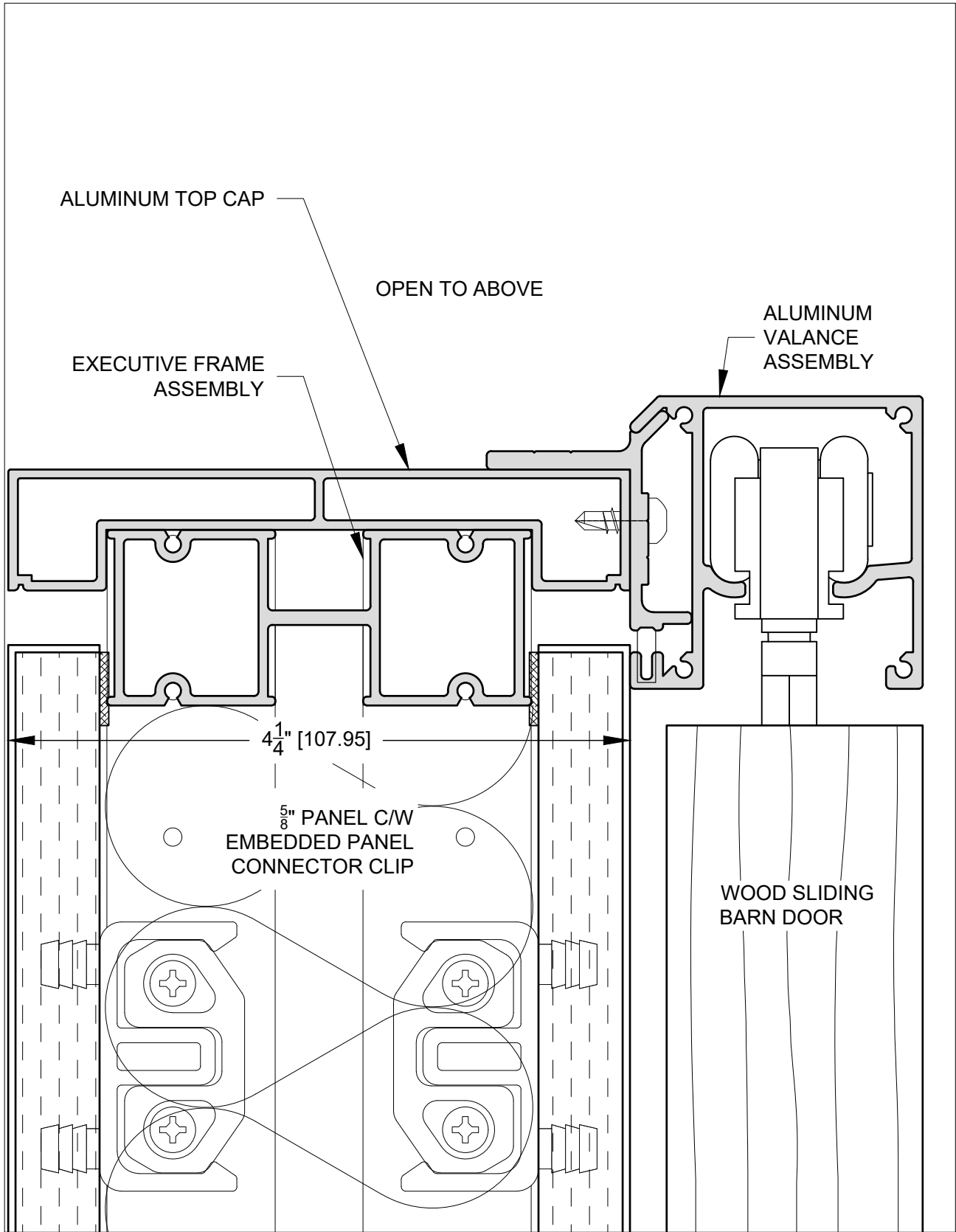



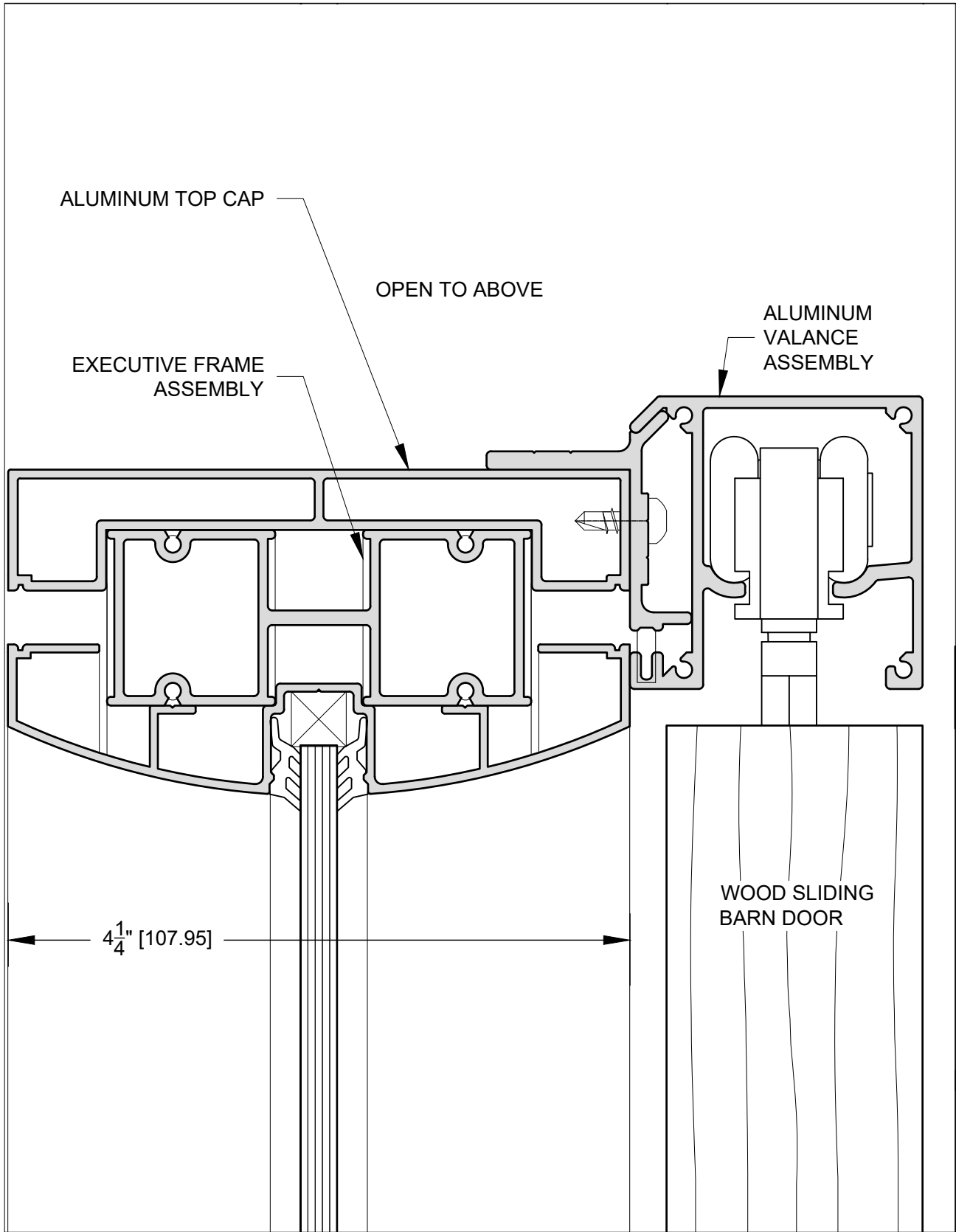

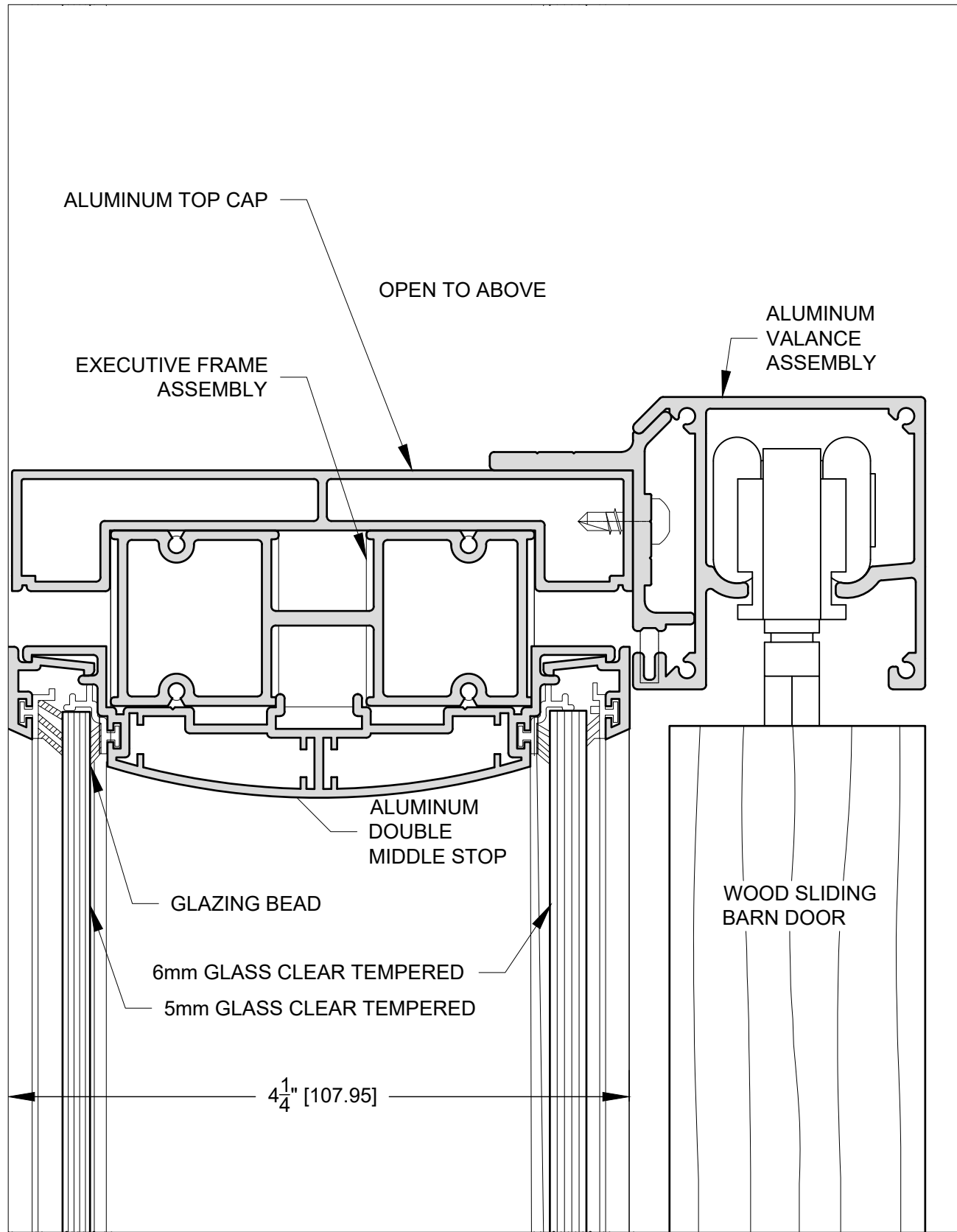

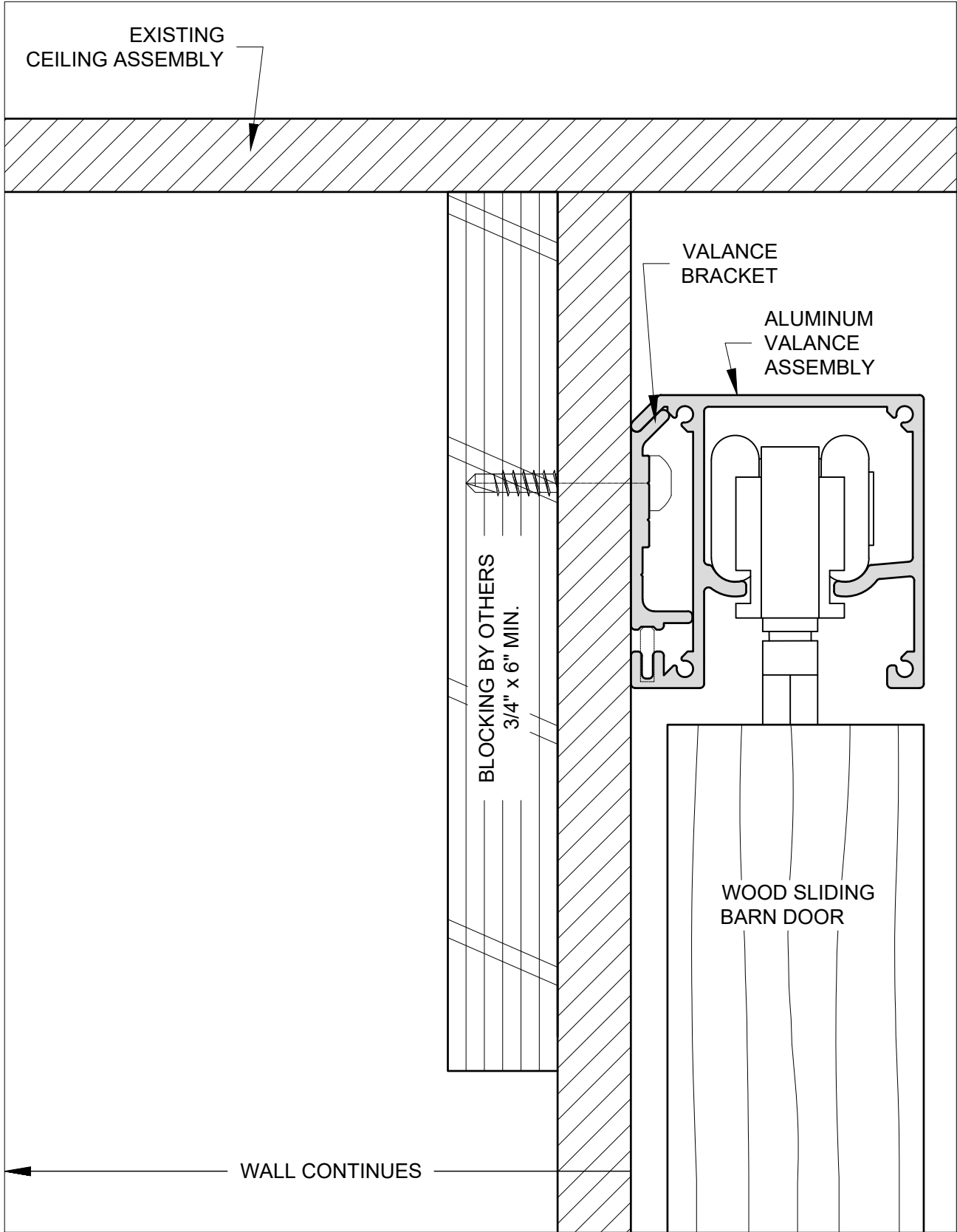

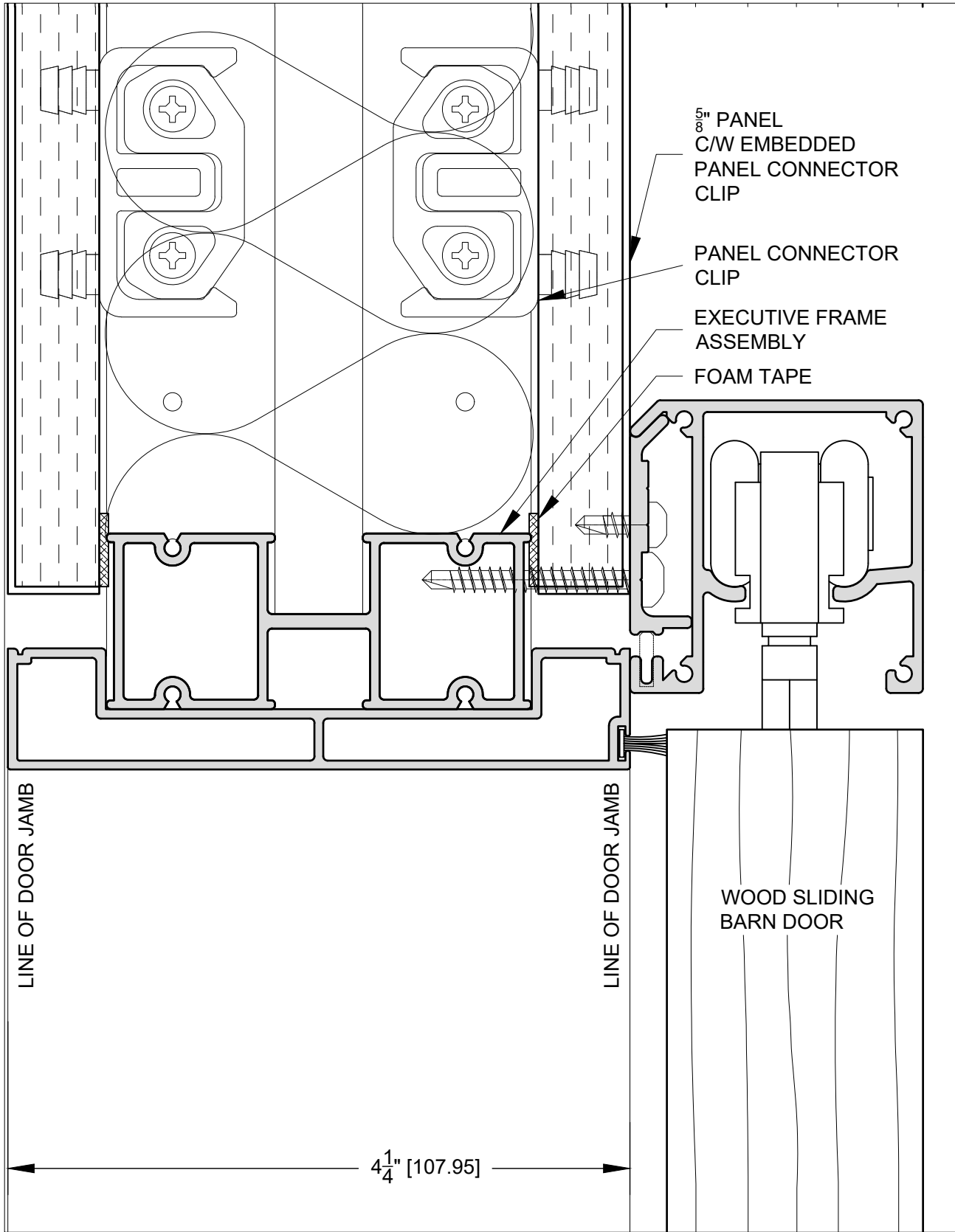

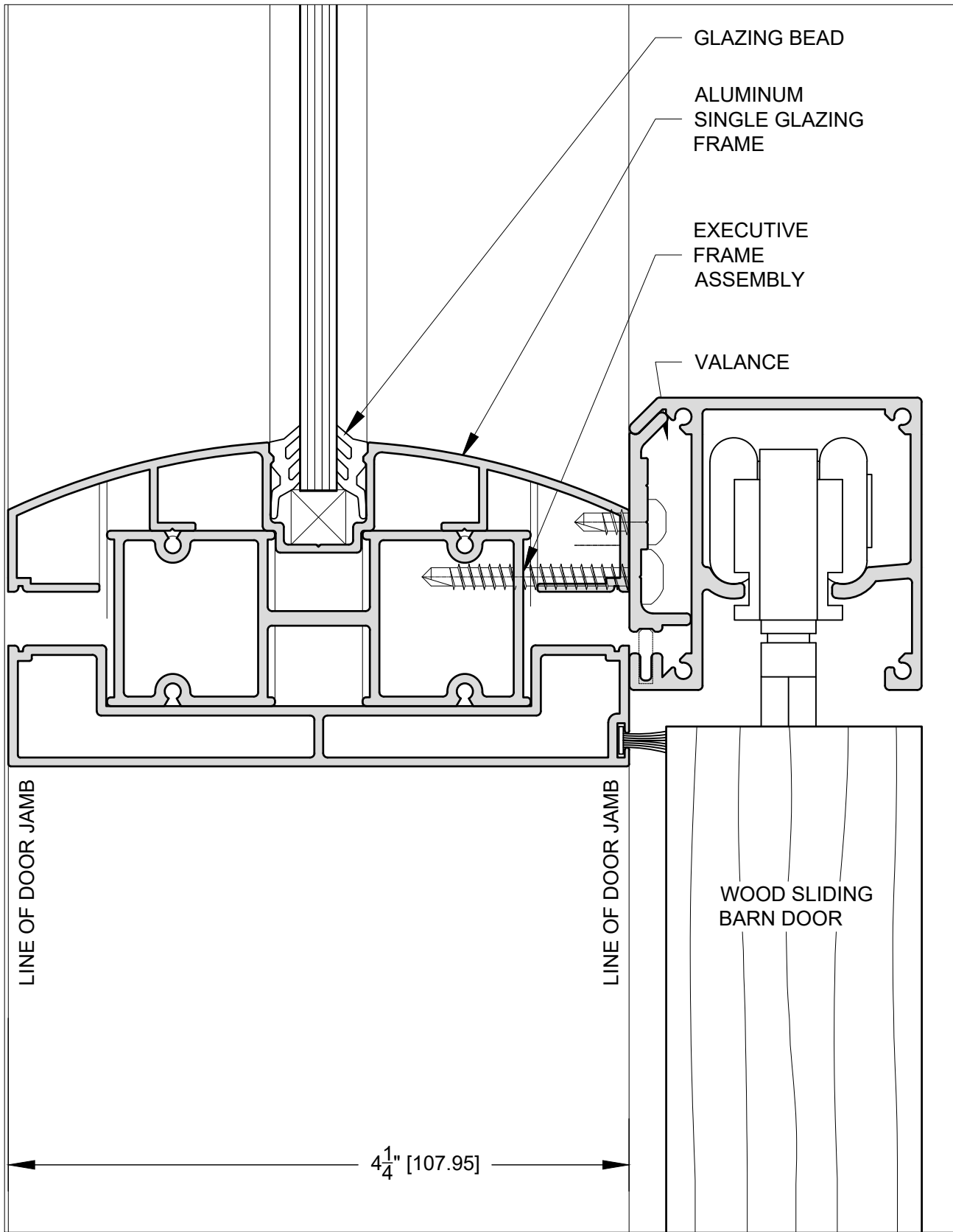

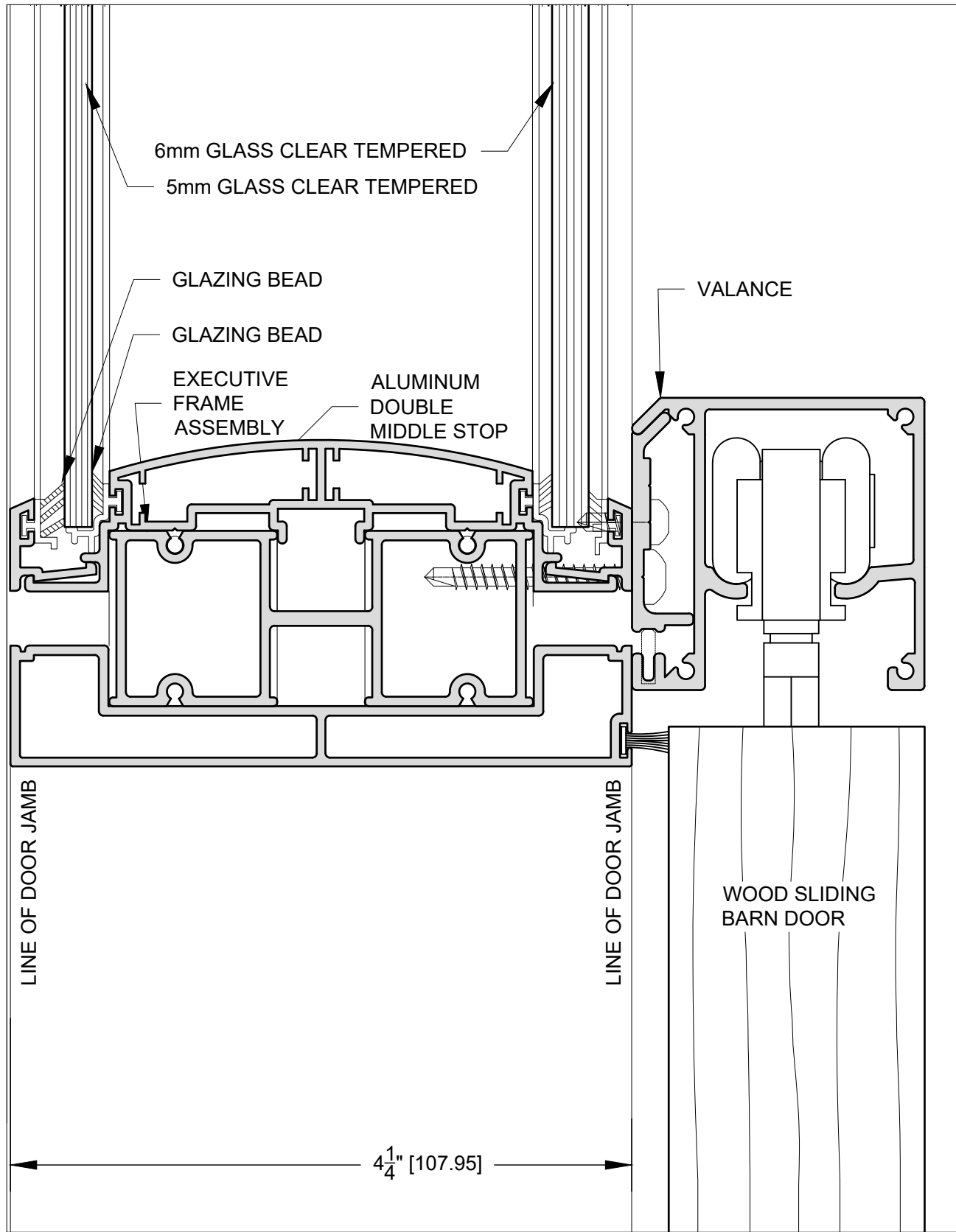

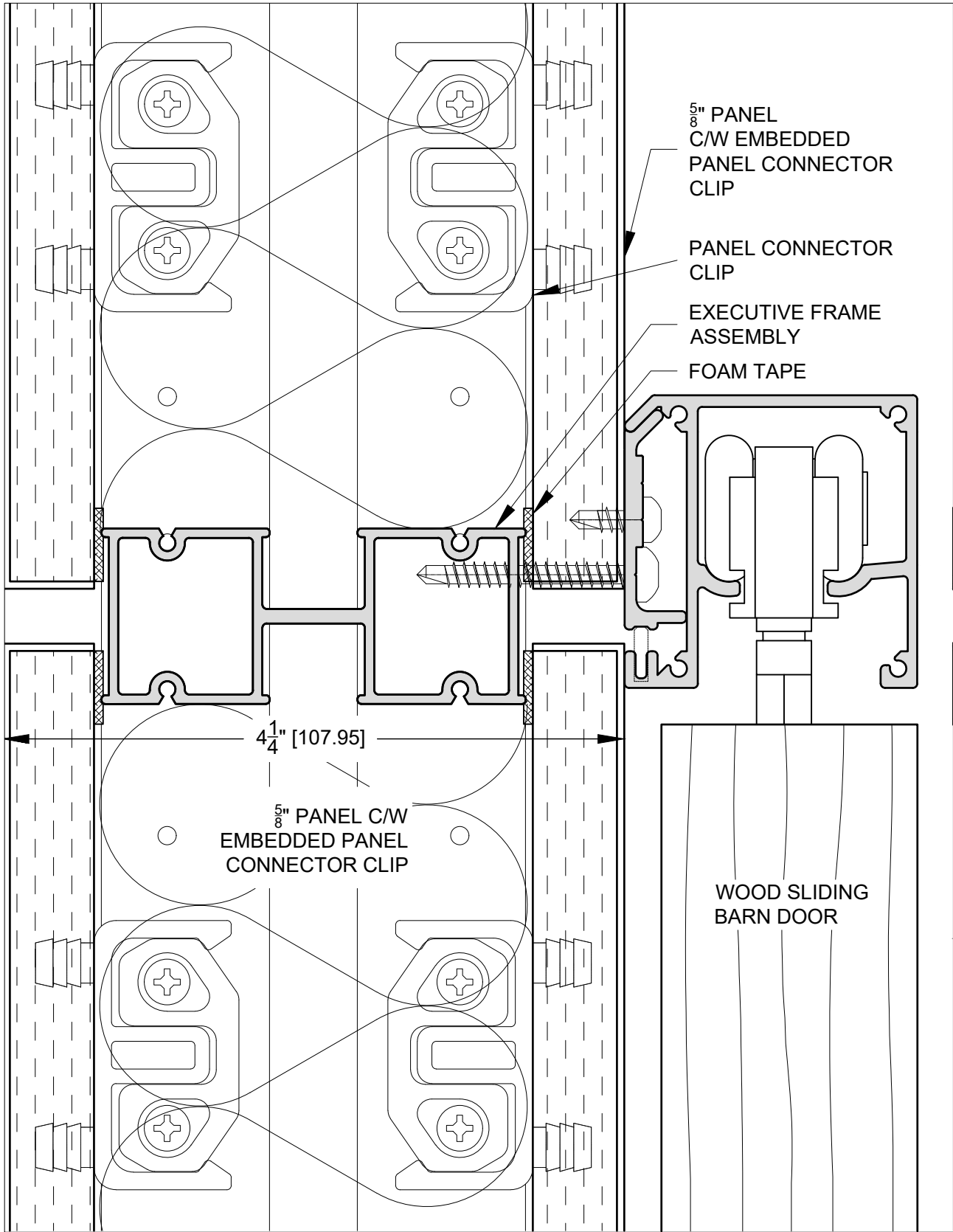

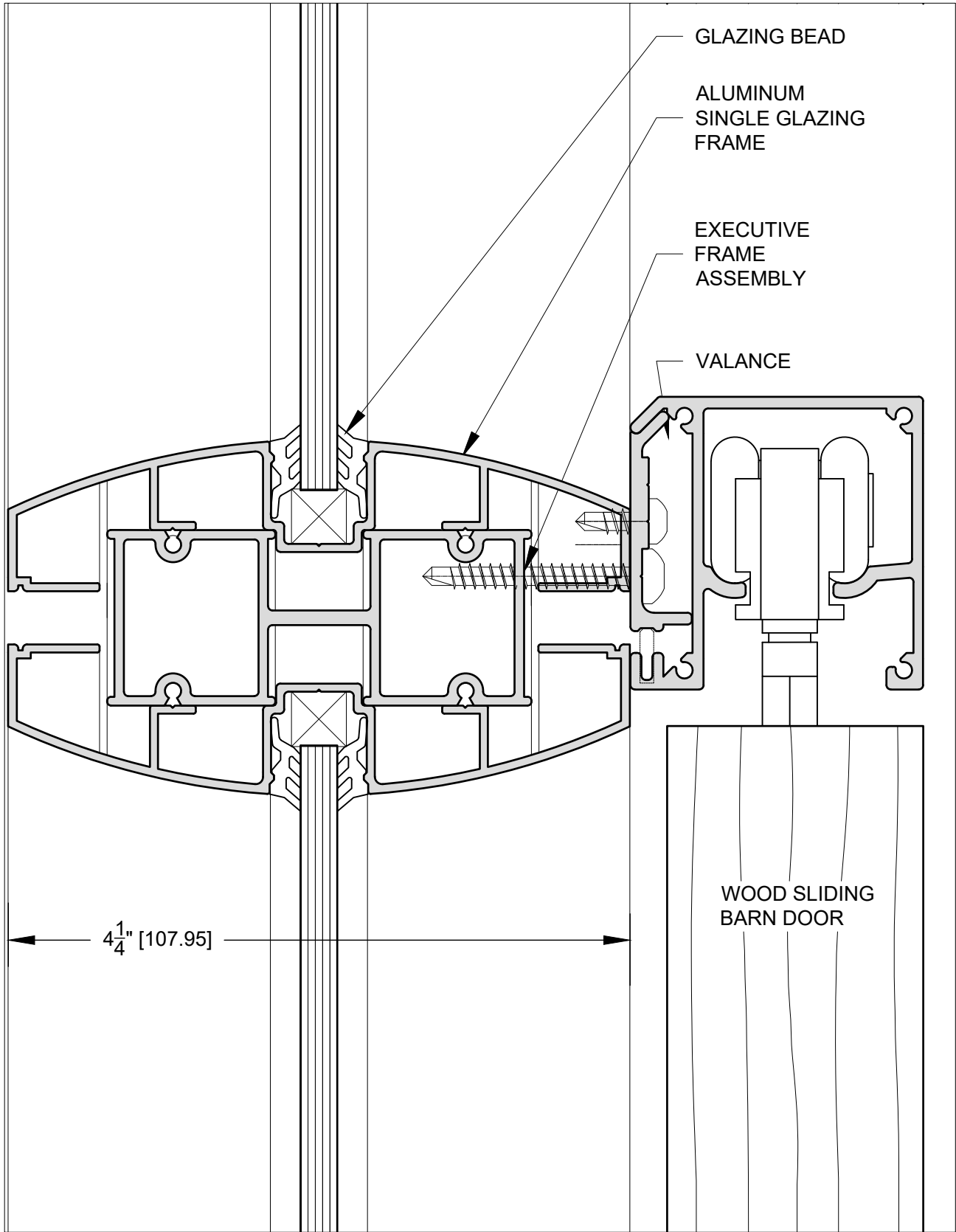



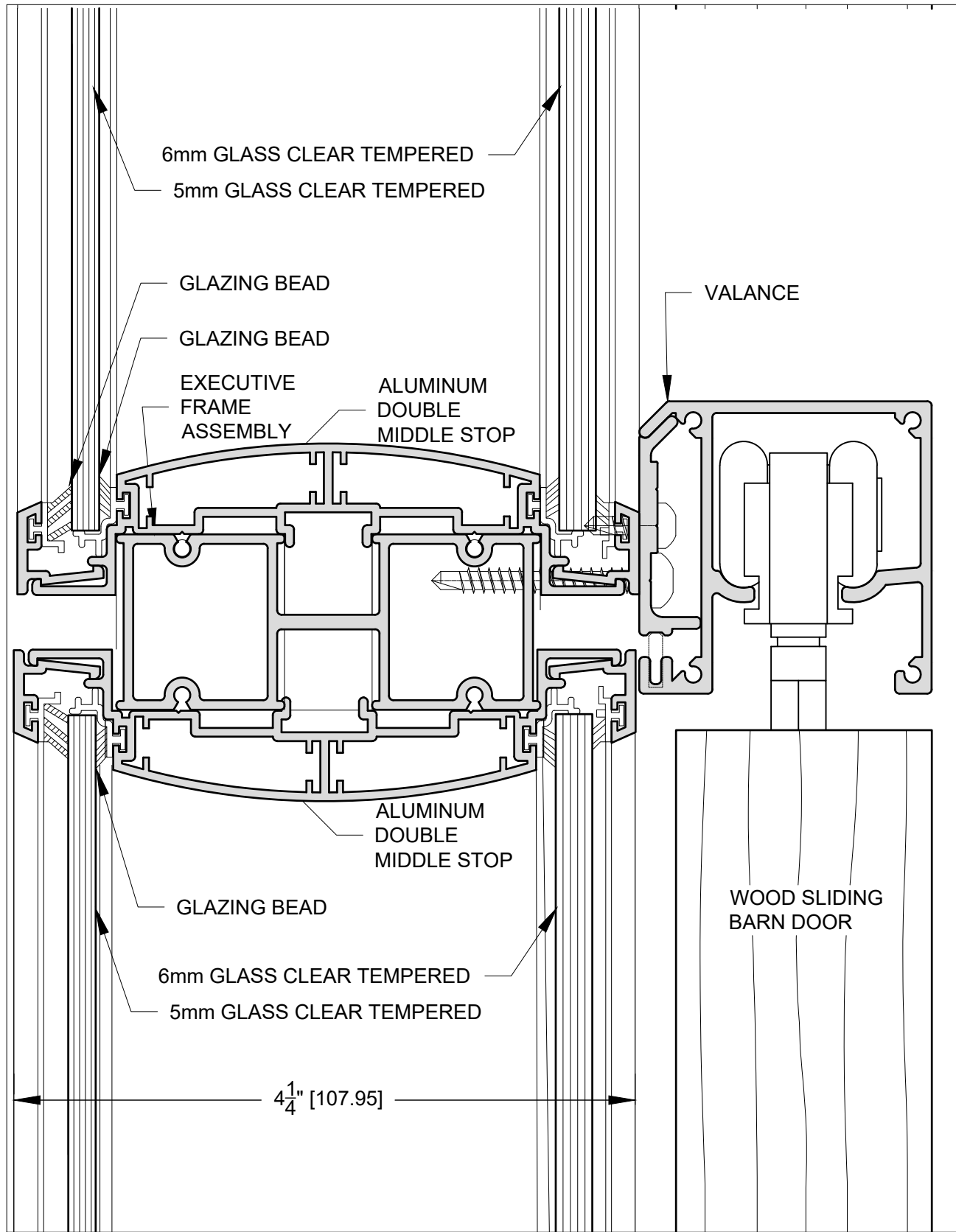

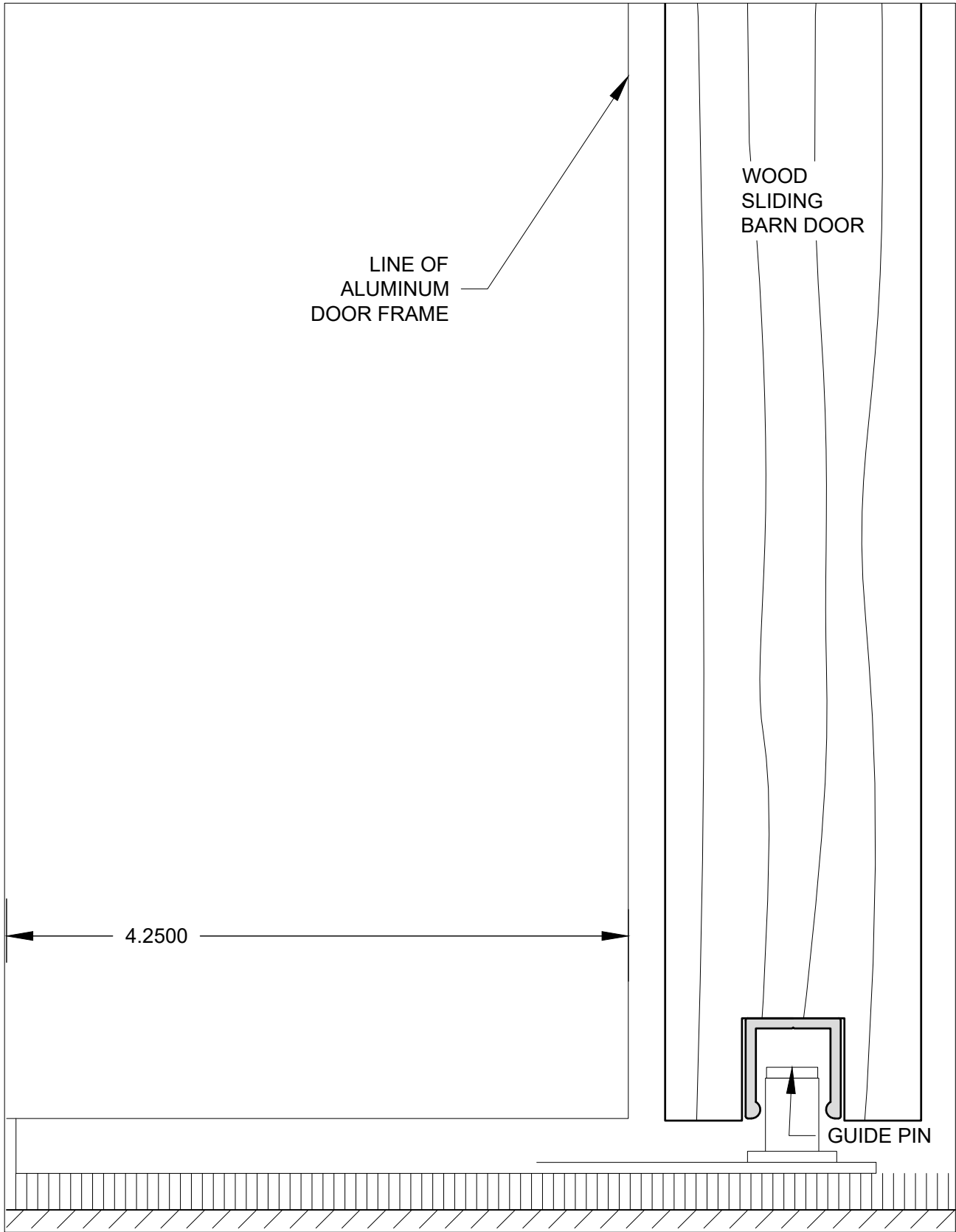

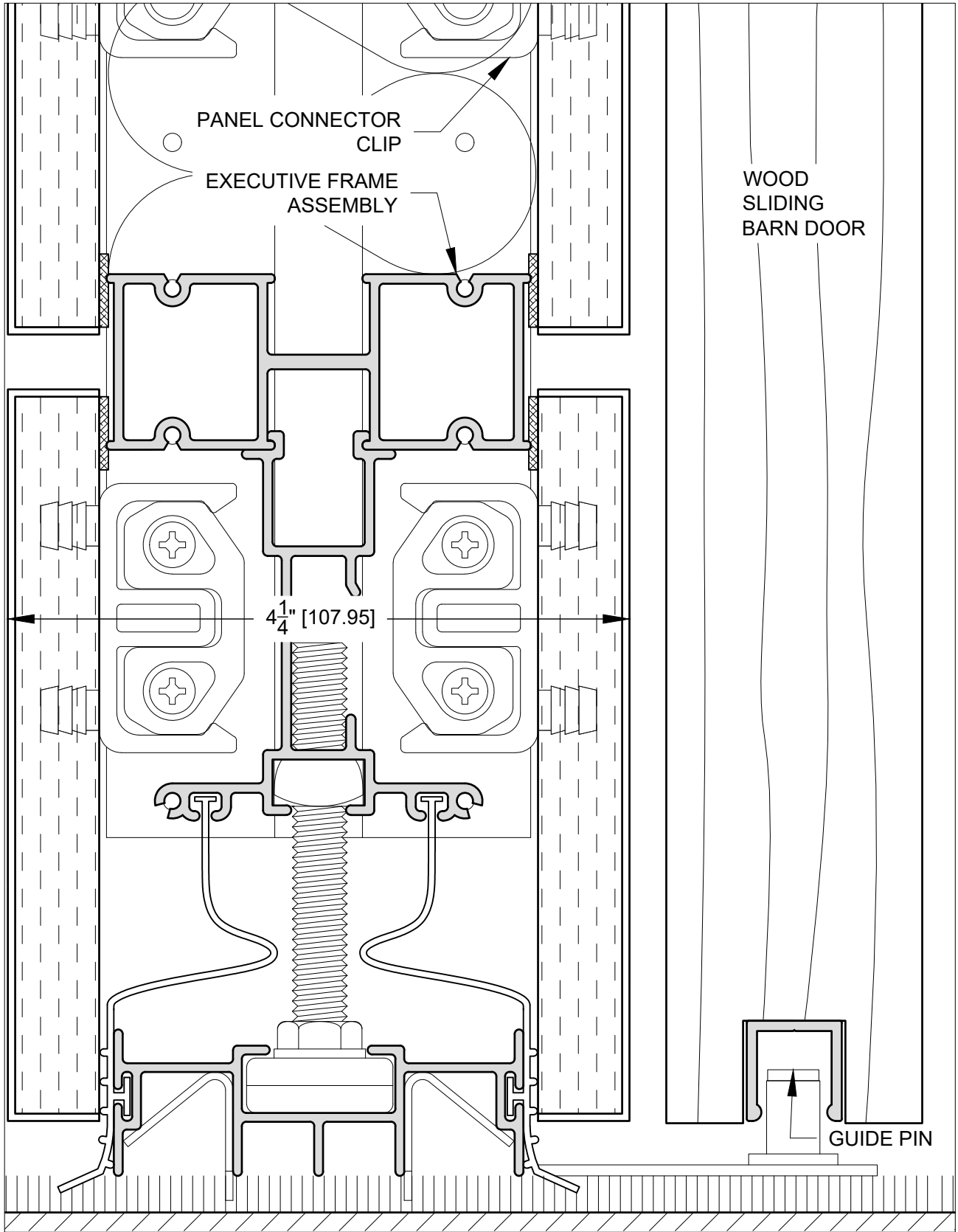

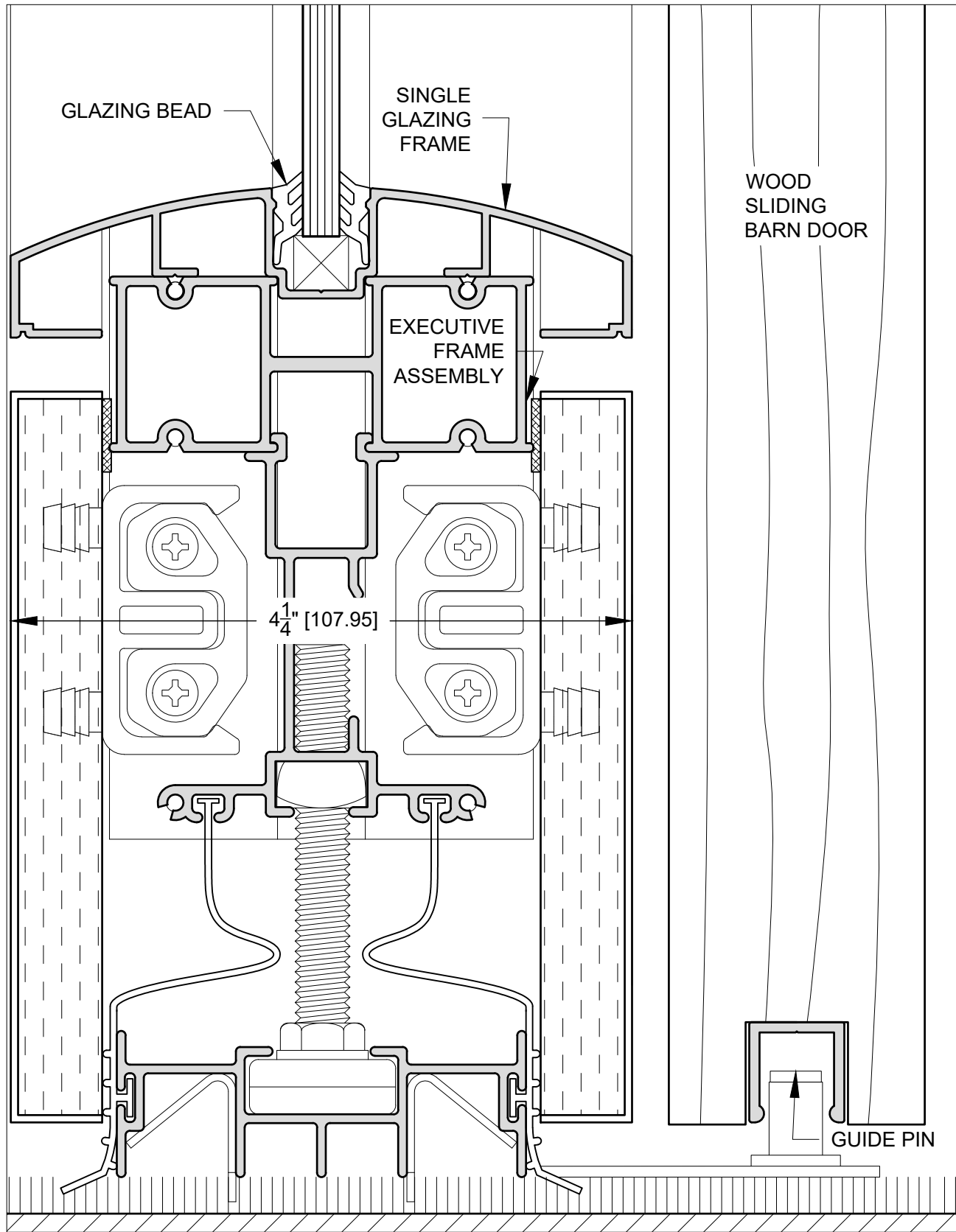

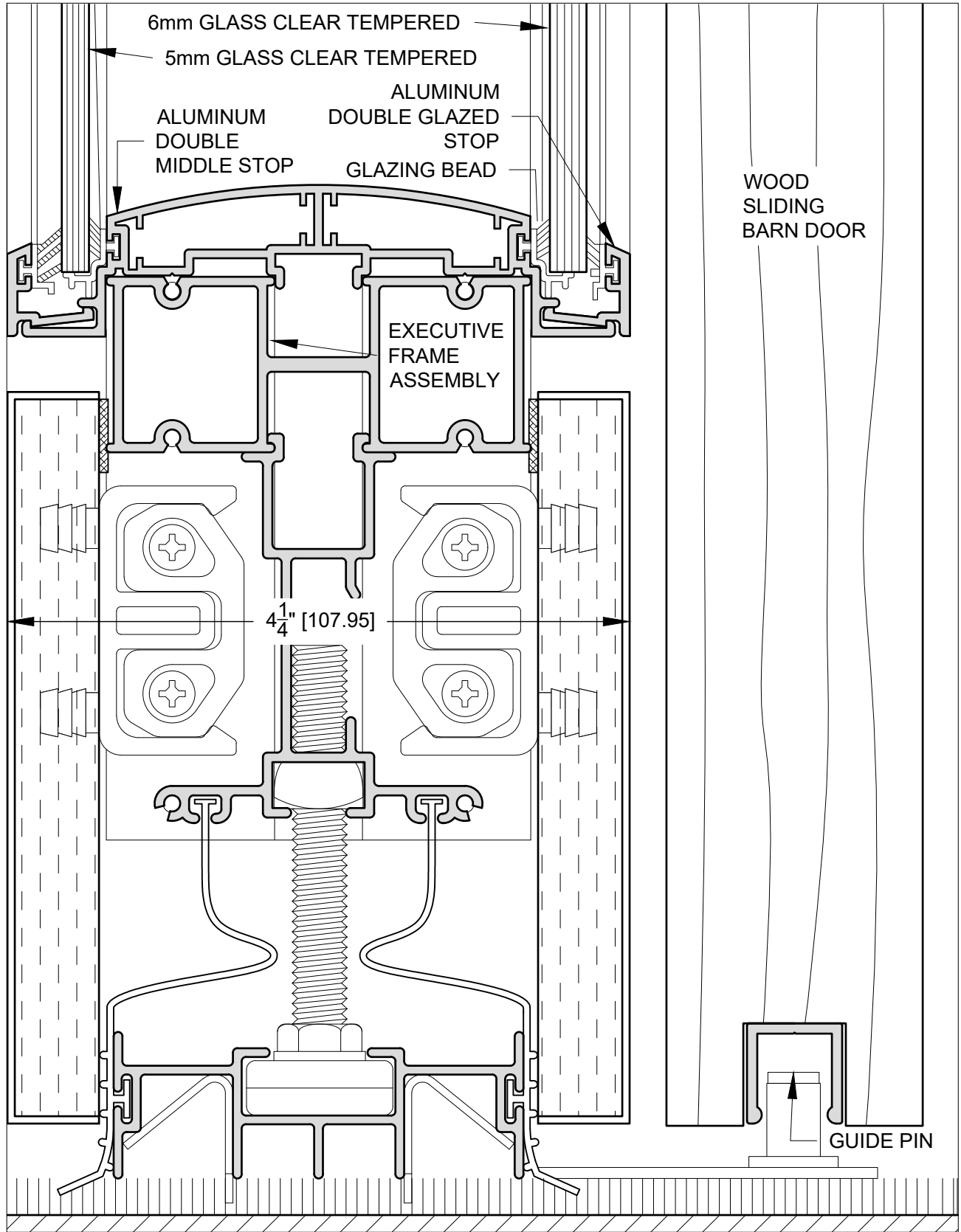

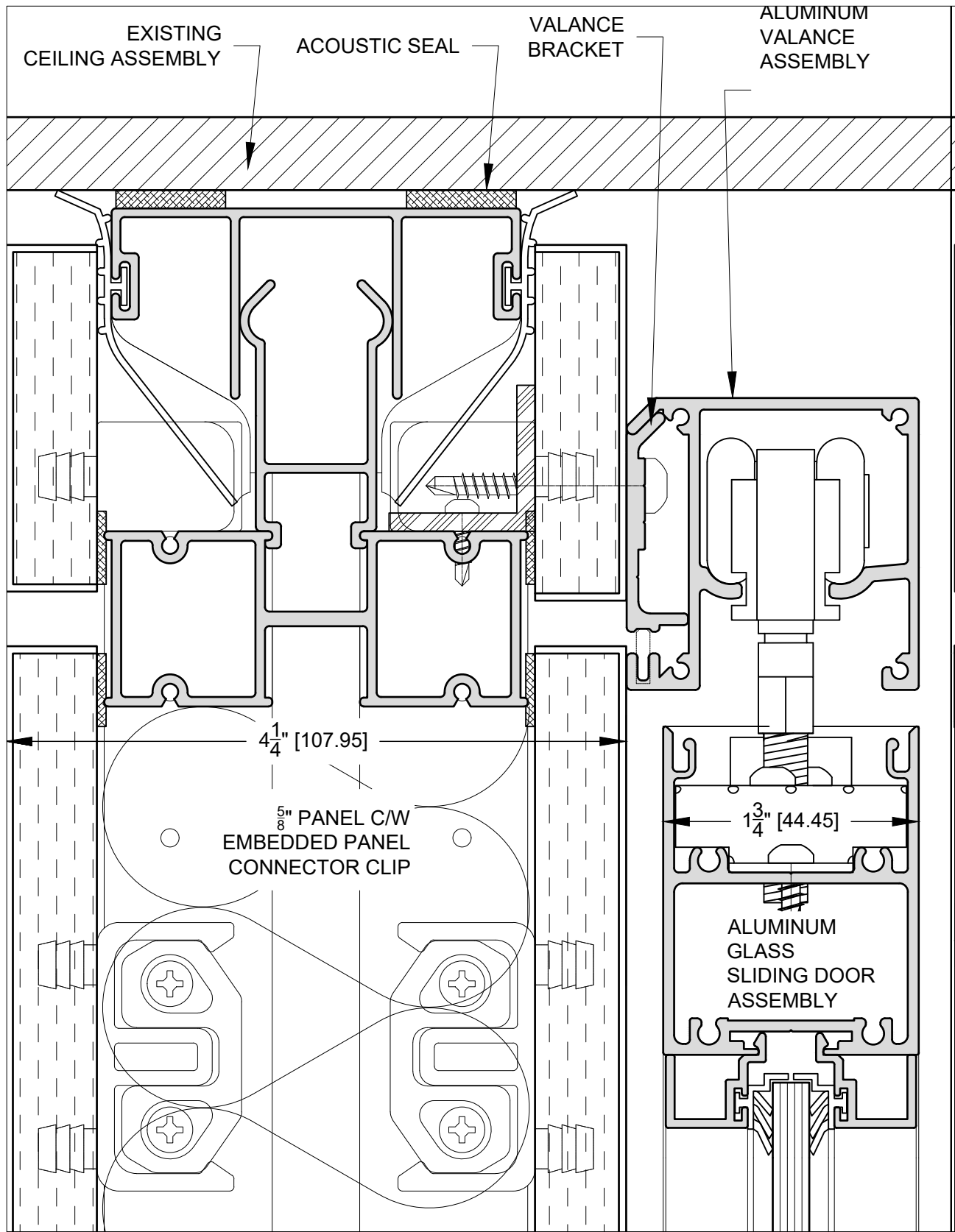

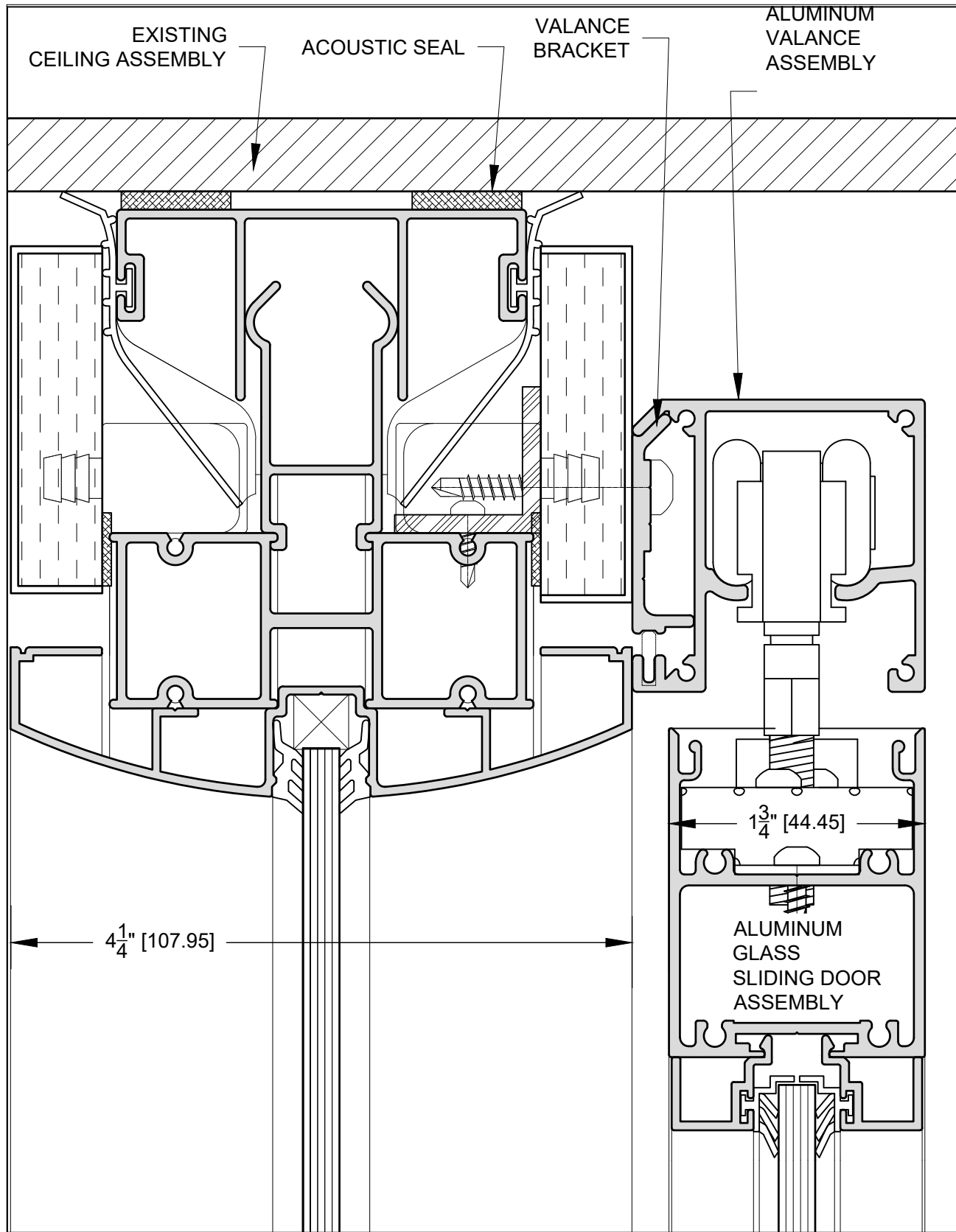

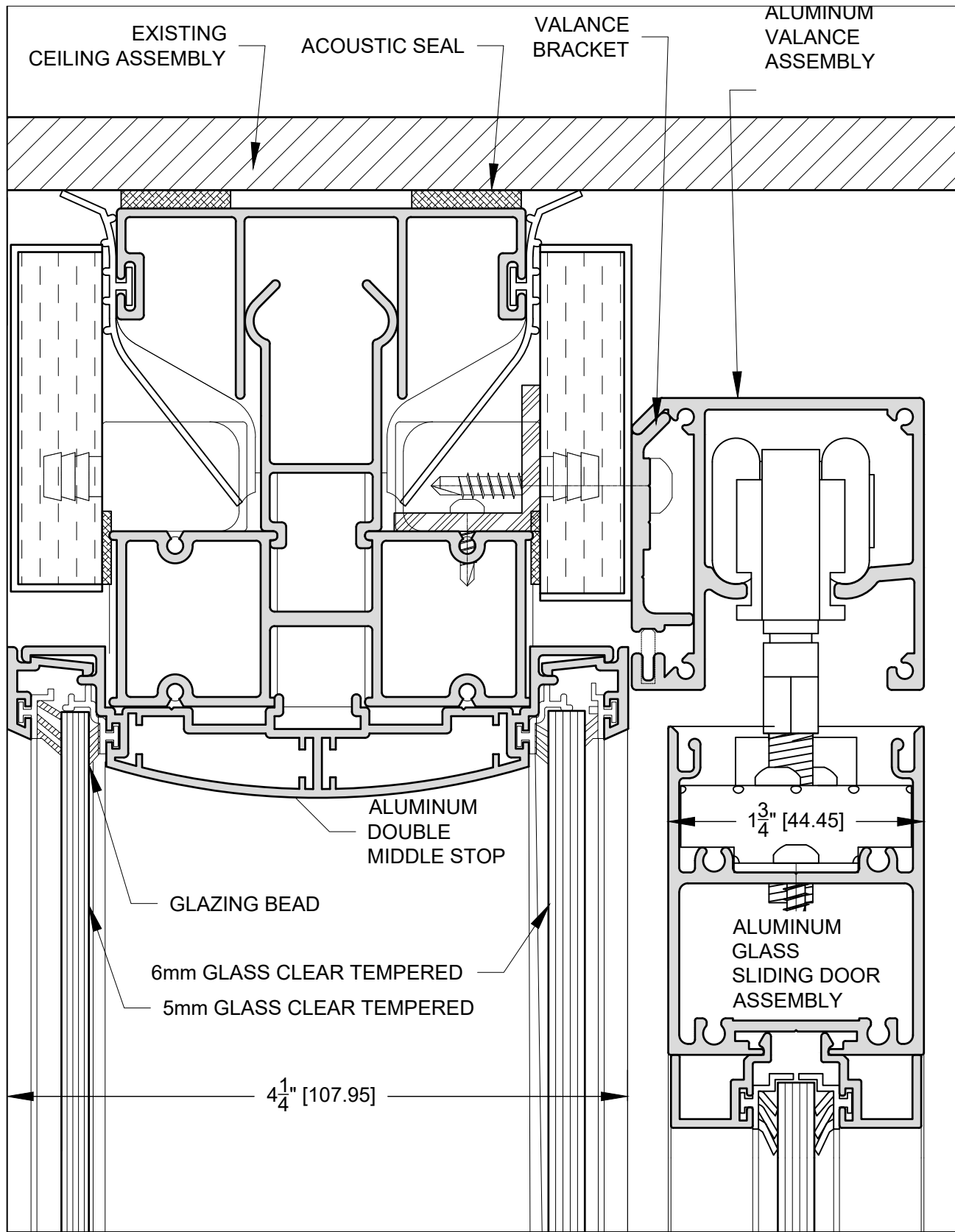



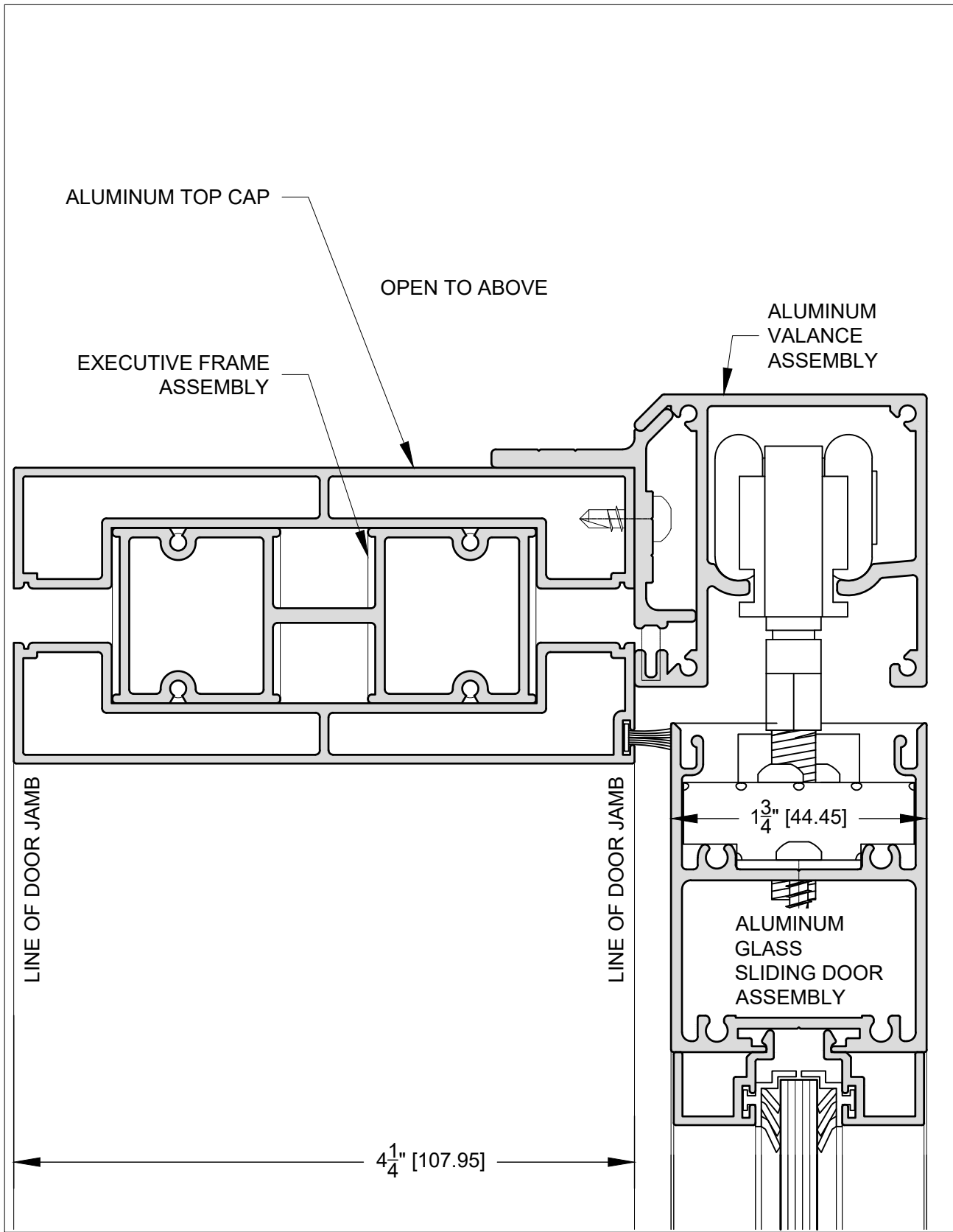

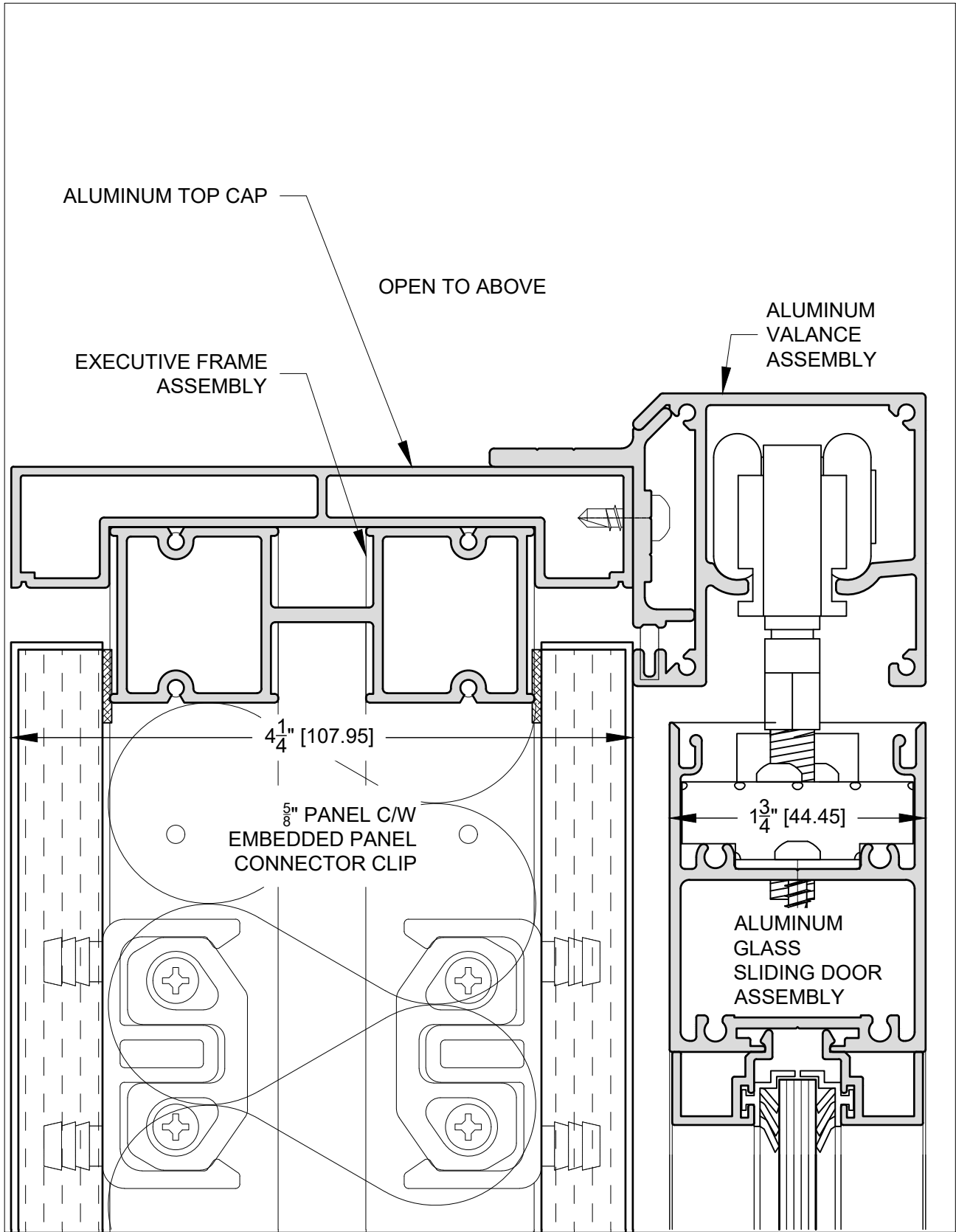

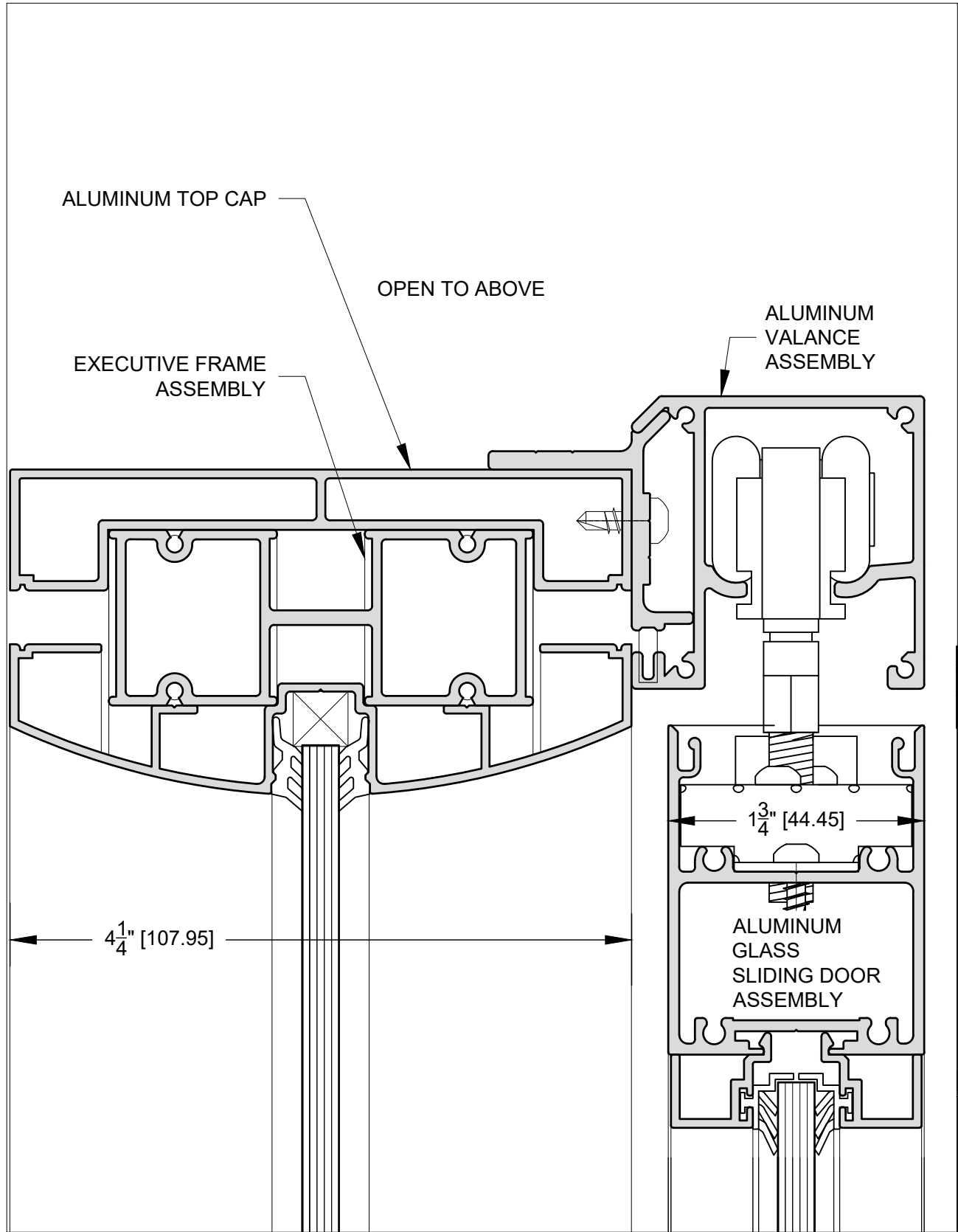

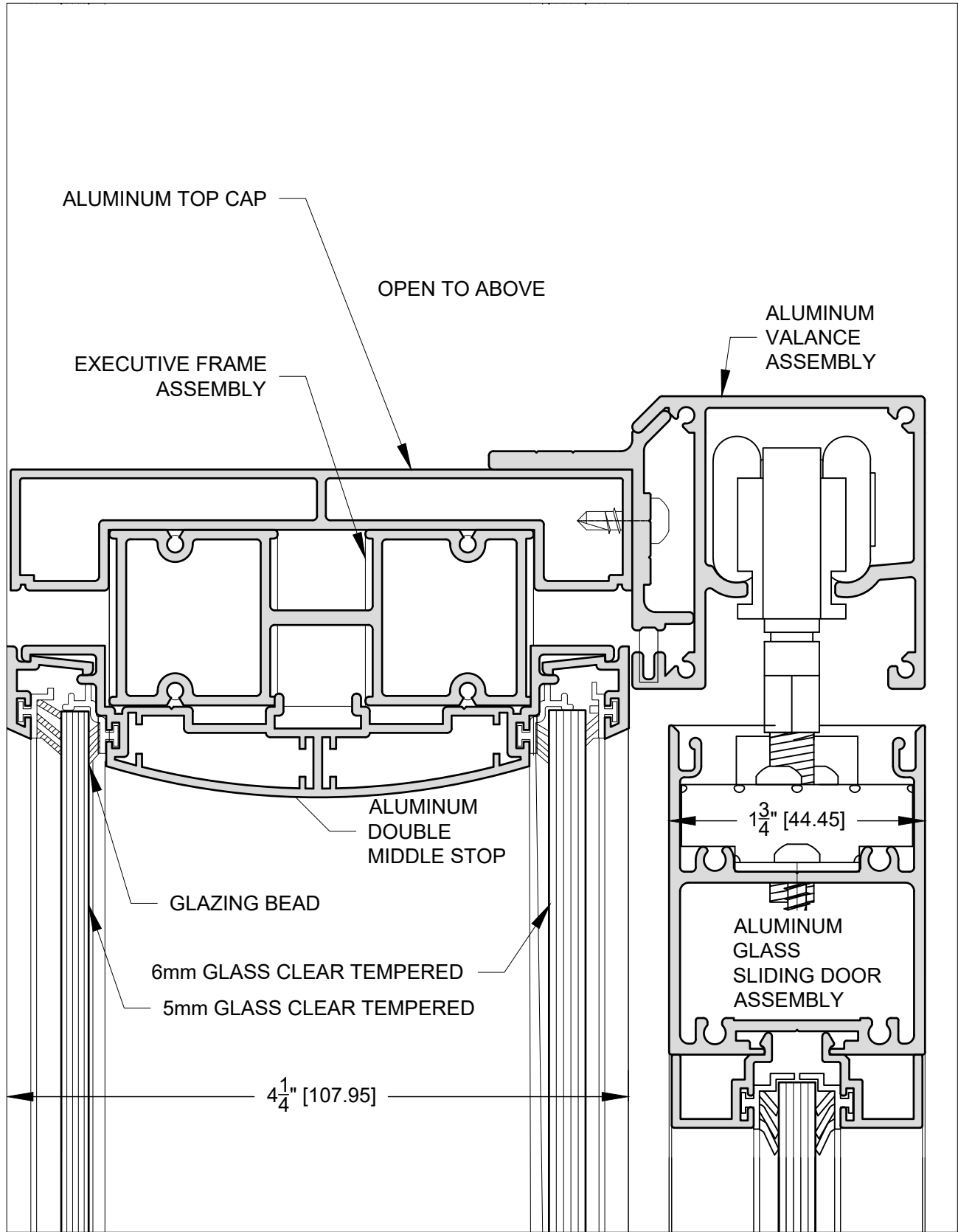

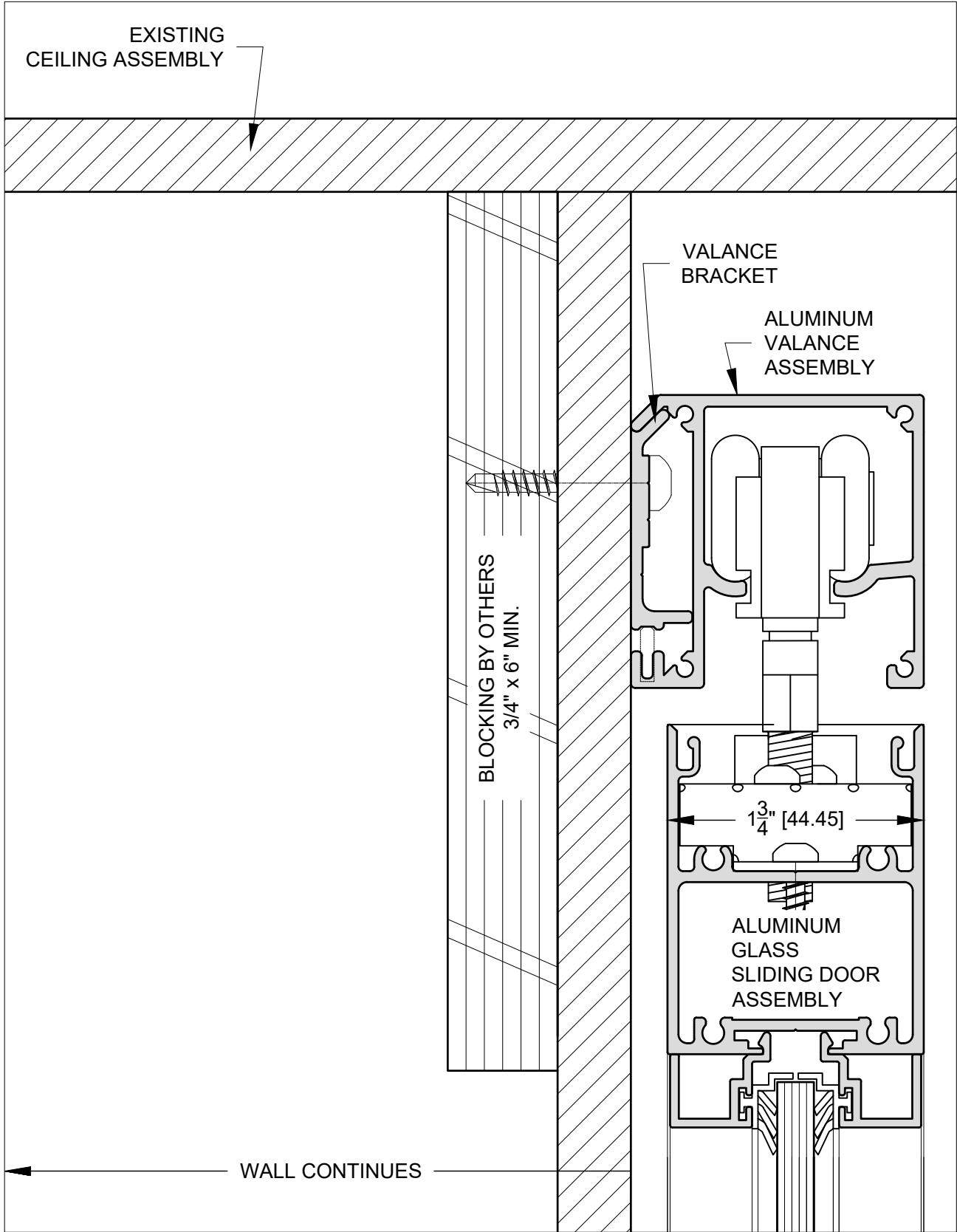

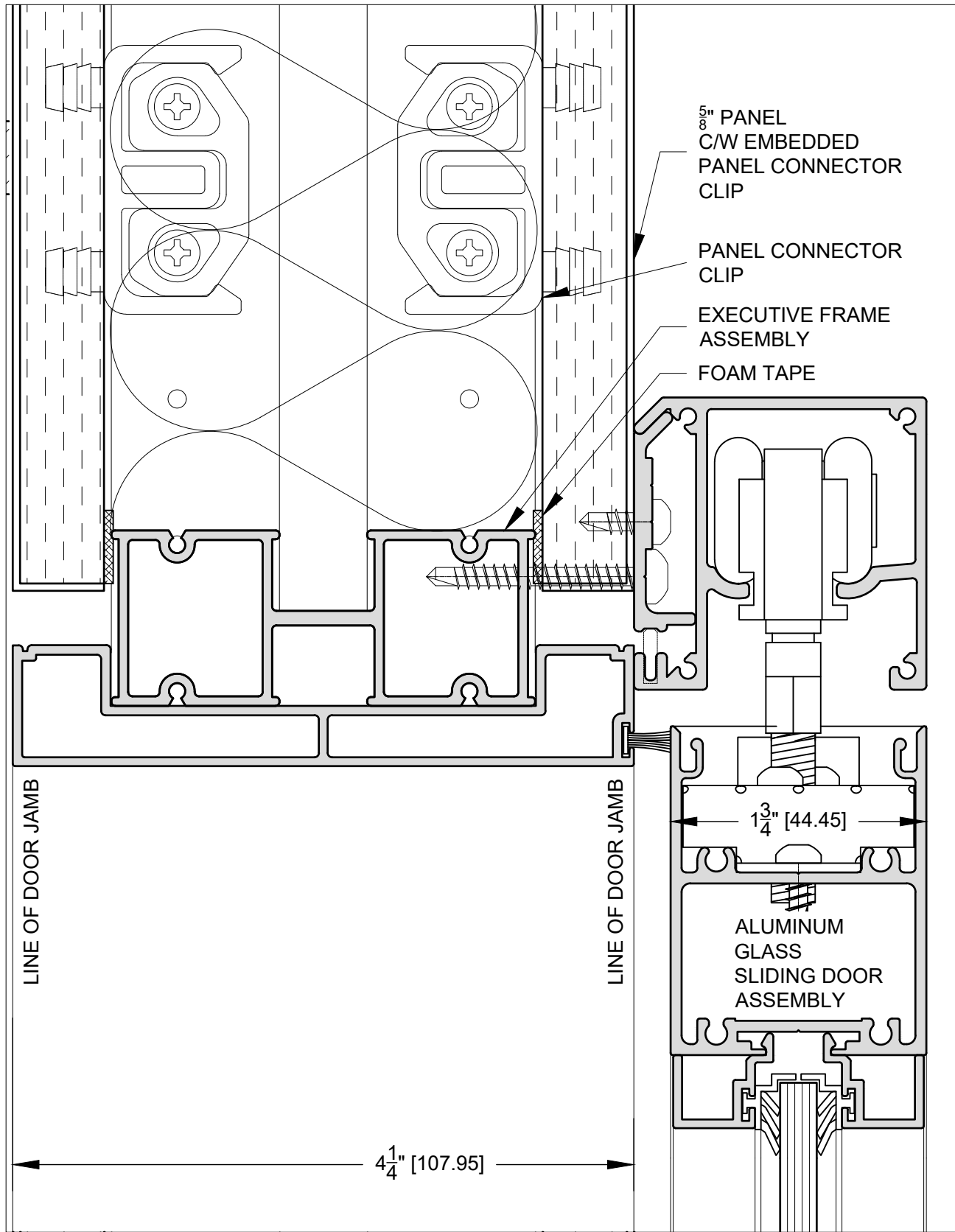

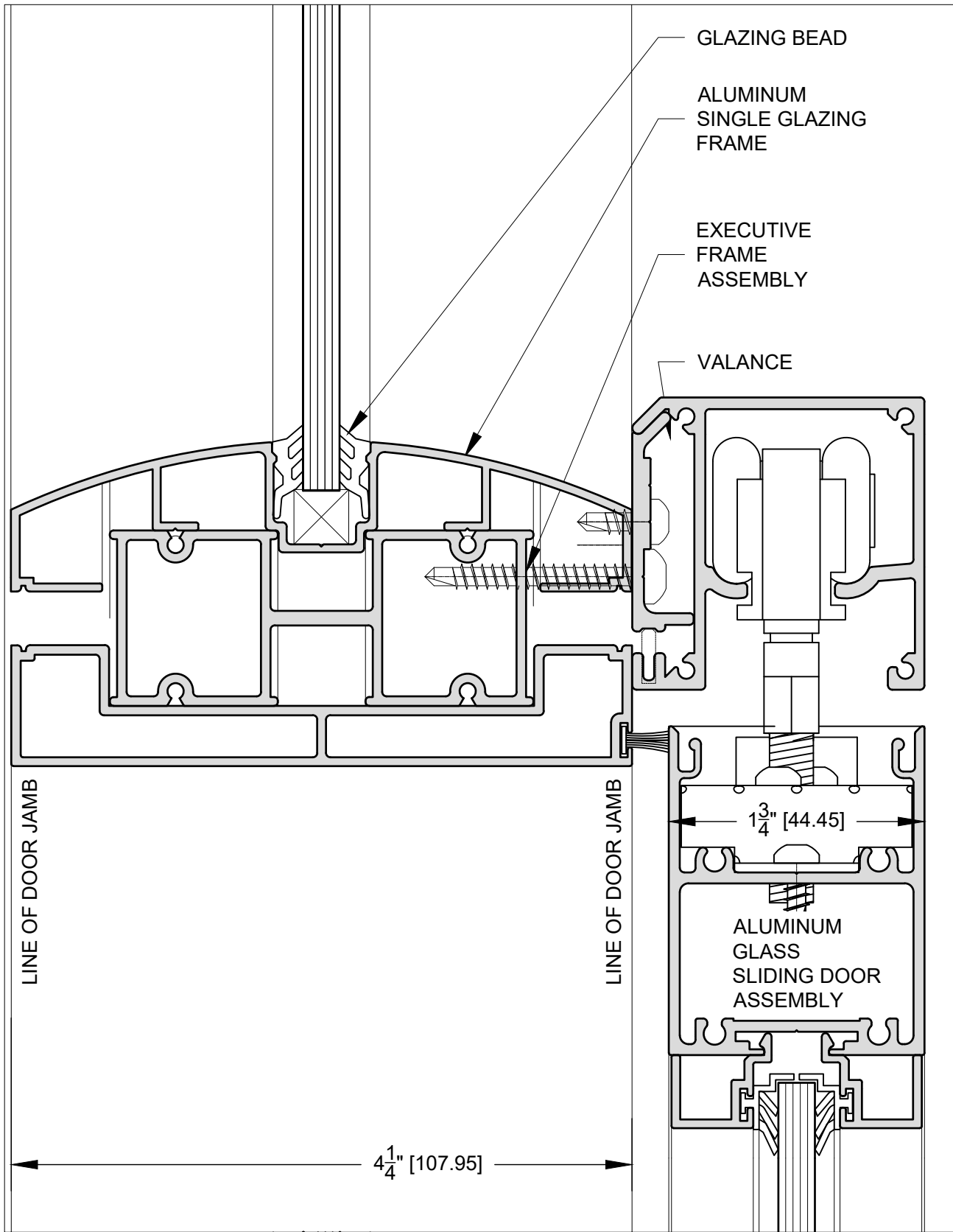

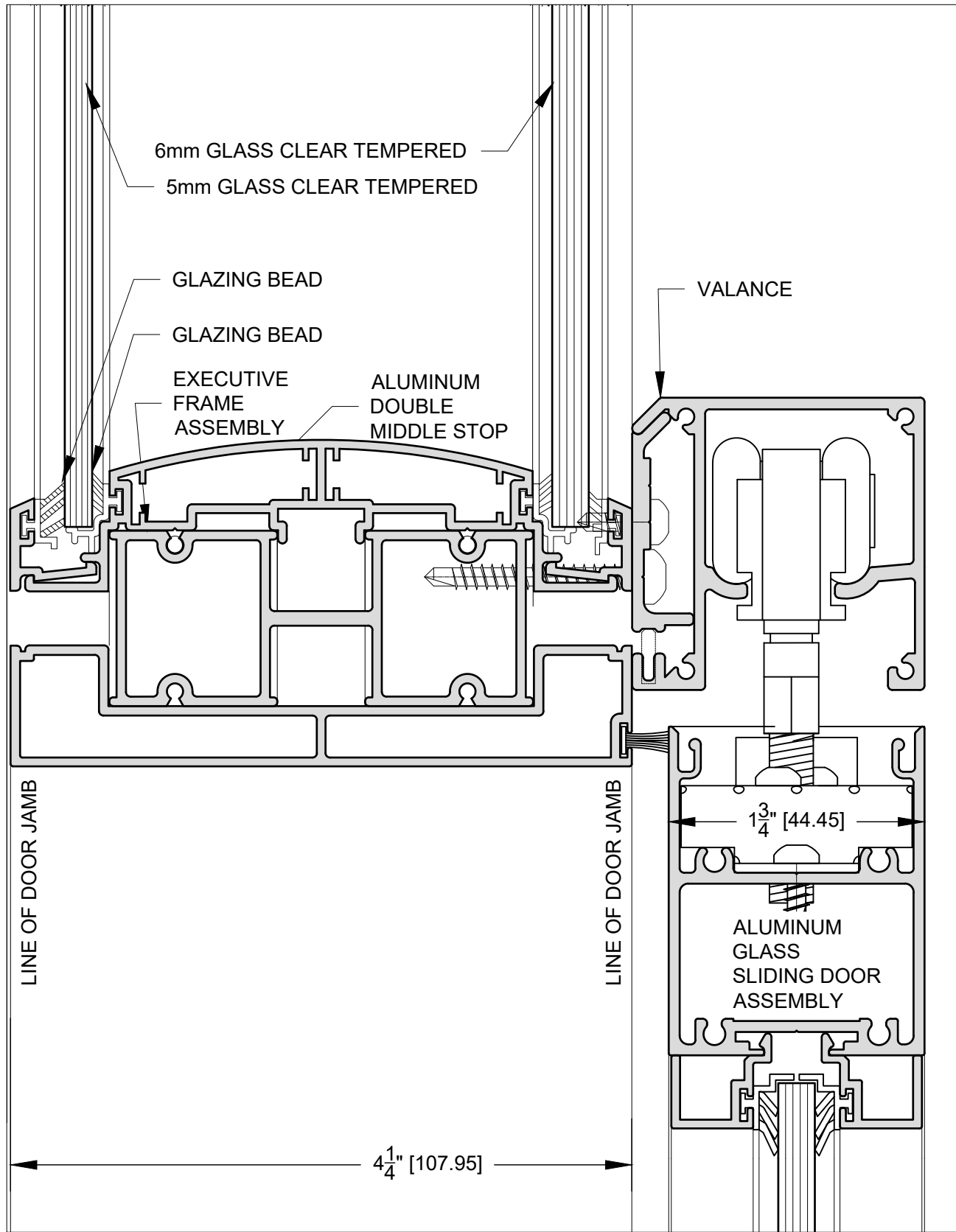



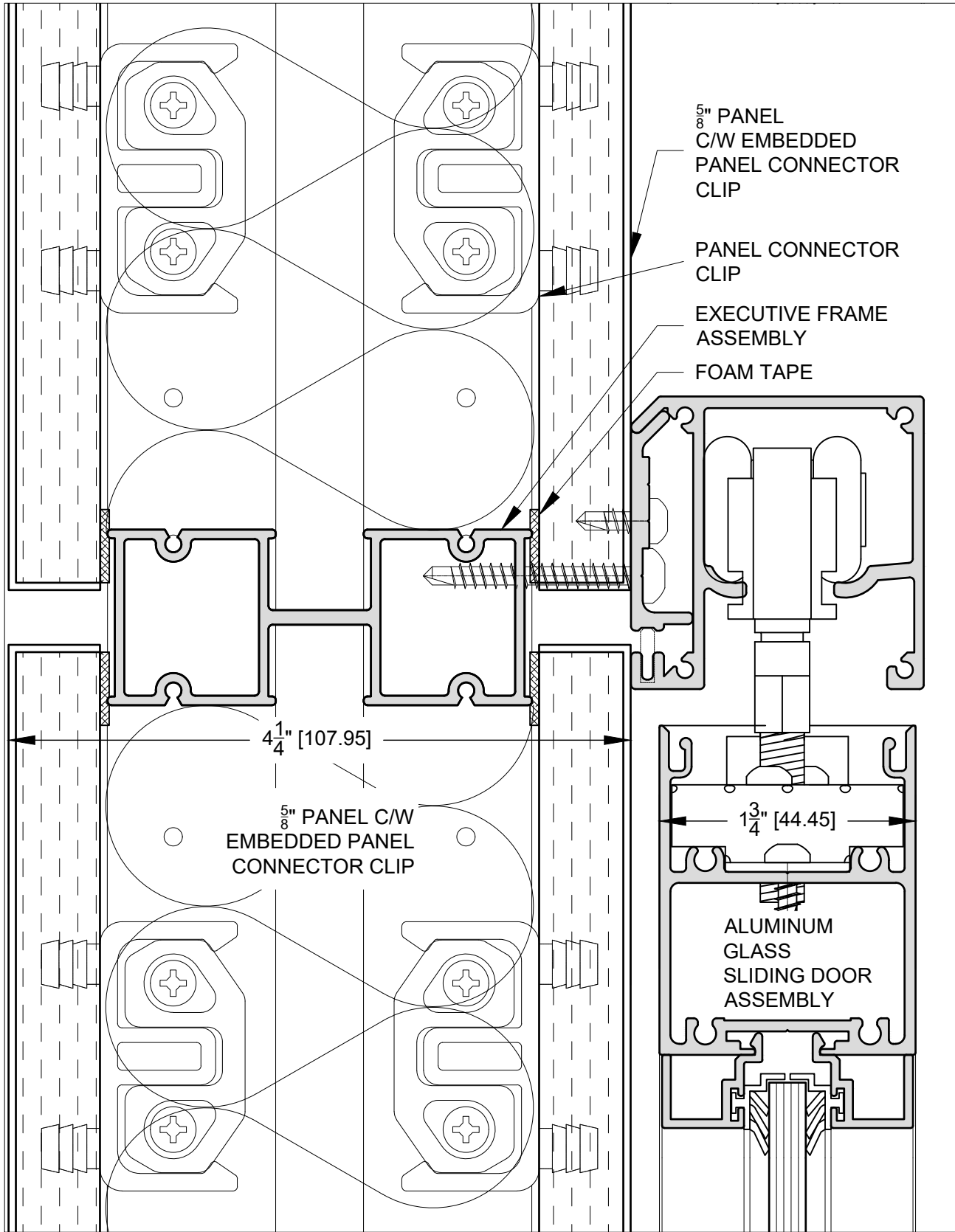

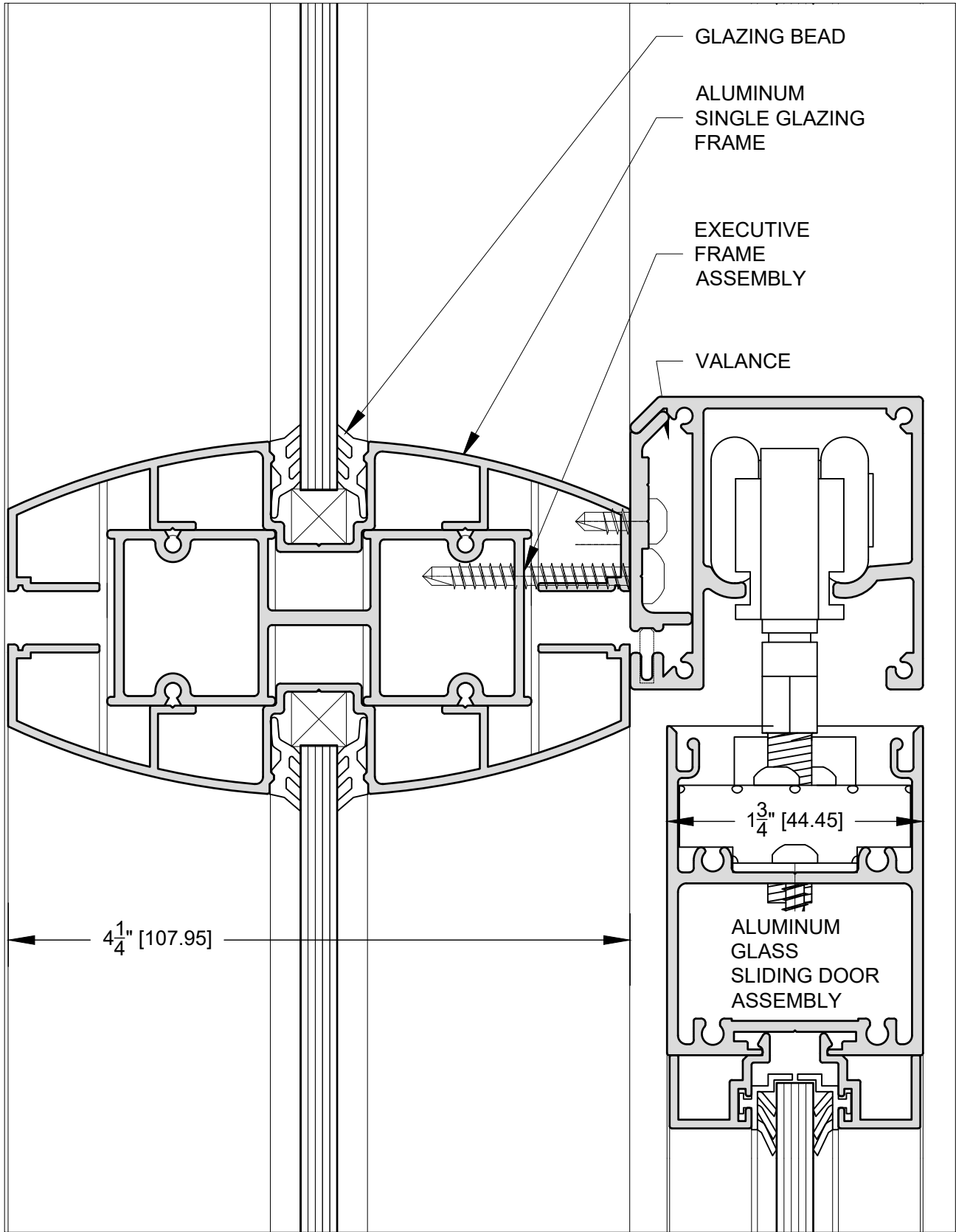

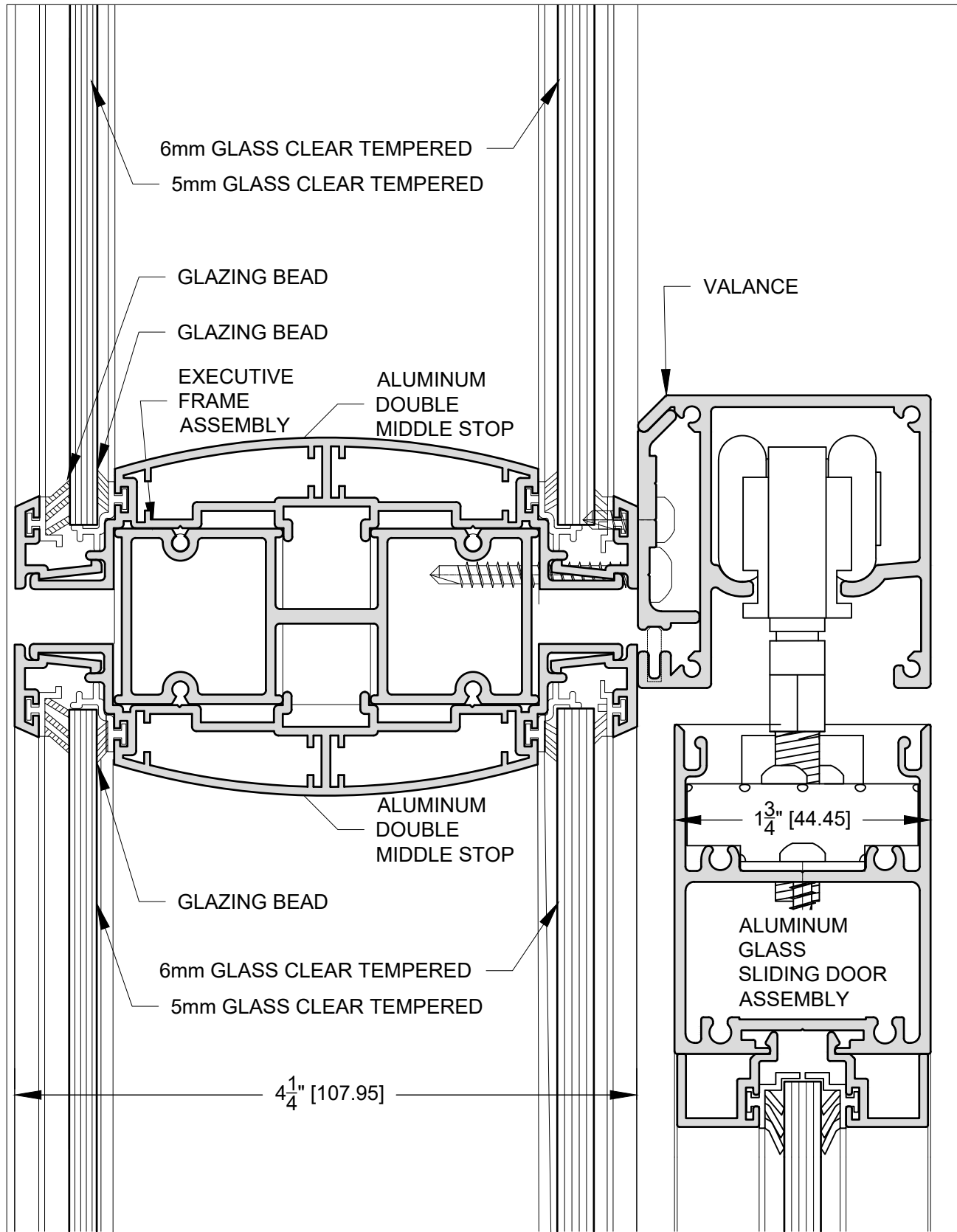

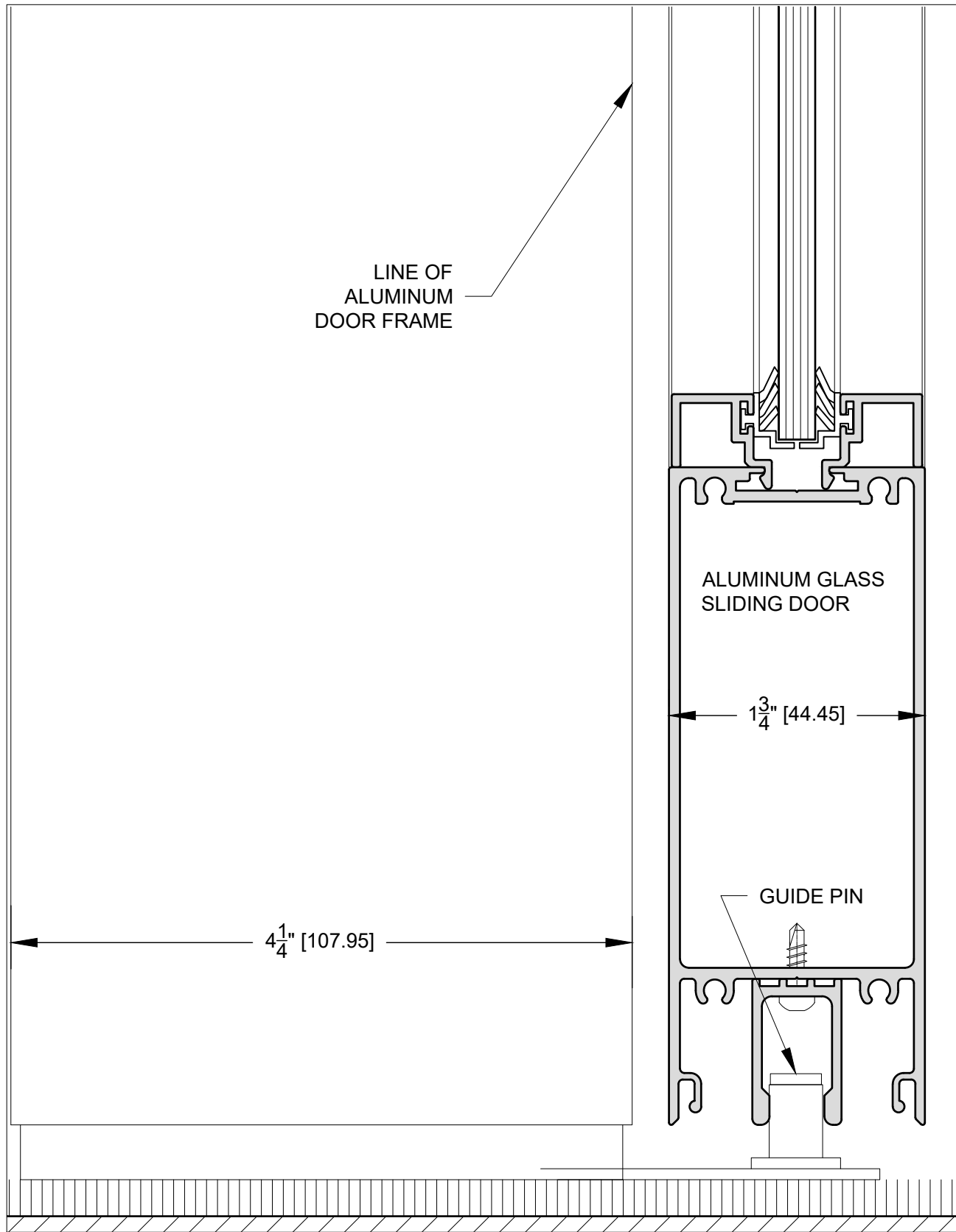

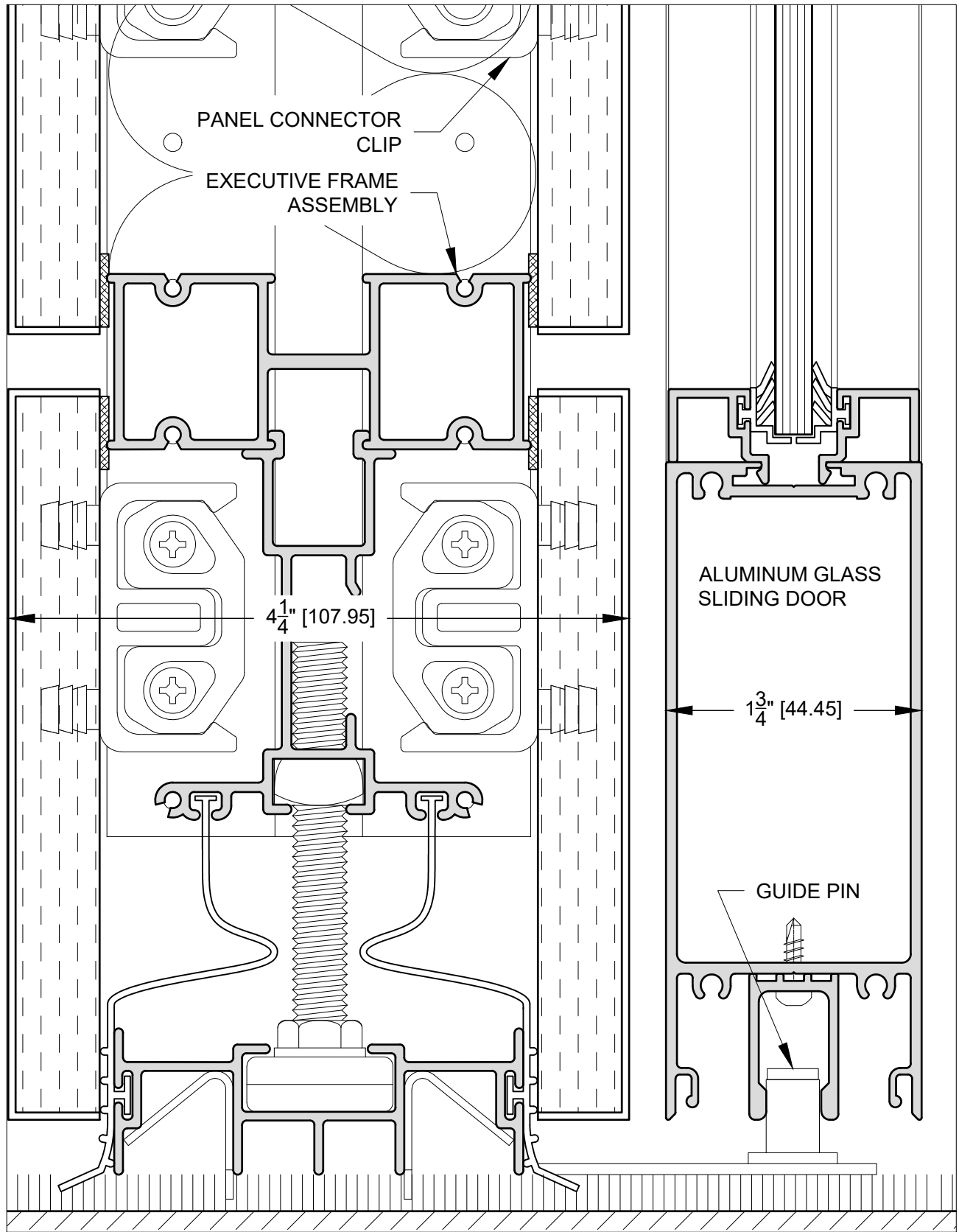

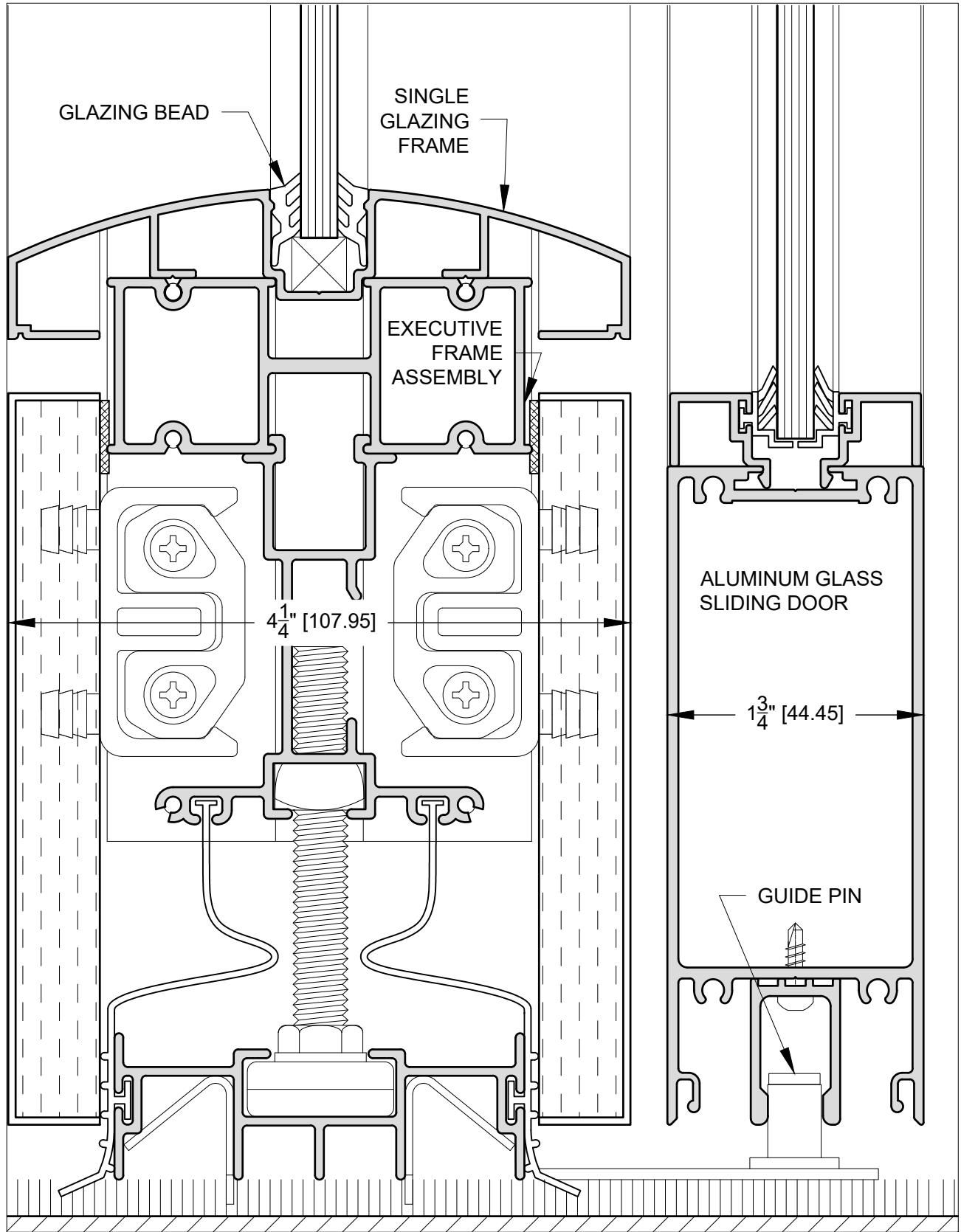

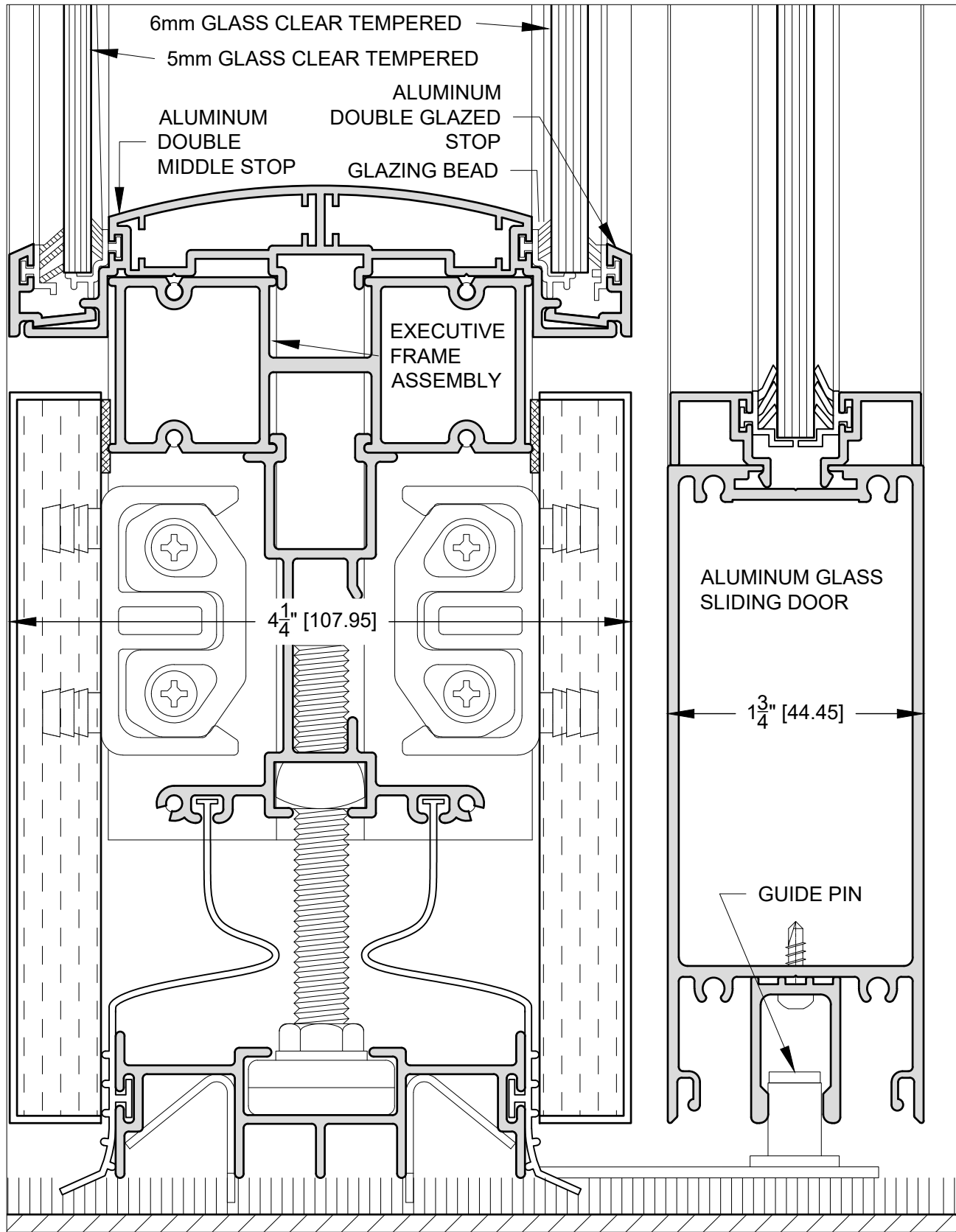

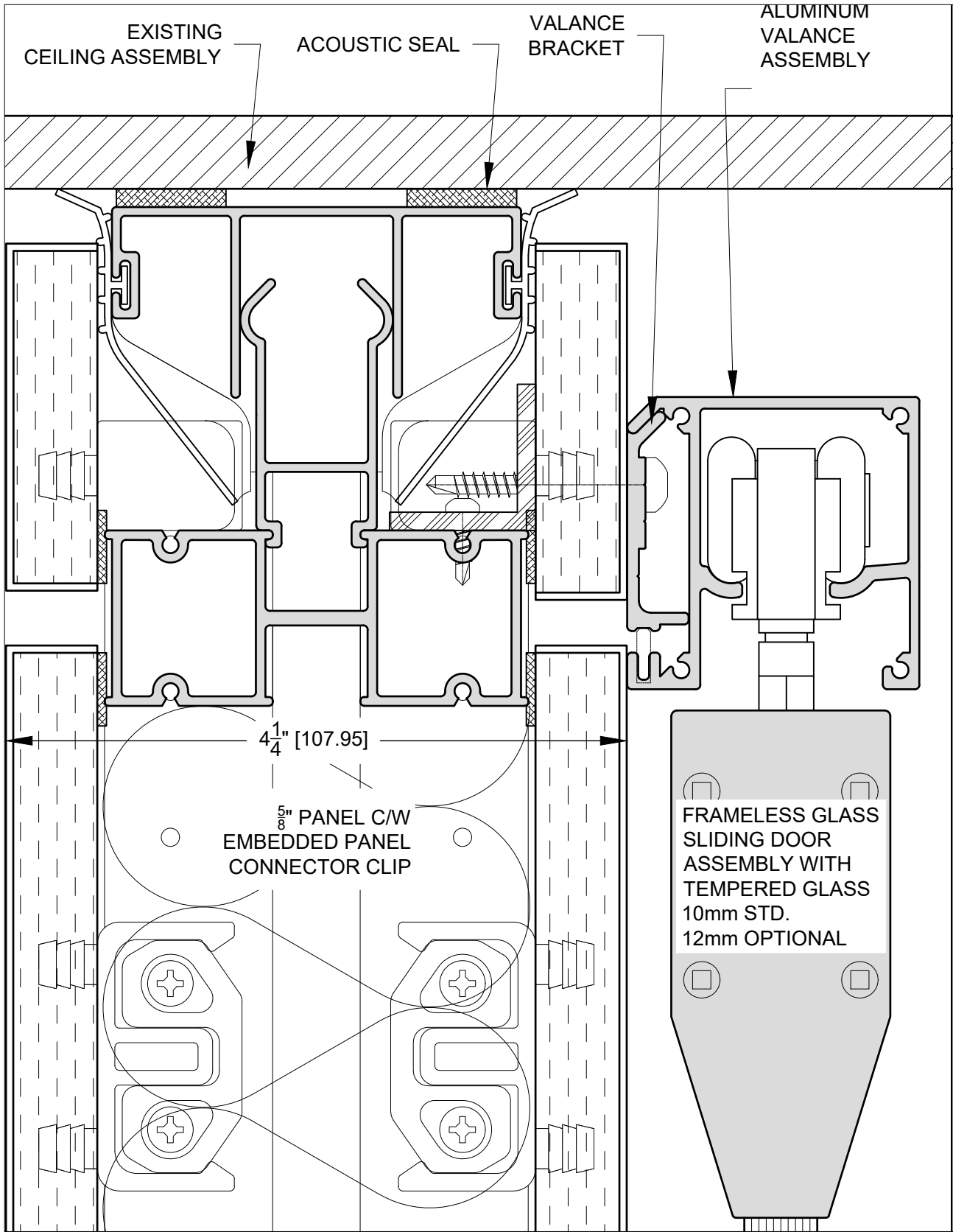



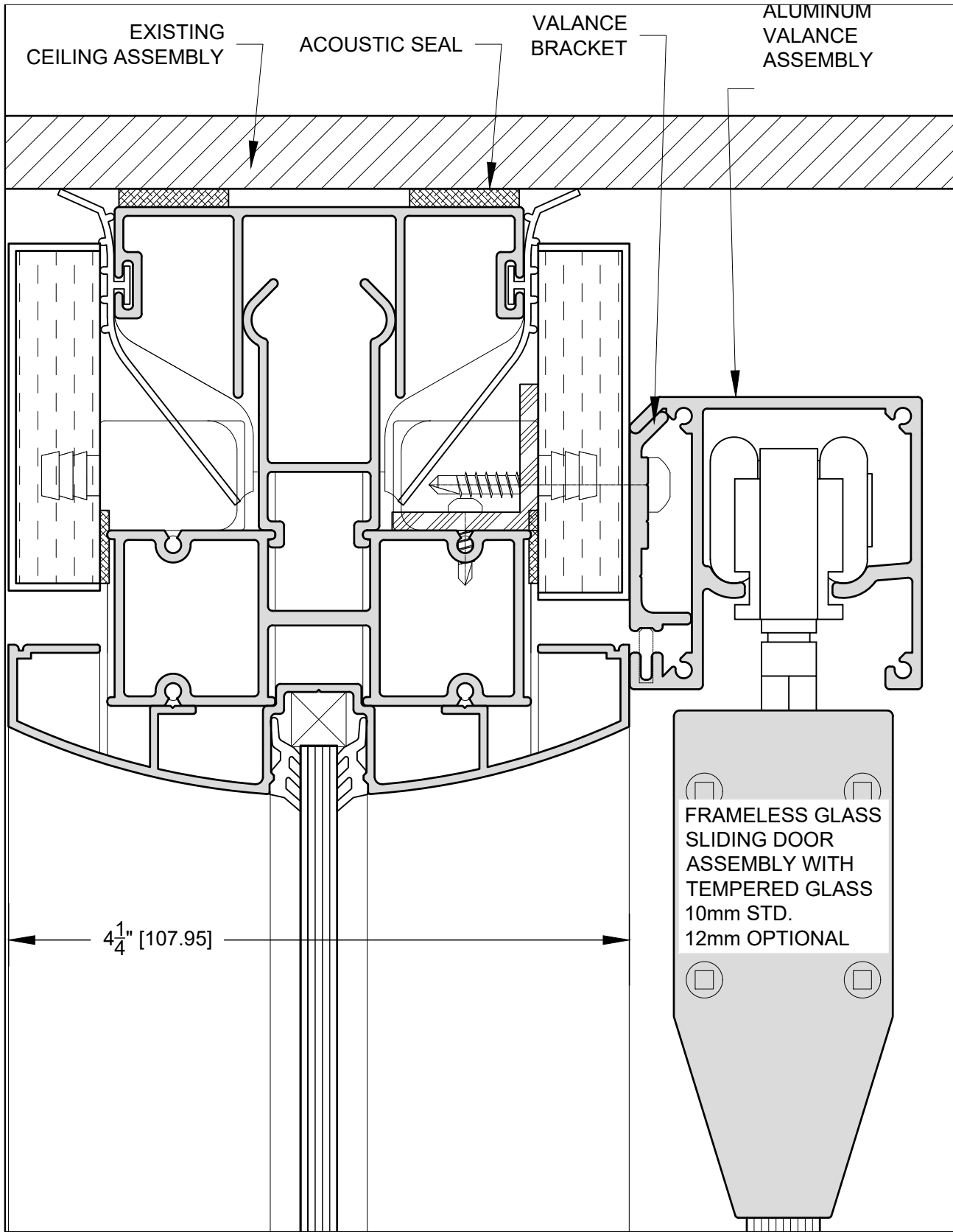

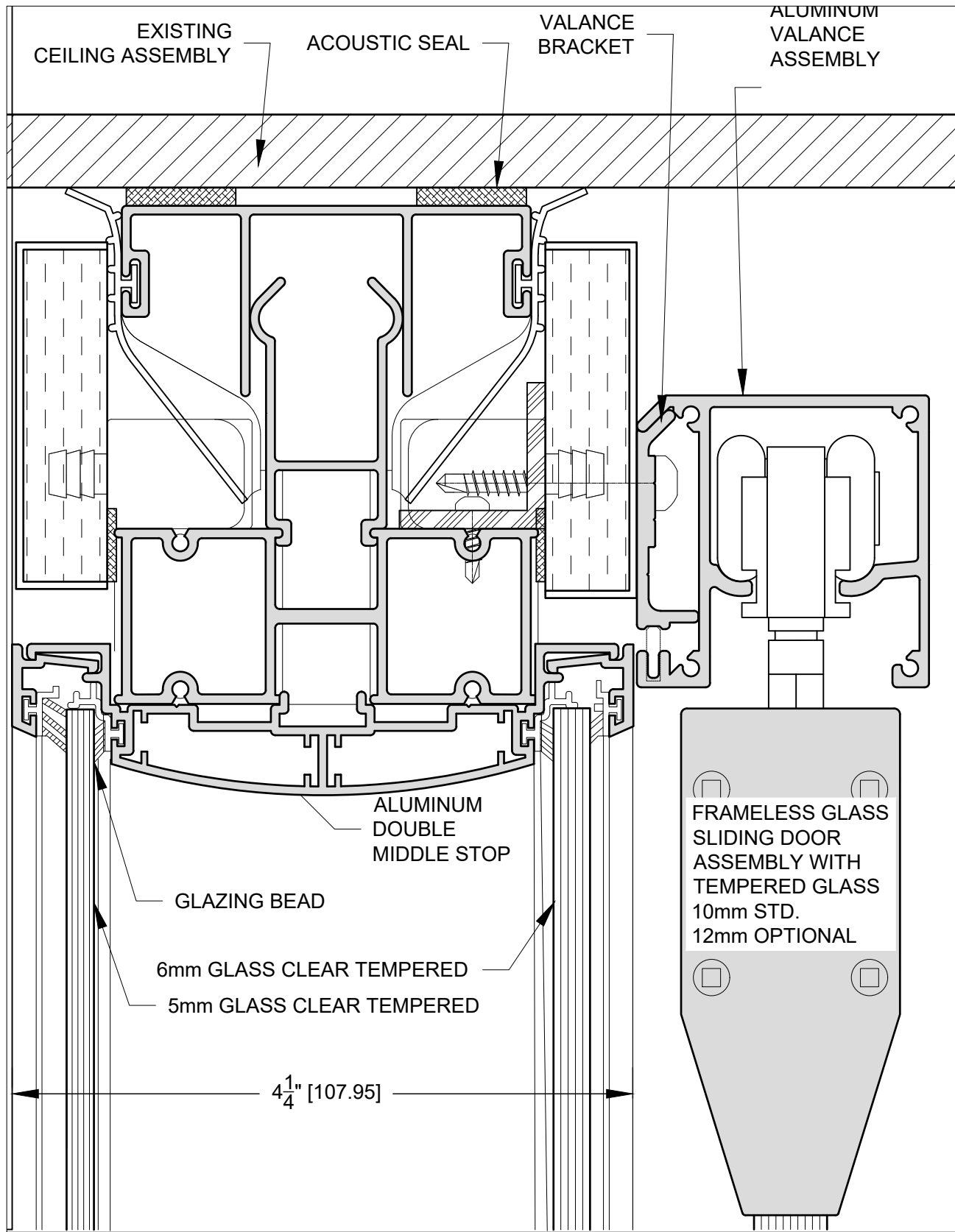

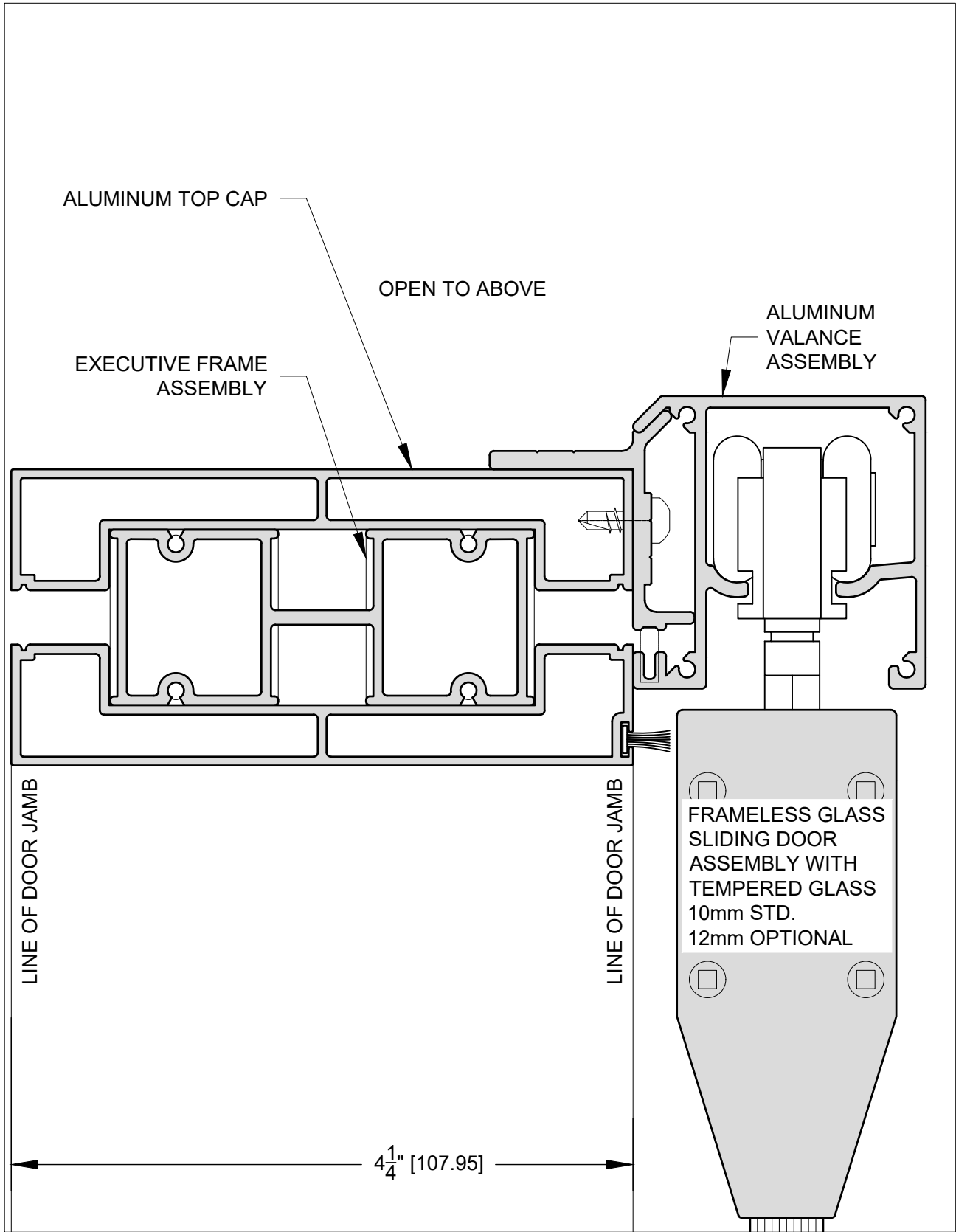

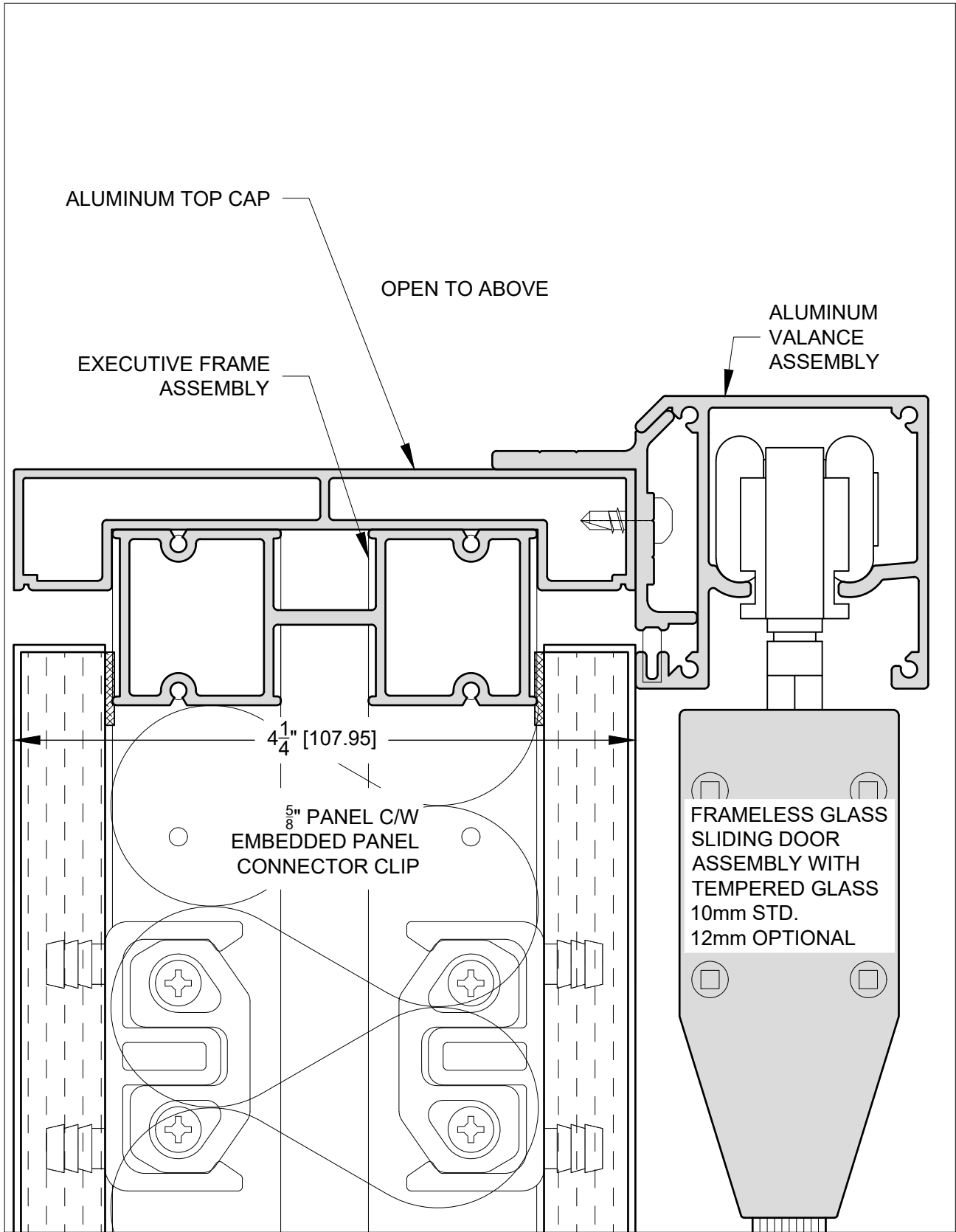

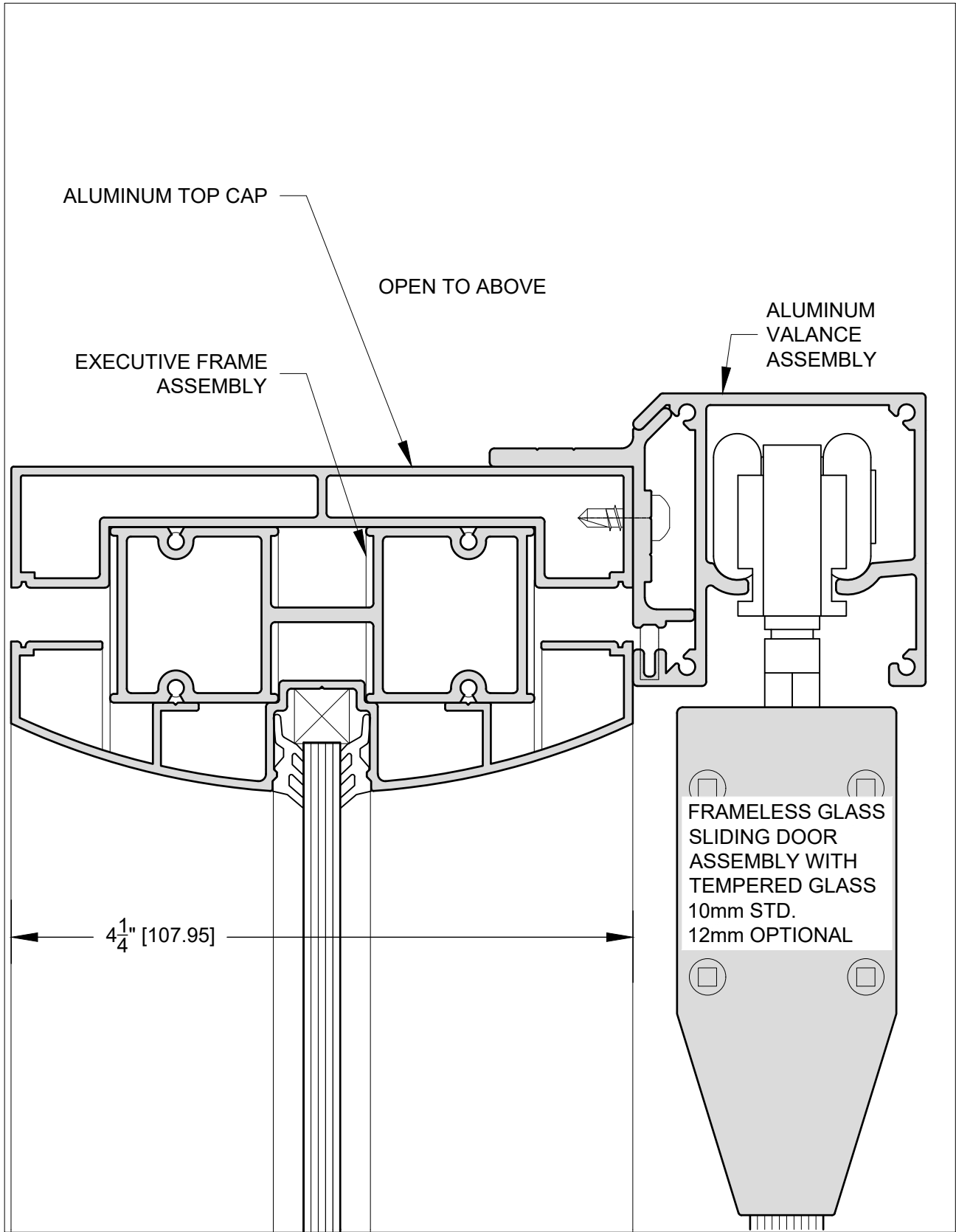

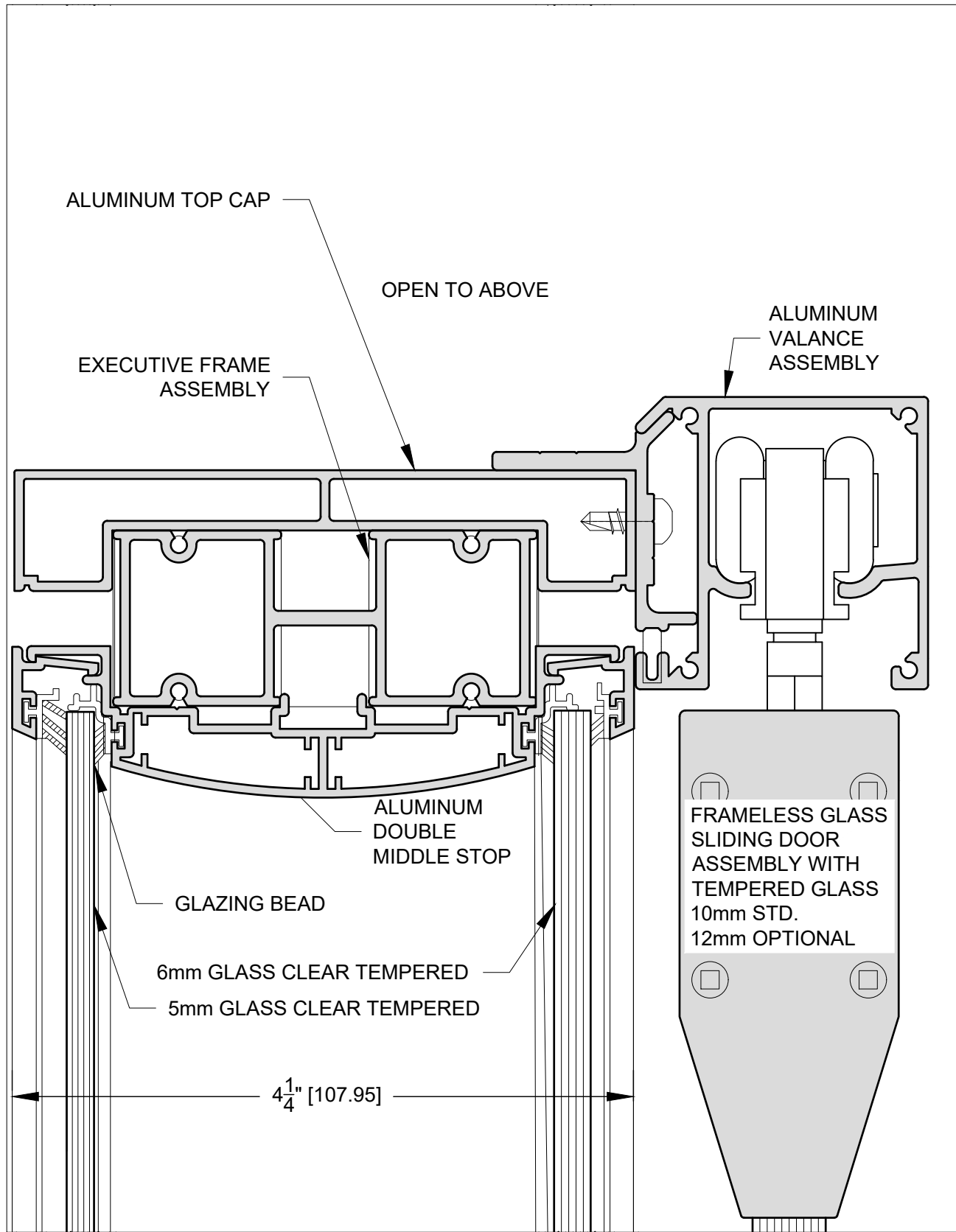

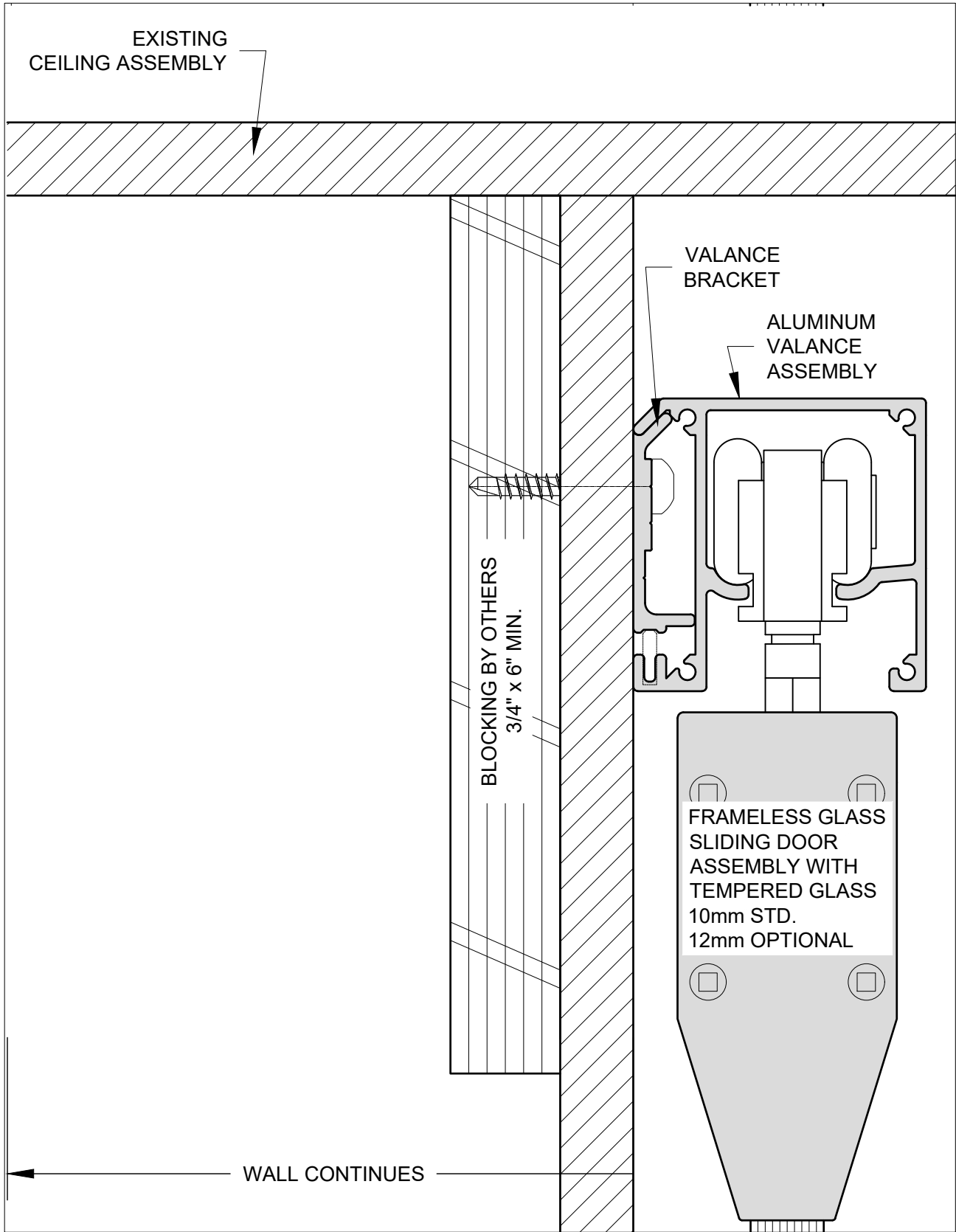

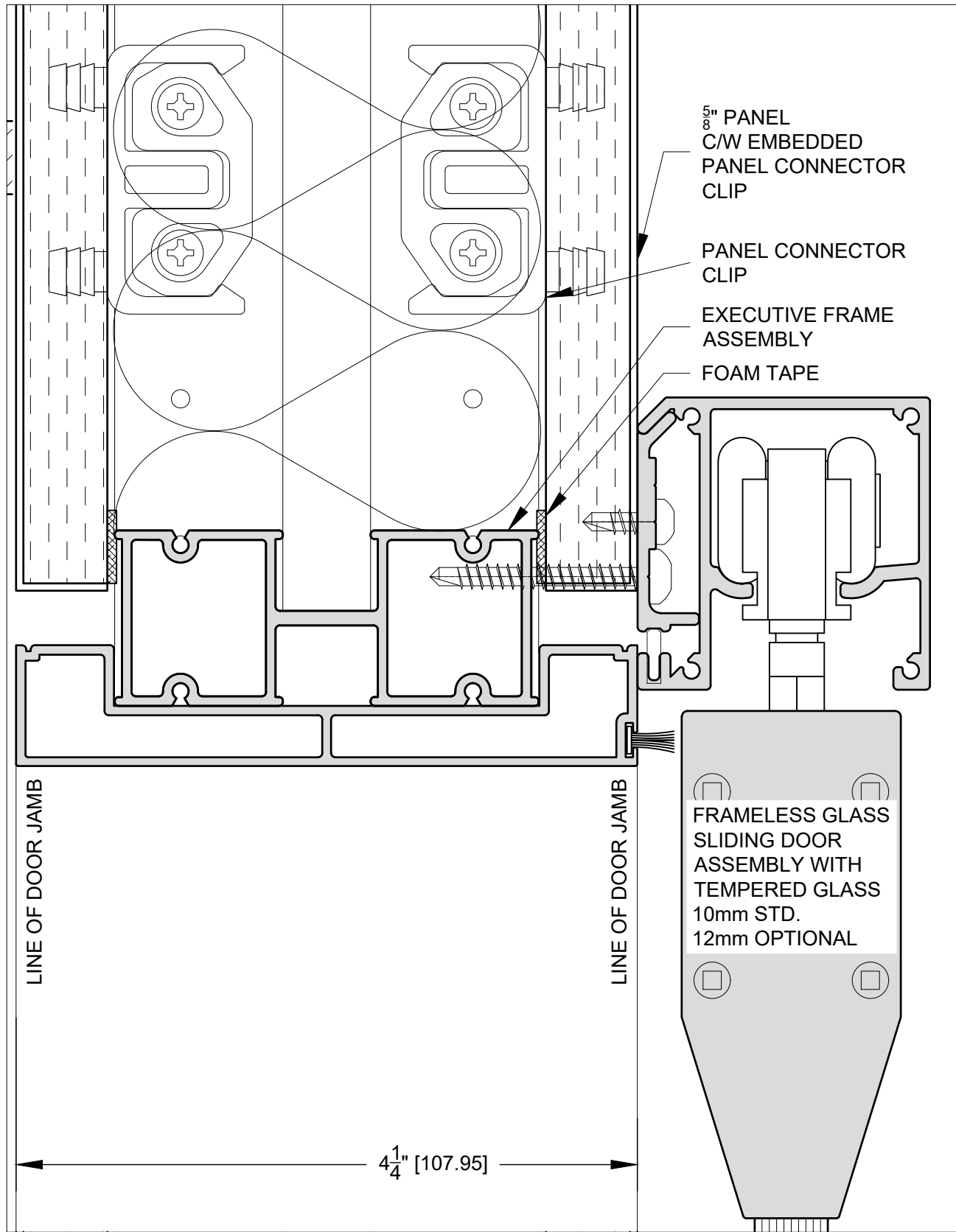

LINE OF DOOR JAMB

LINE OF DOOR JAMB

4 1/4" [107.95]



**FRAMLESS GLASS  
SOLID TRANSOM, DOORWAY**

DWG:

**1.4.3.2**

FILE:

SCALE: 1 : 1

DATE: OCT 2020



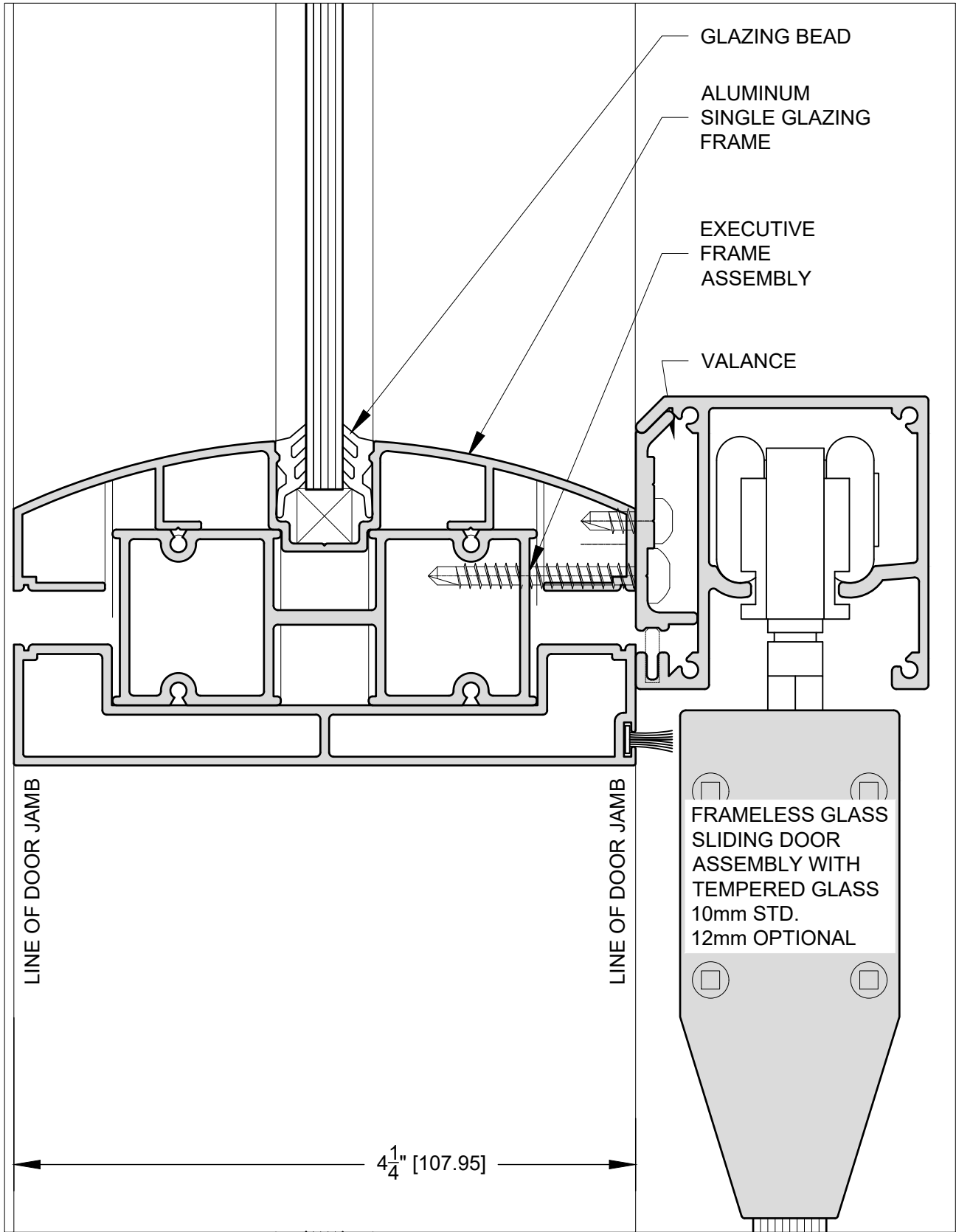

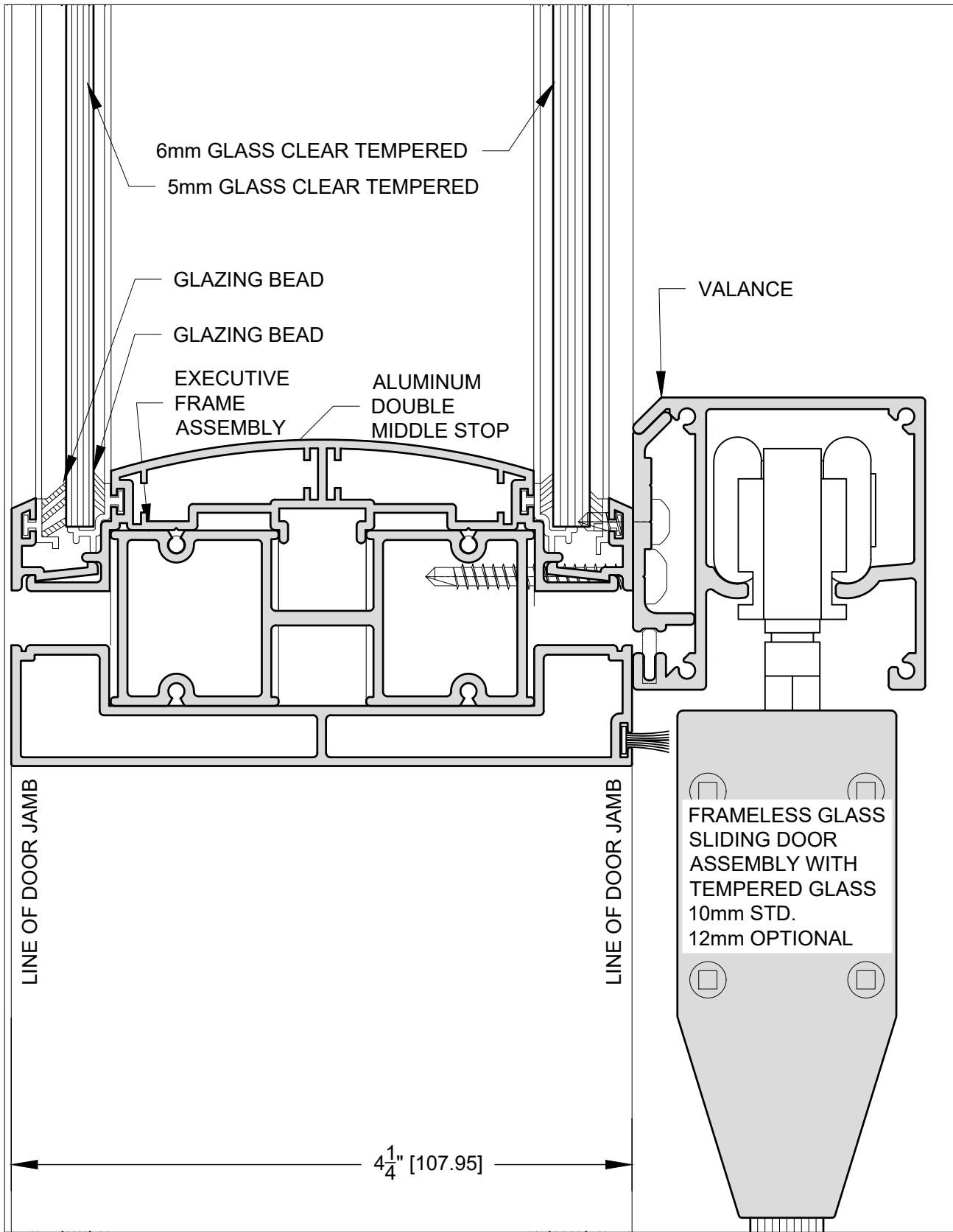

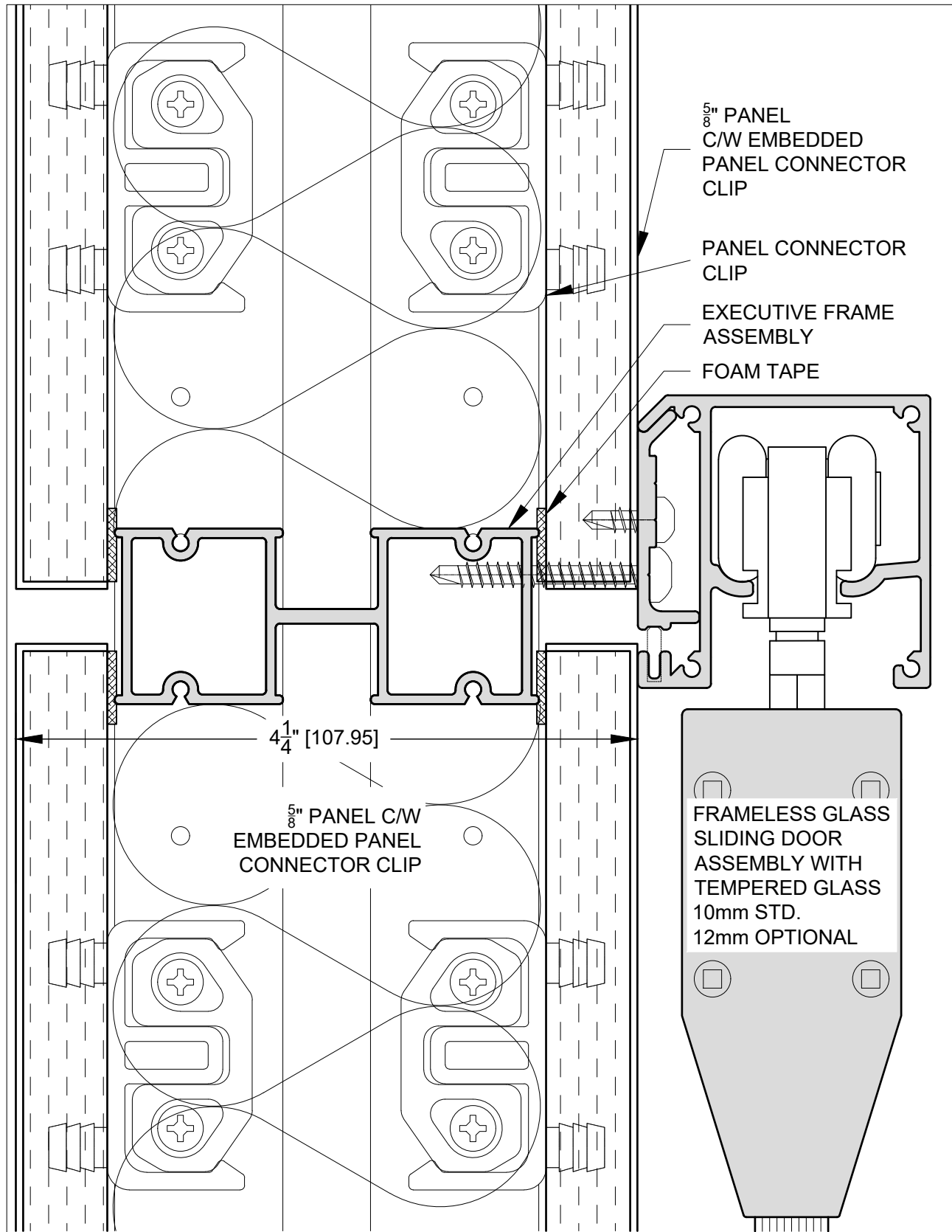

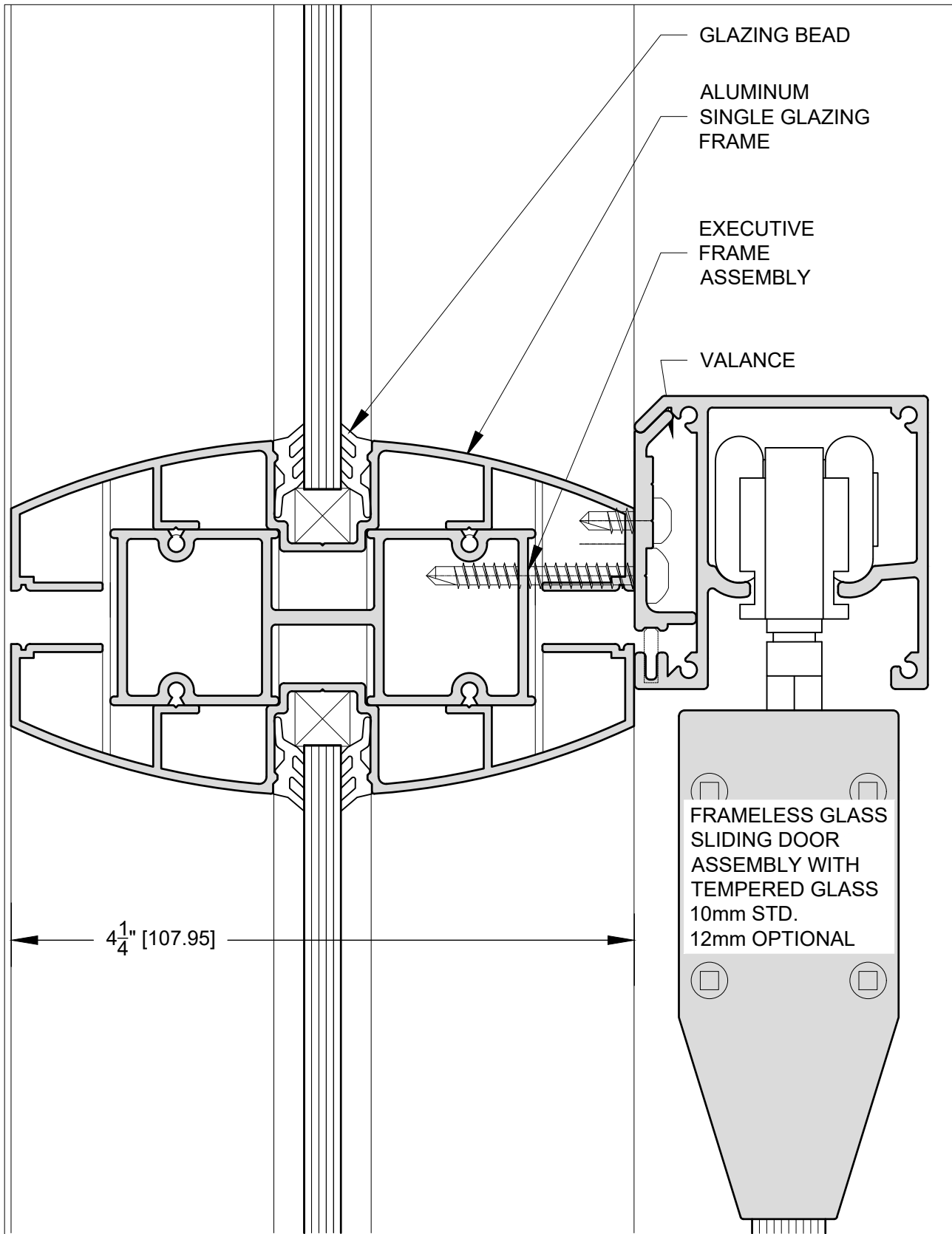

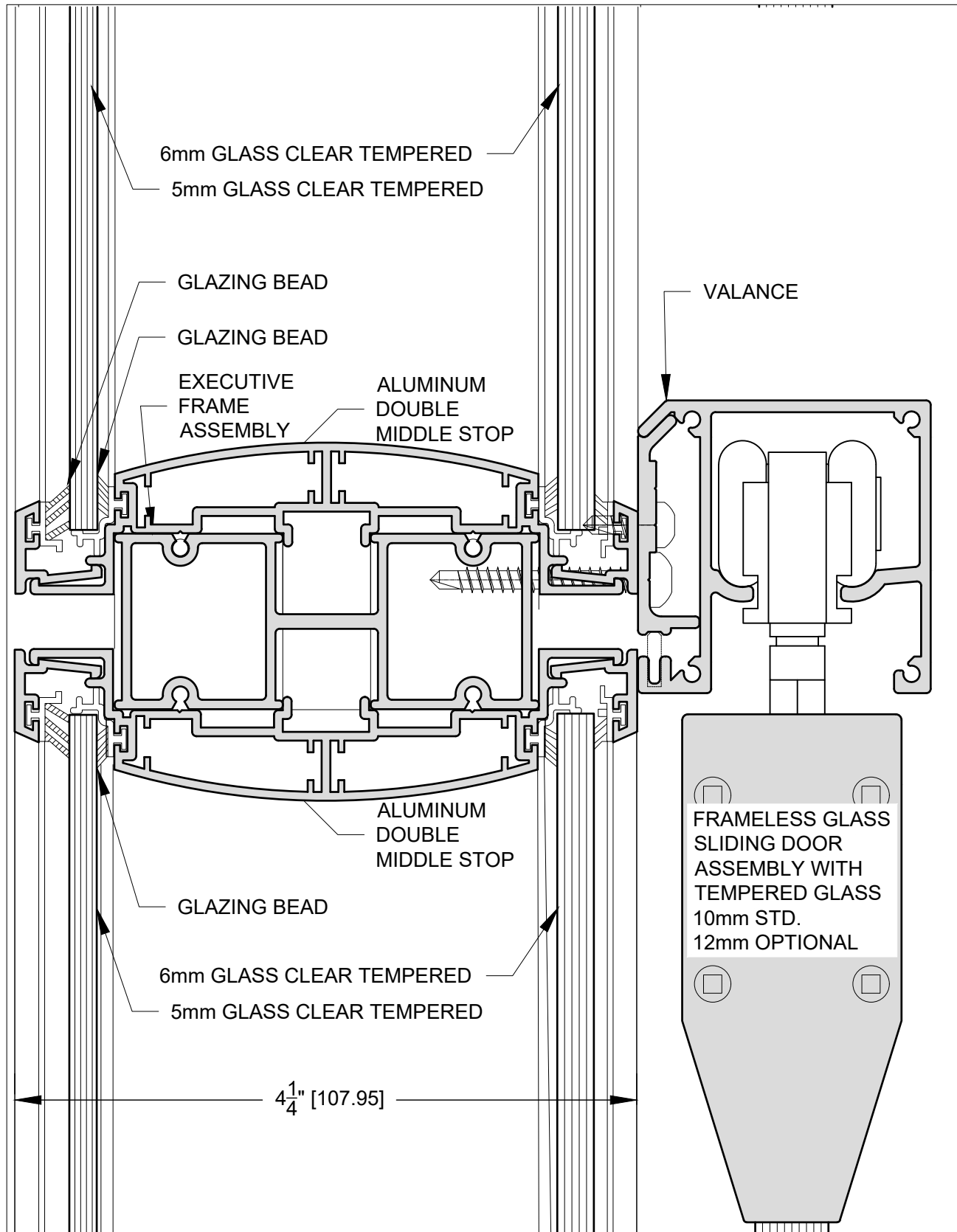

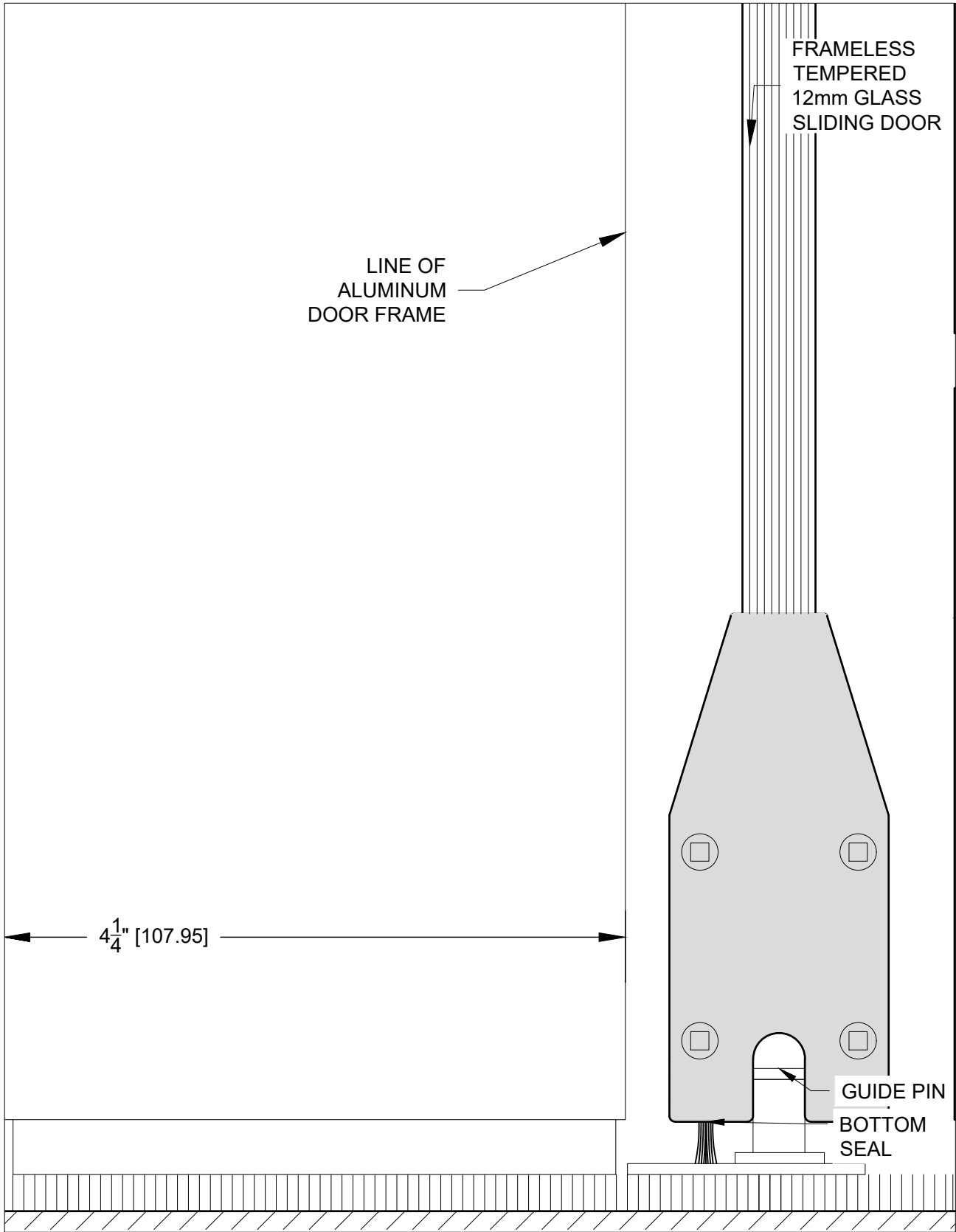

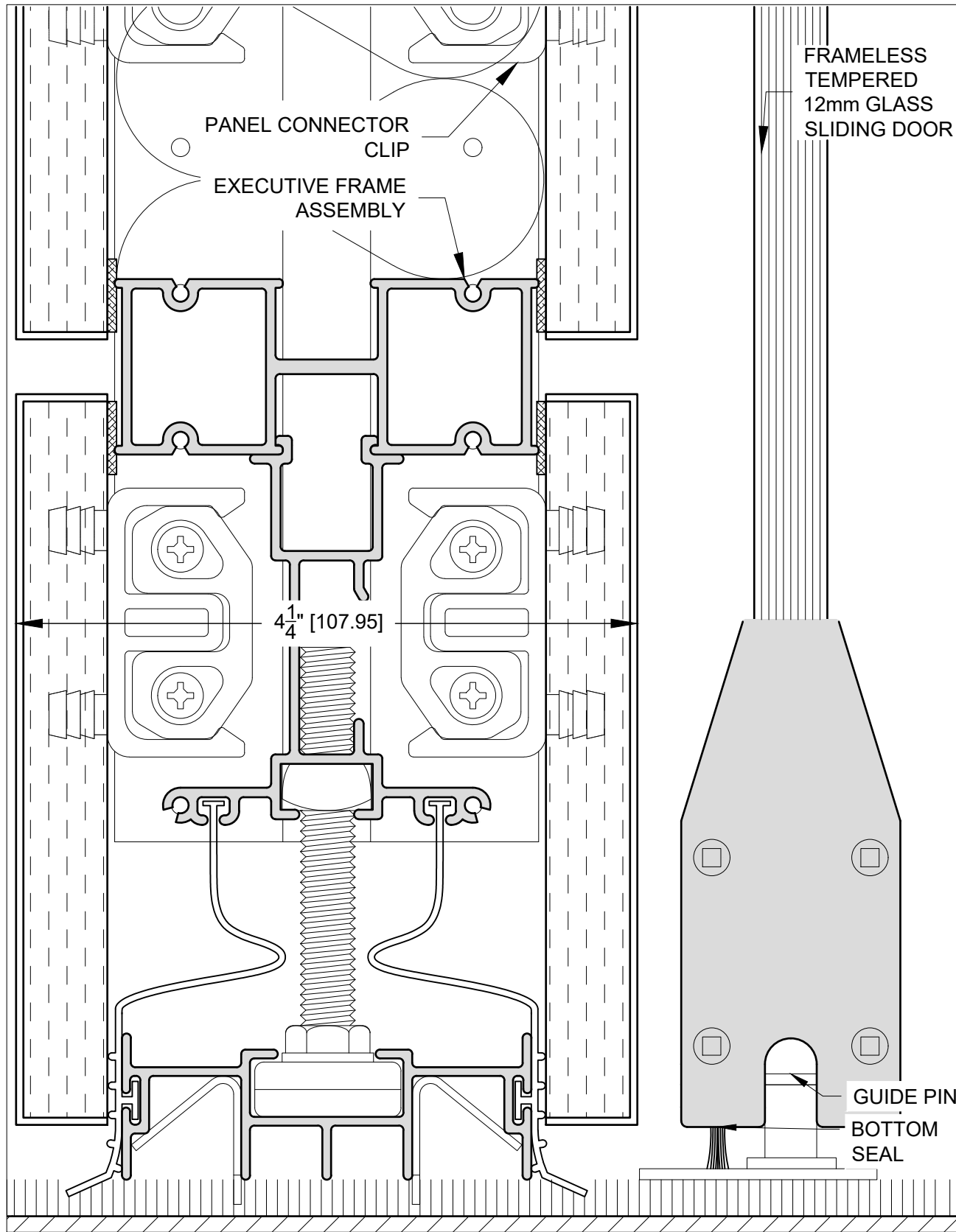

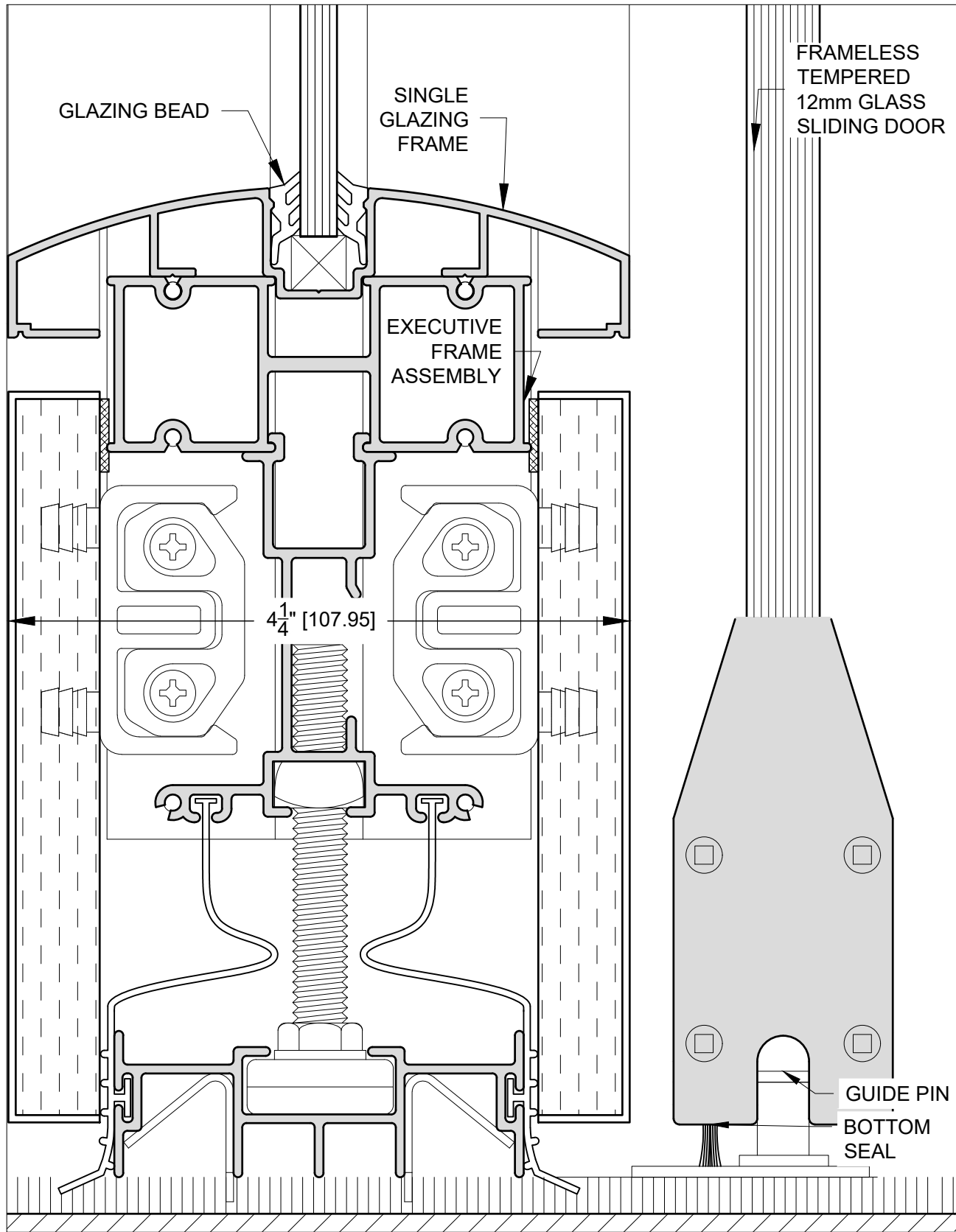



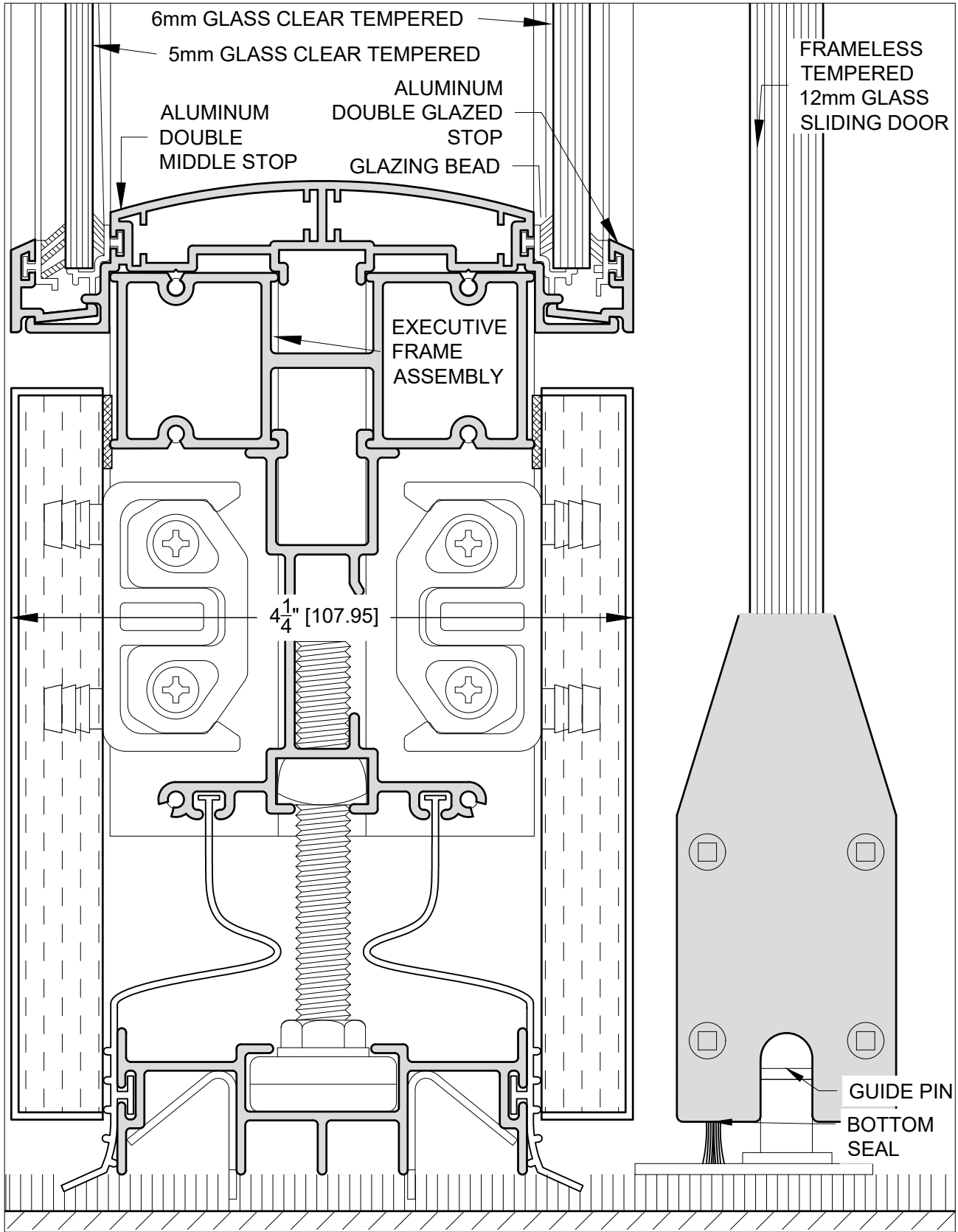

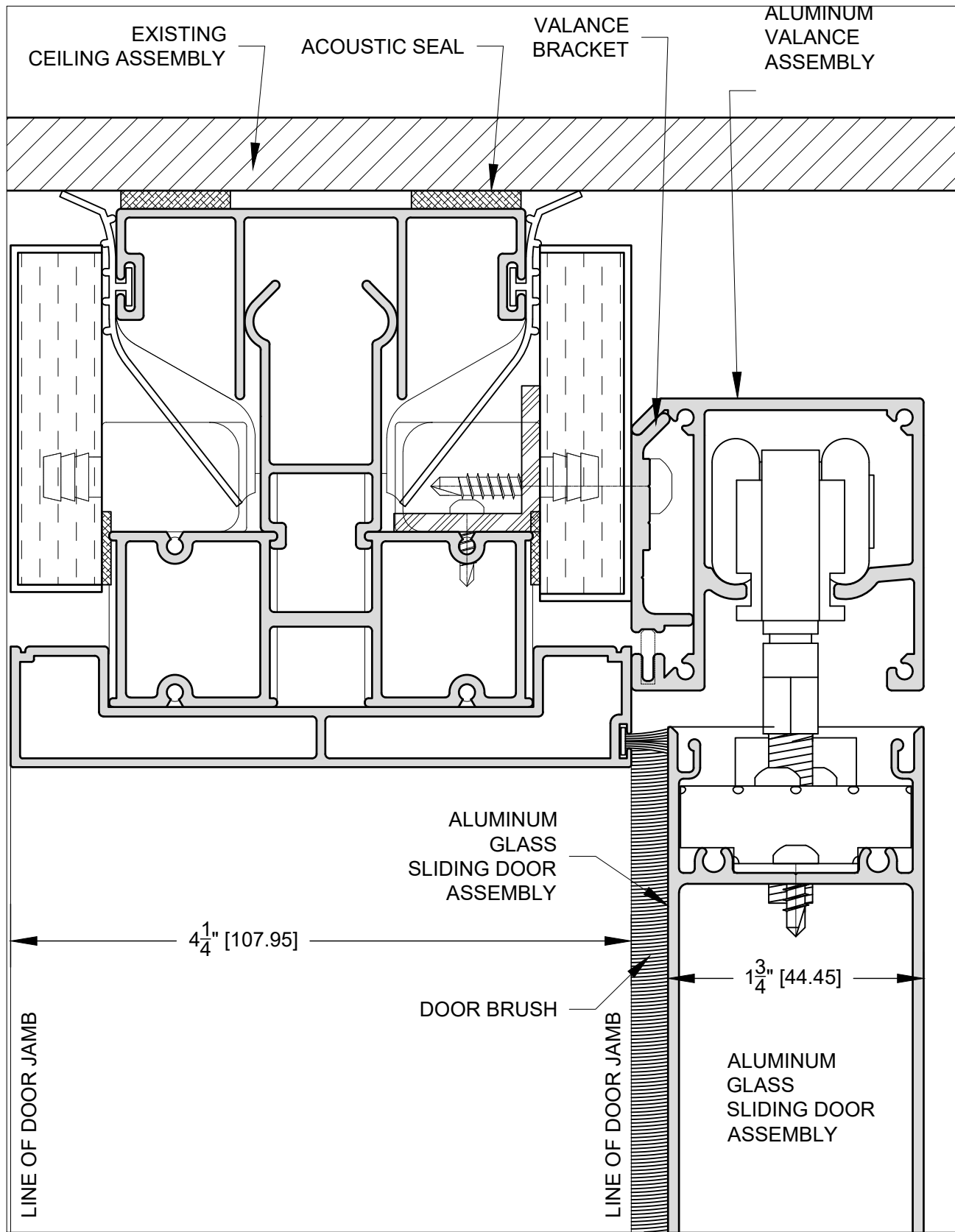

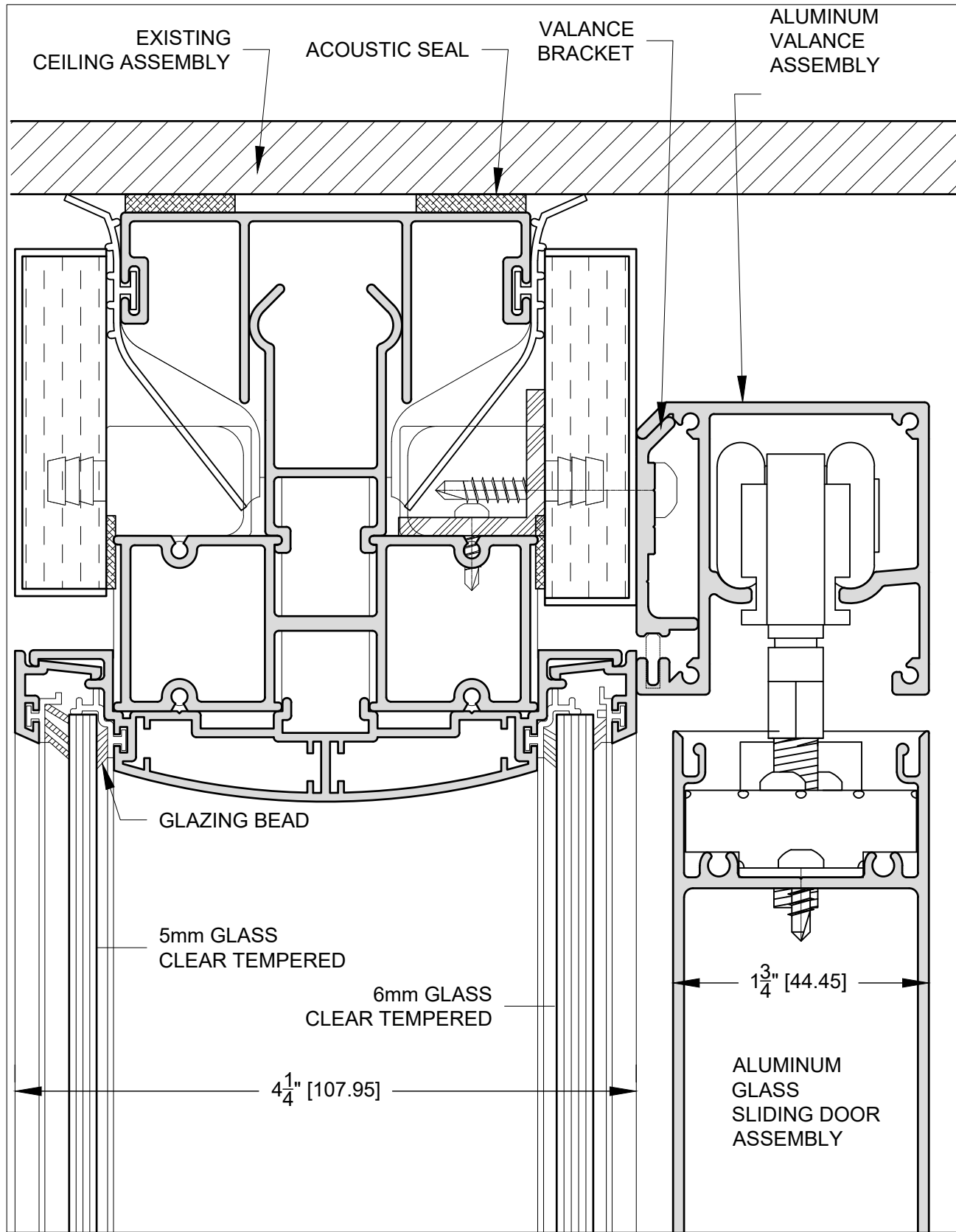

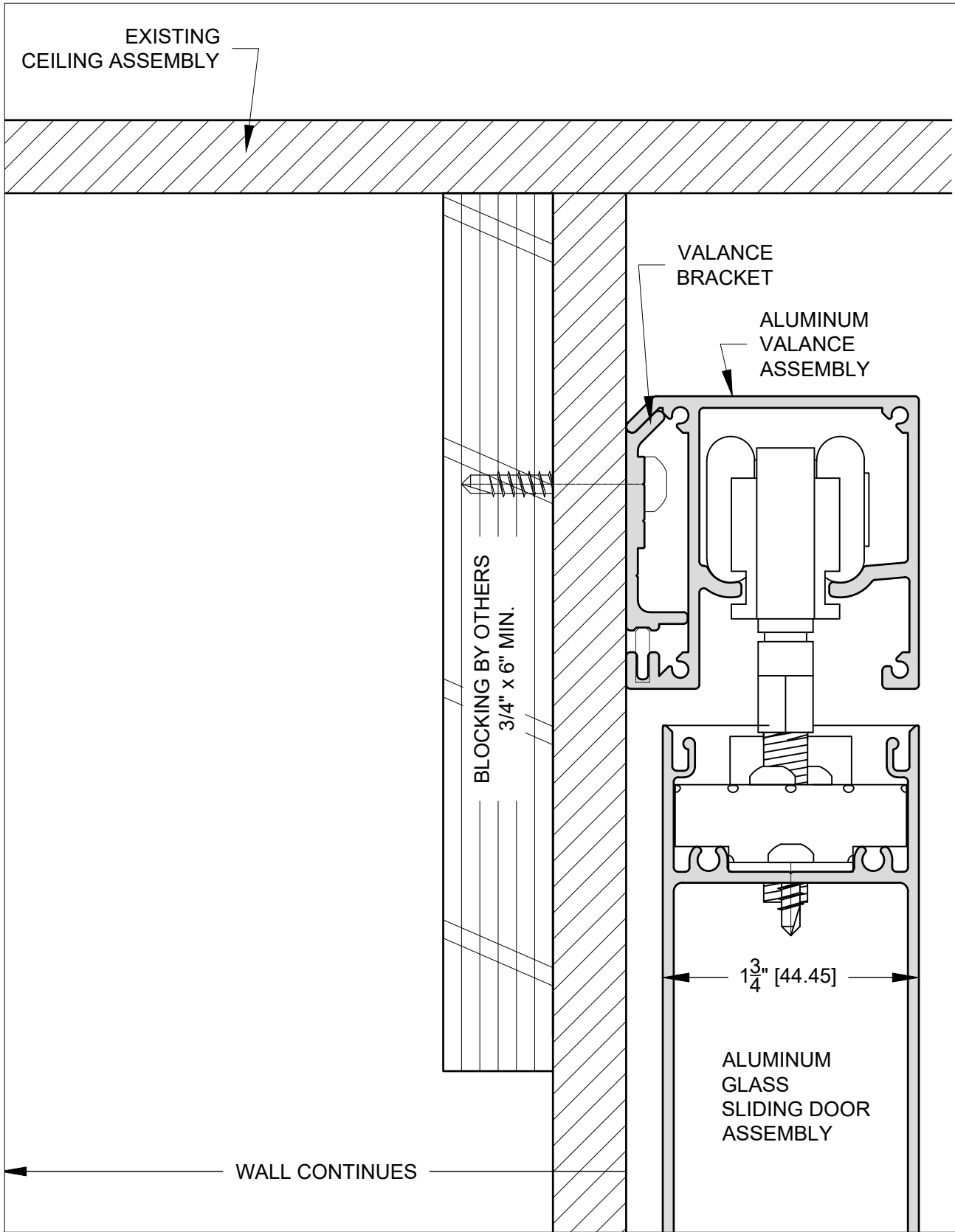

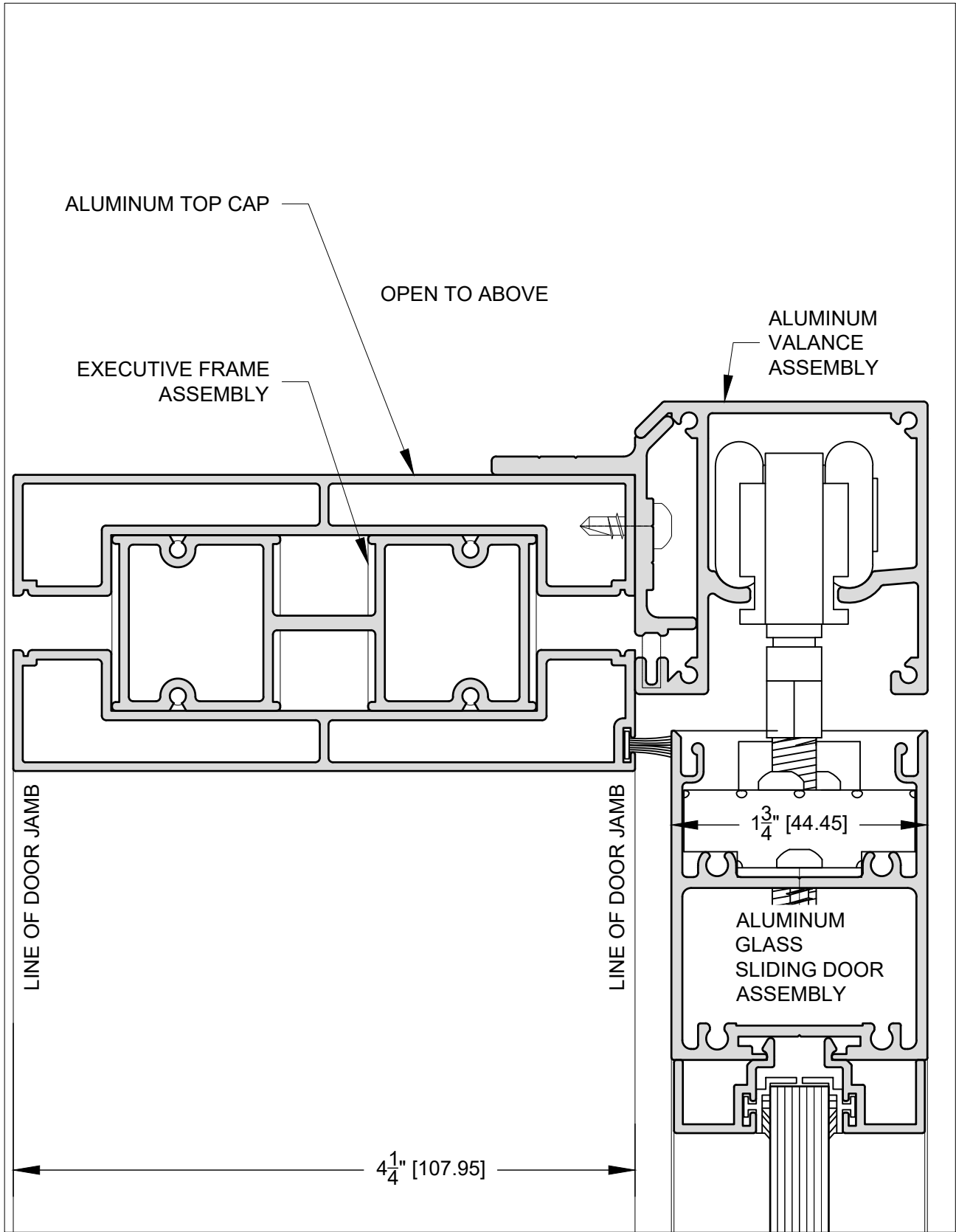

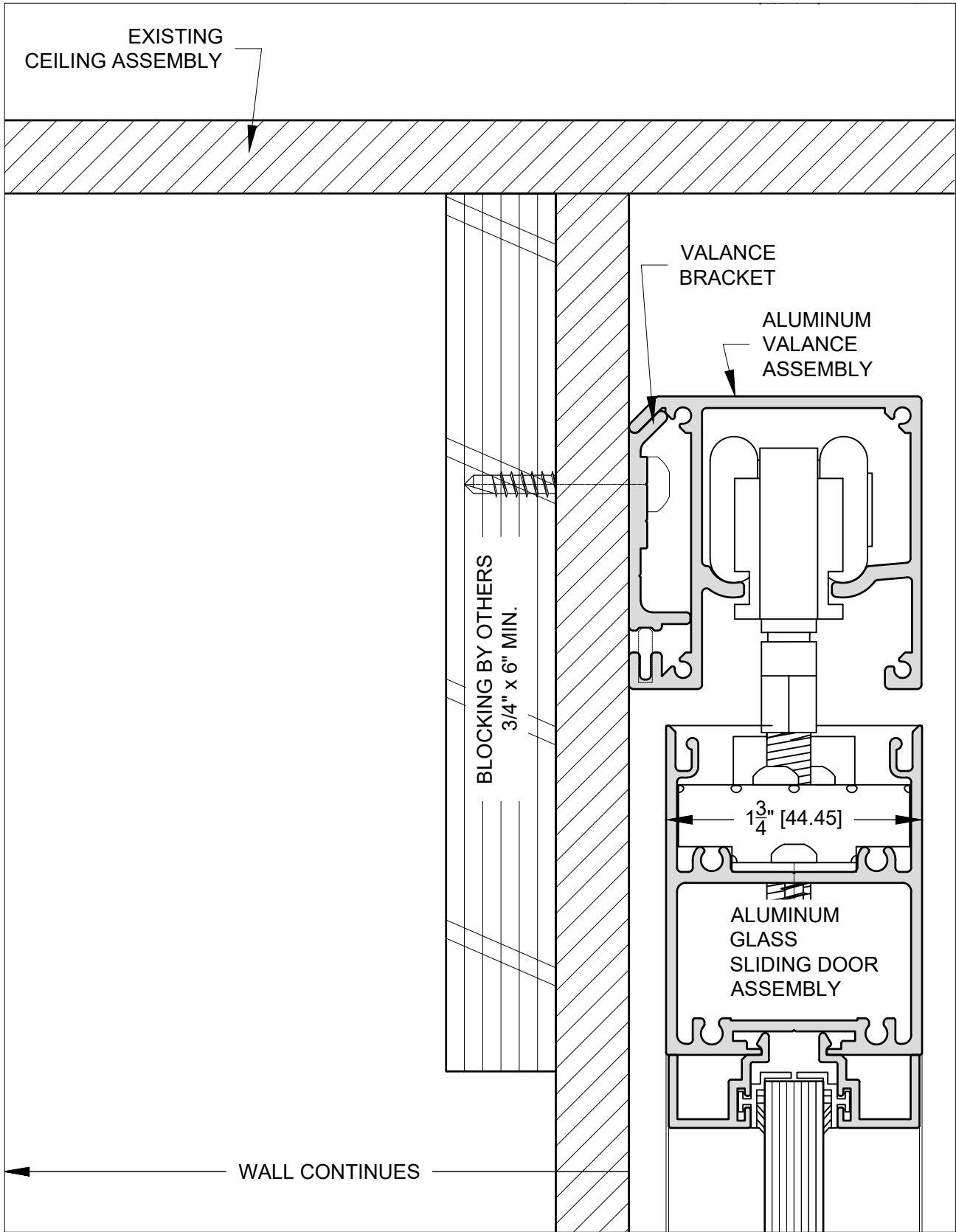

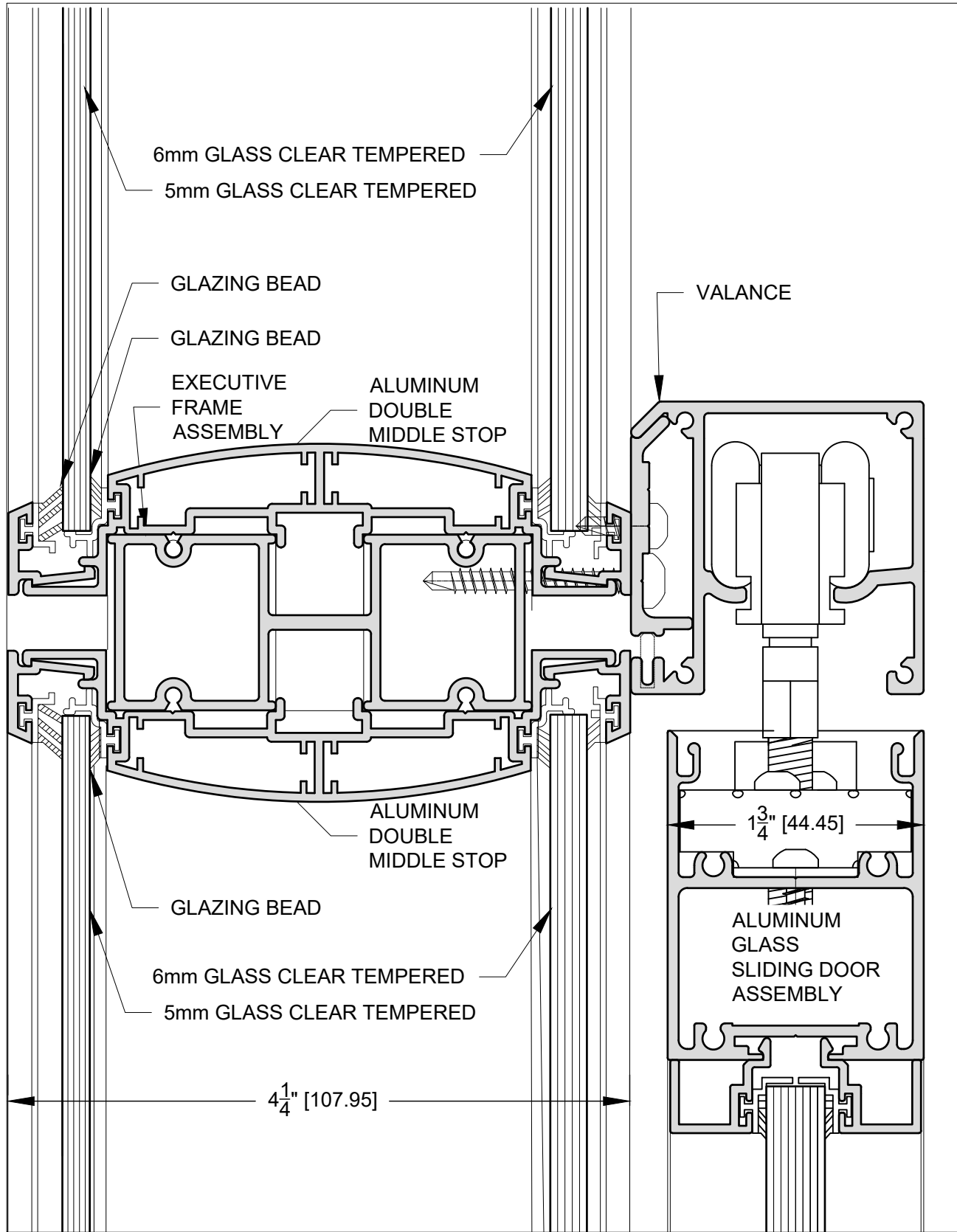

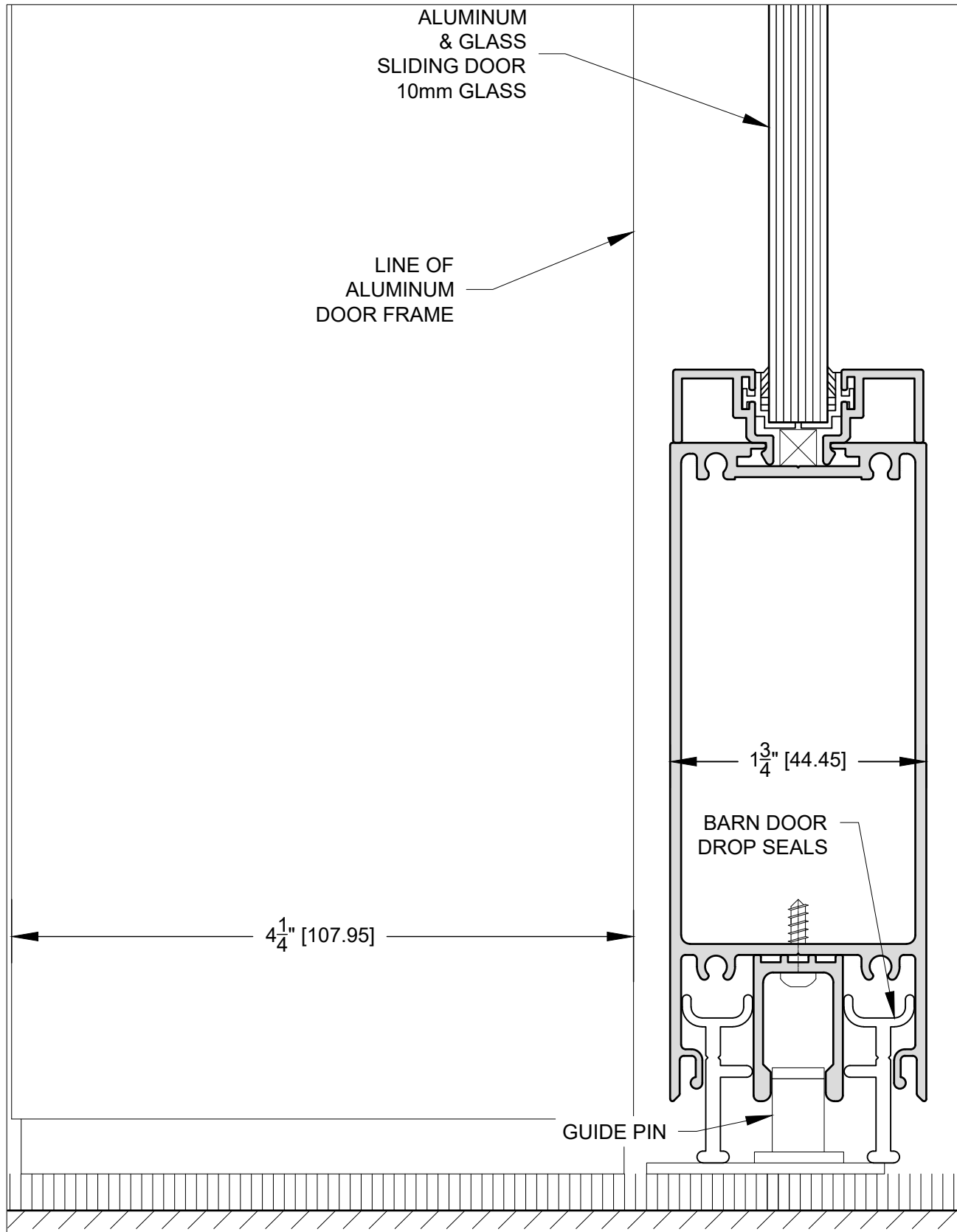



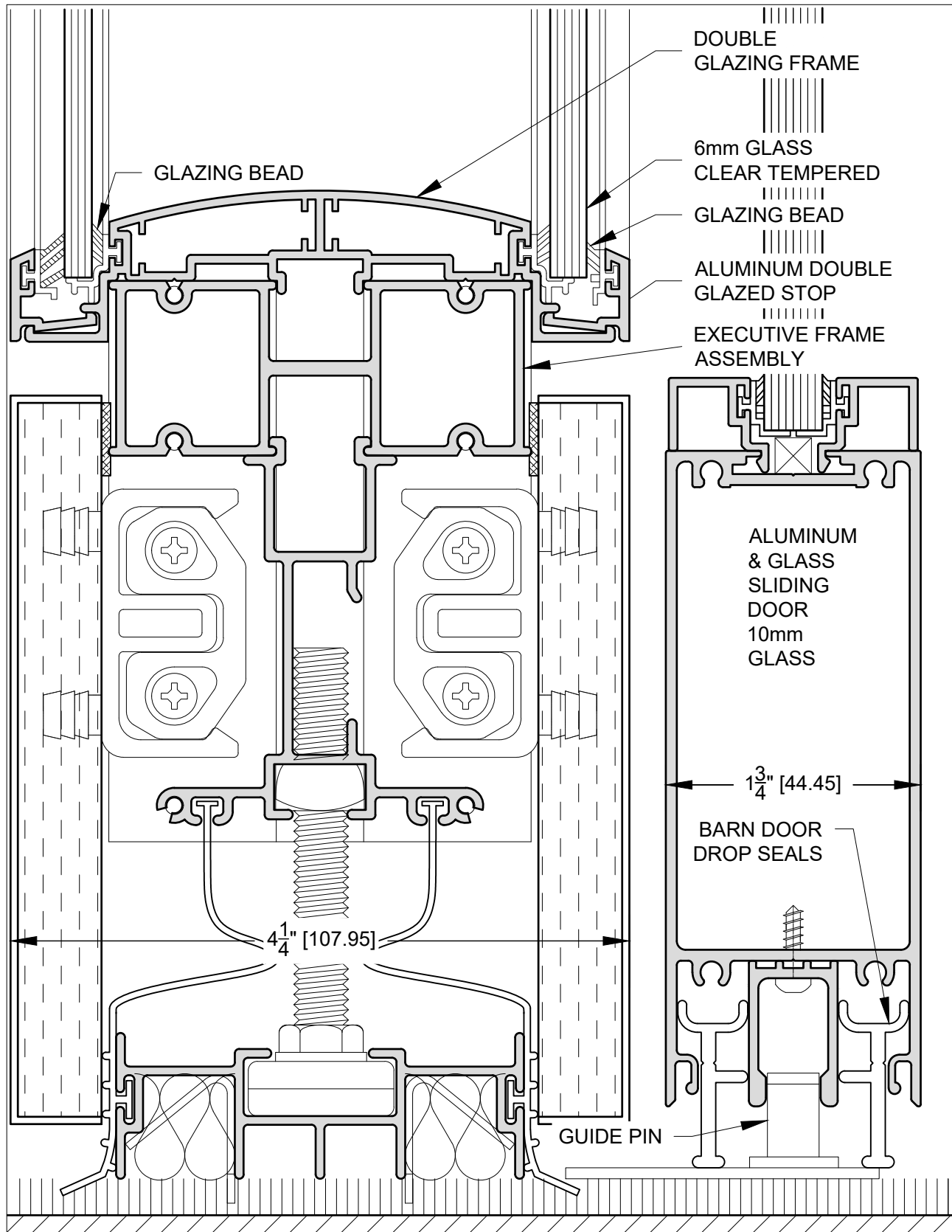

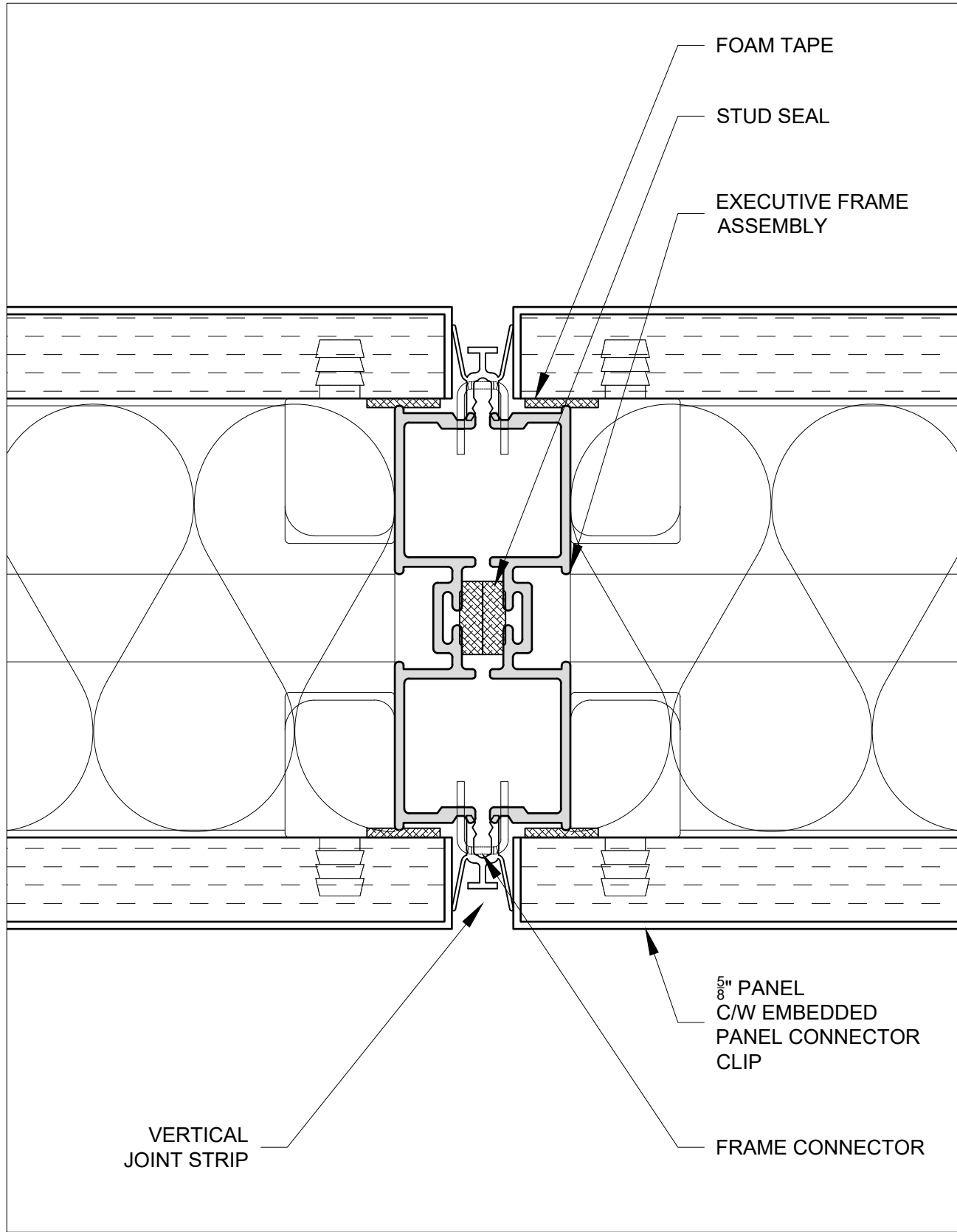

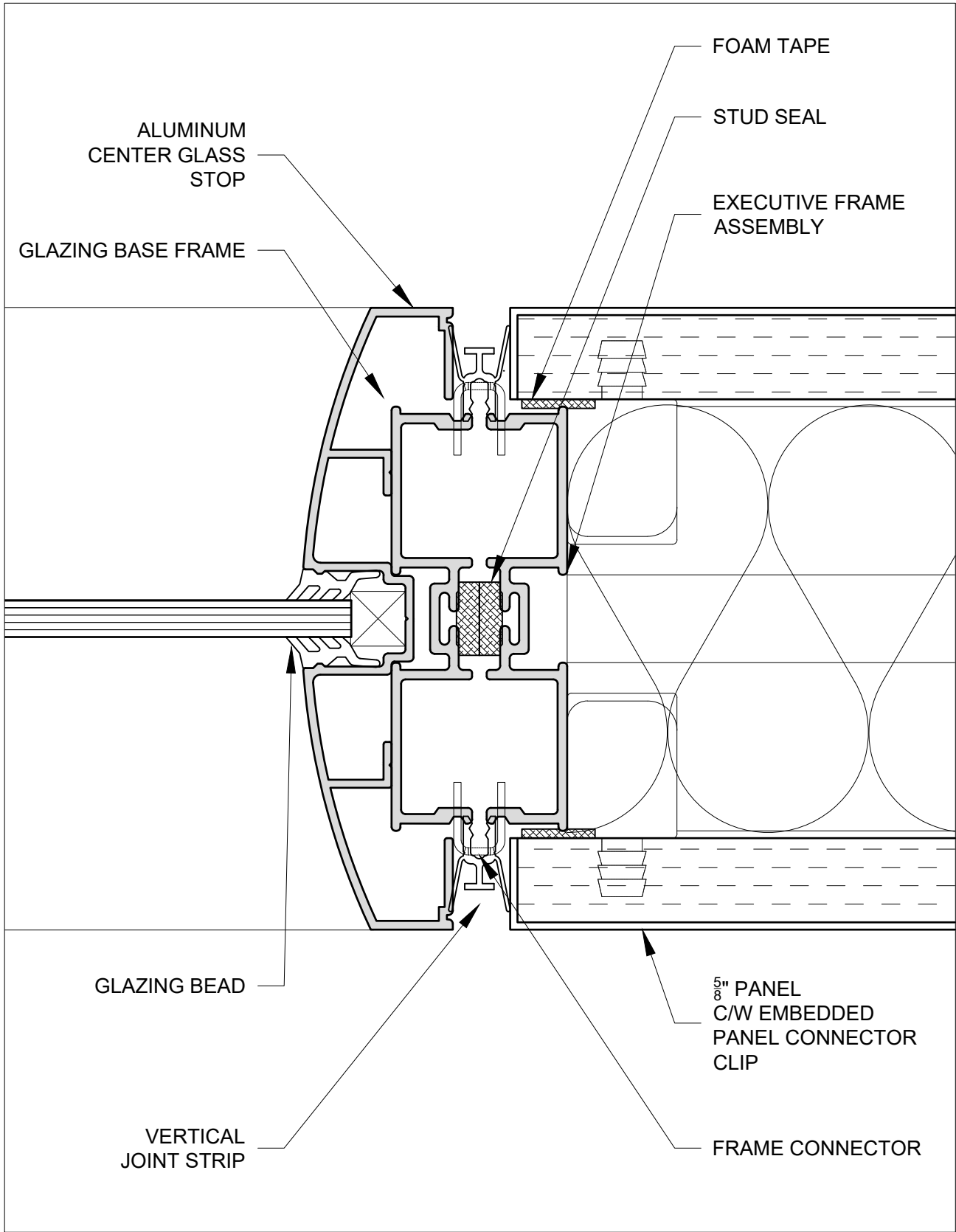

	<p><b>SINGLE GLAZING-SOLID WALL TRANSITION</b></p>	<p>DWG: <b>2.1.1.2</b></p>
<p>FILE:</p>	<p>SCALE: 1 : 1</p>	<p>DATE: OCT 2020</p>

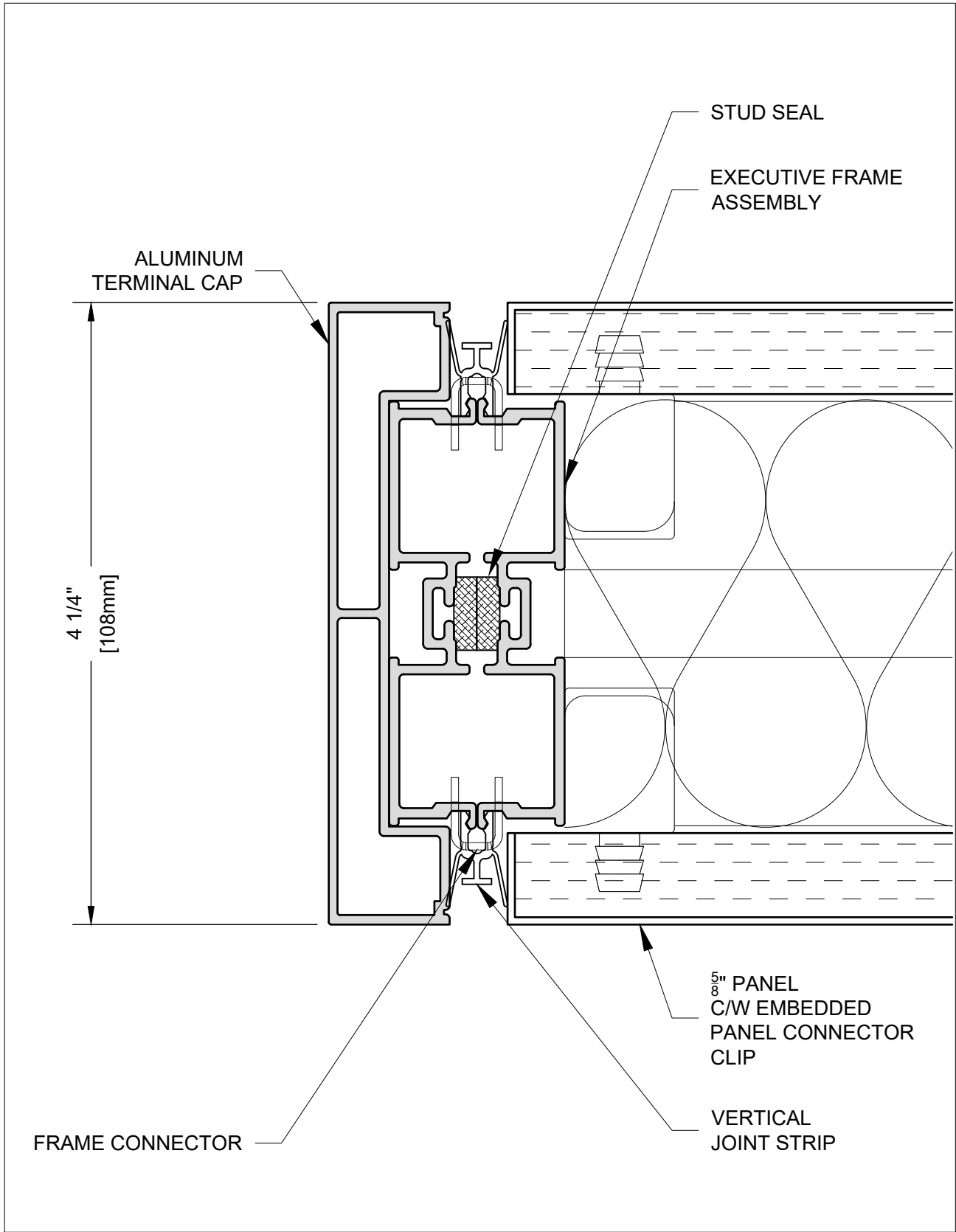

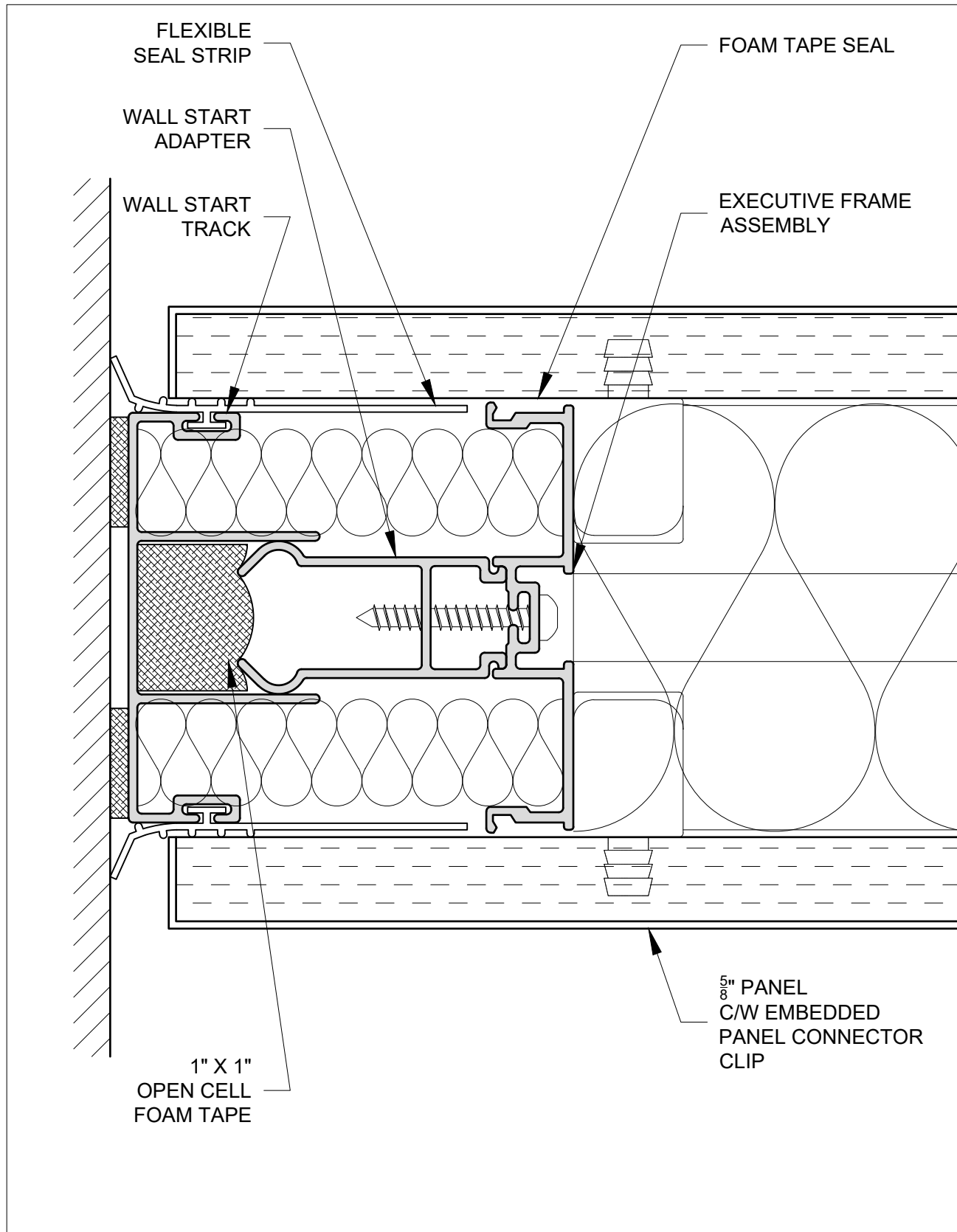

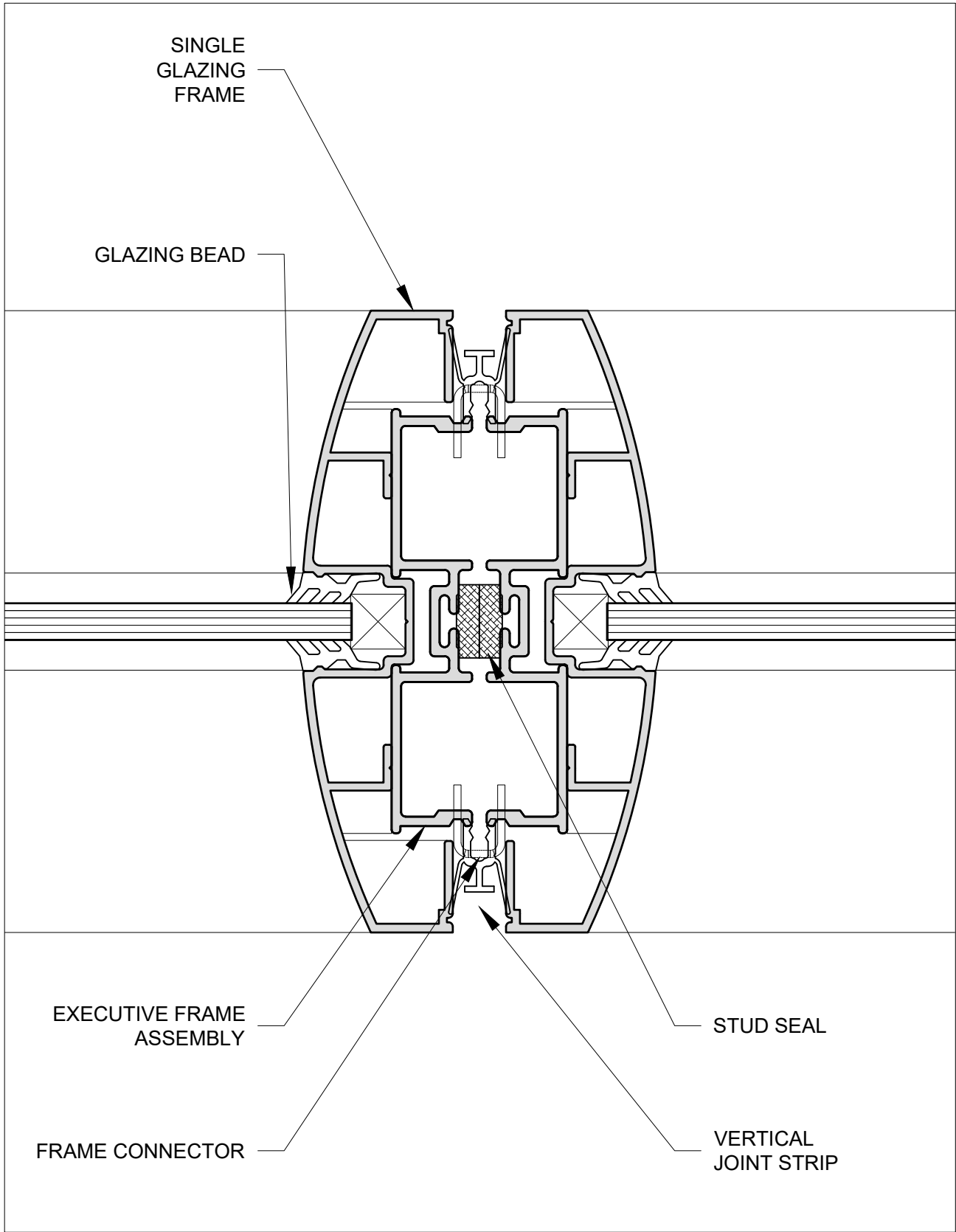

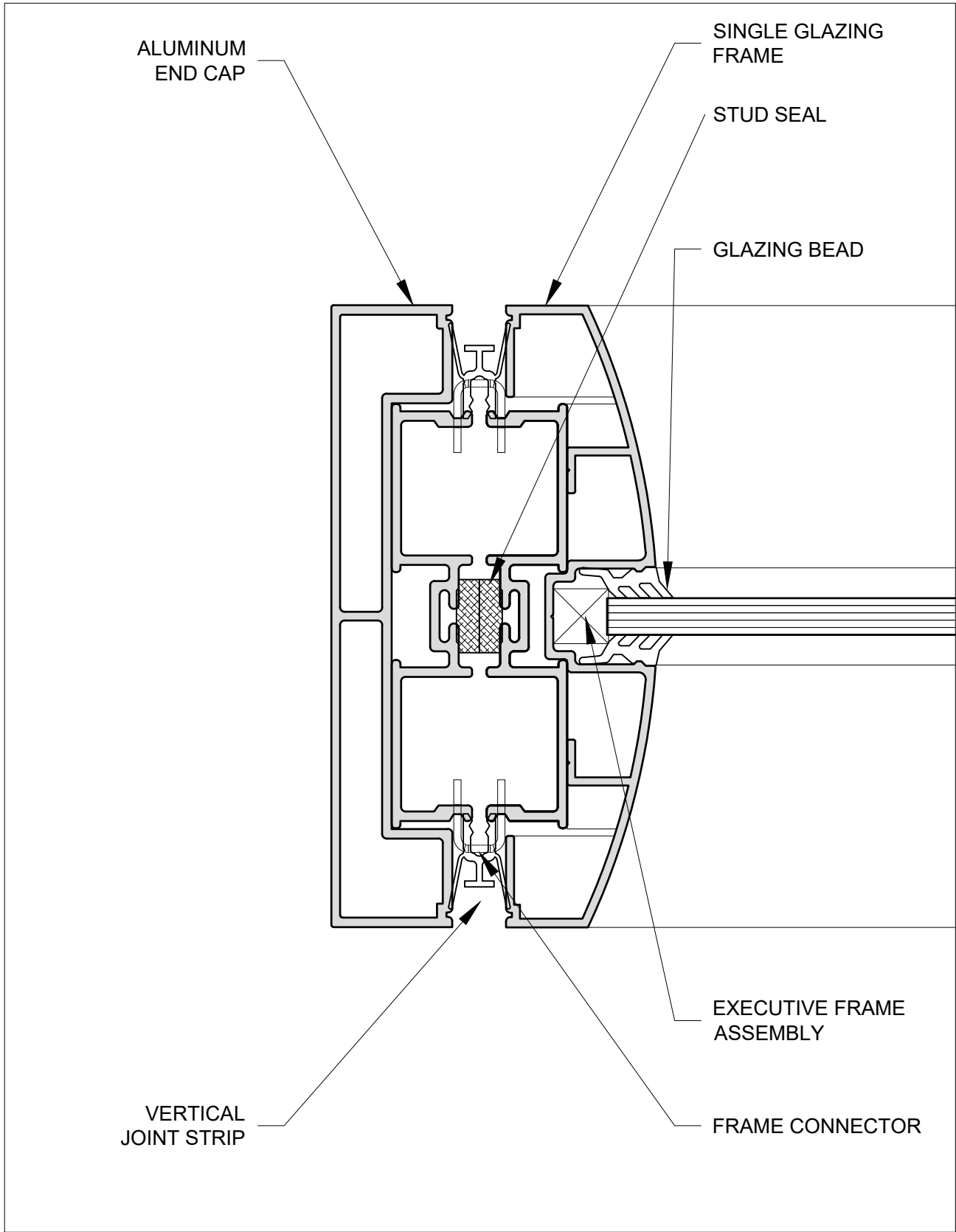

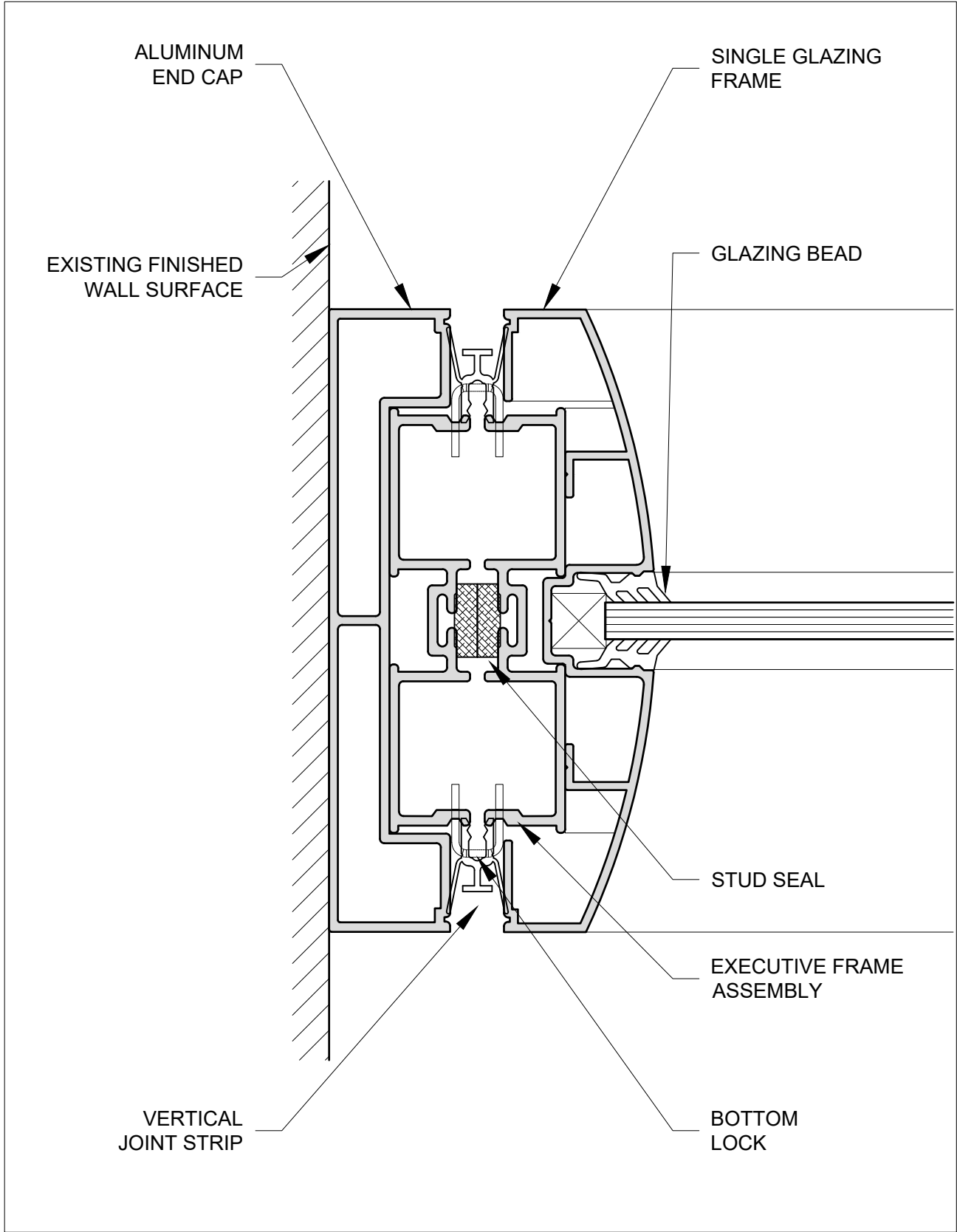



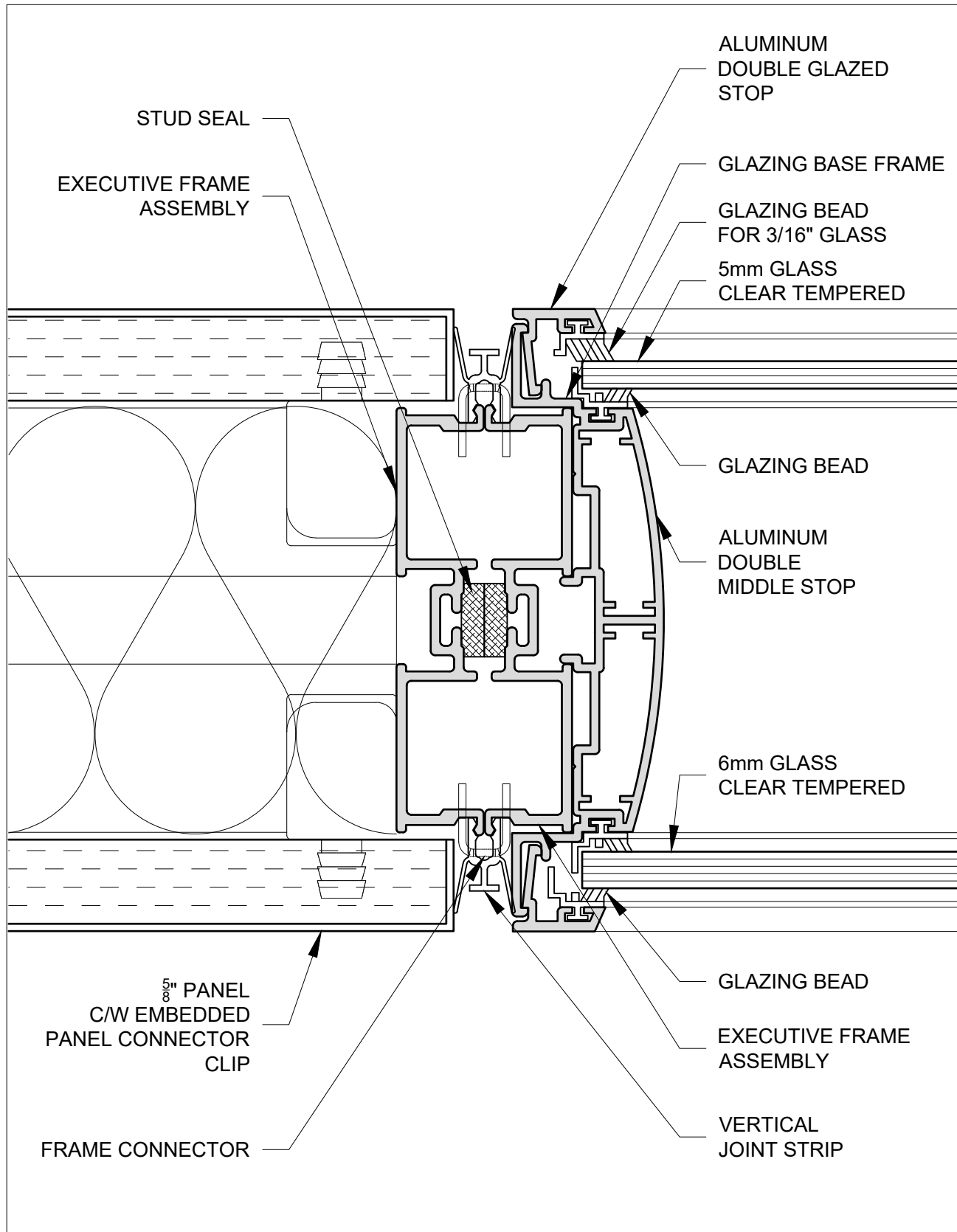

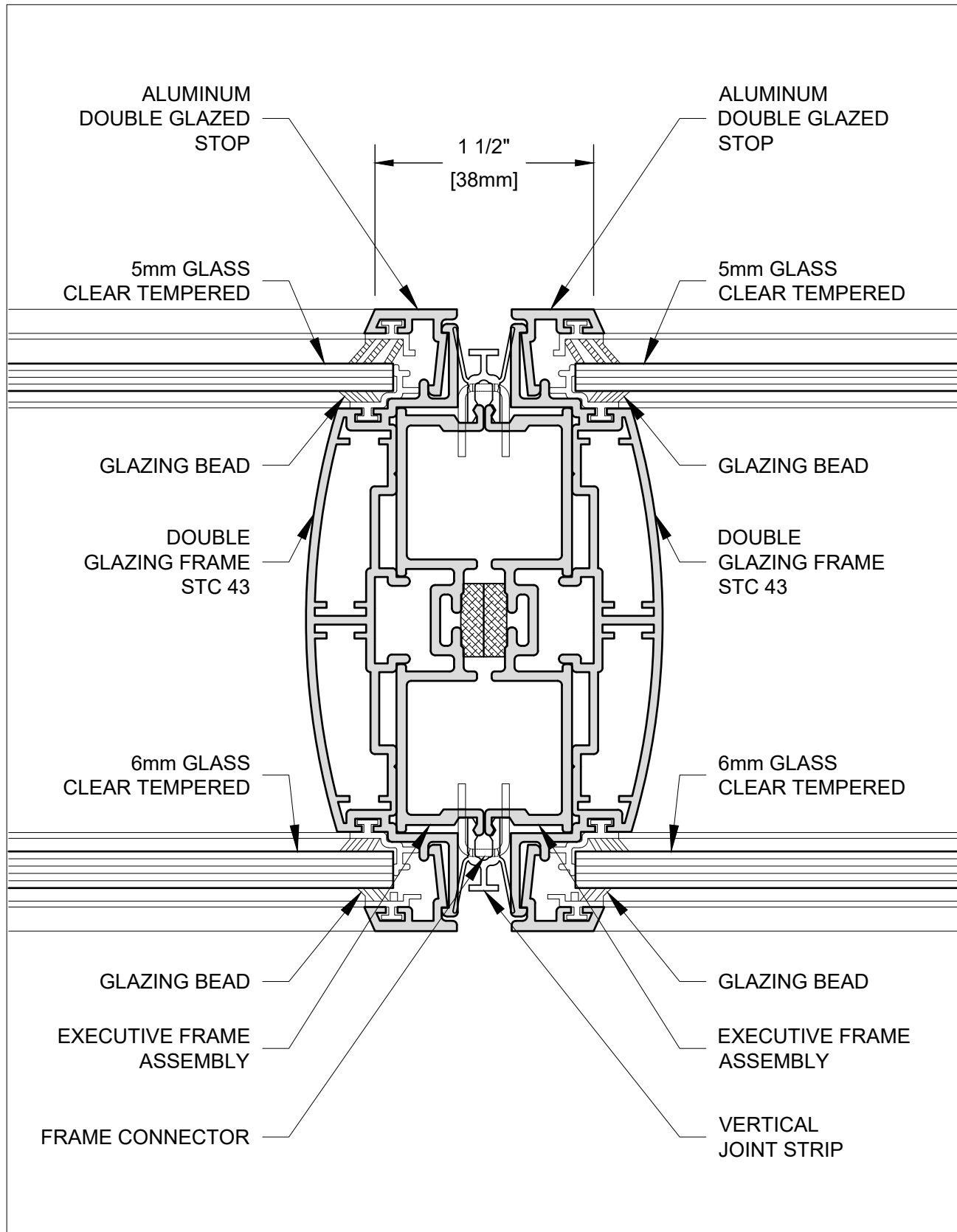

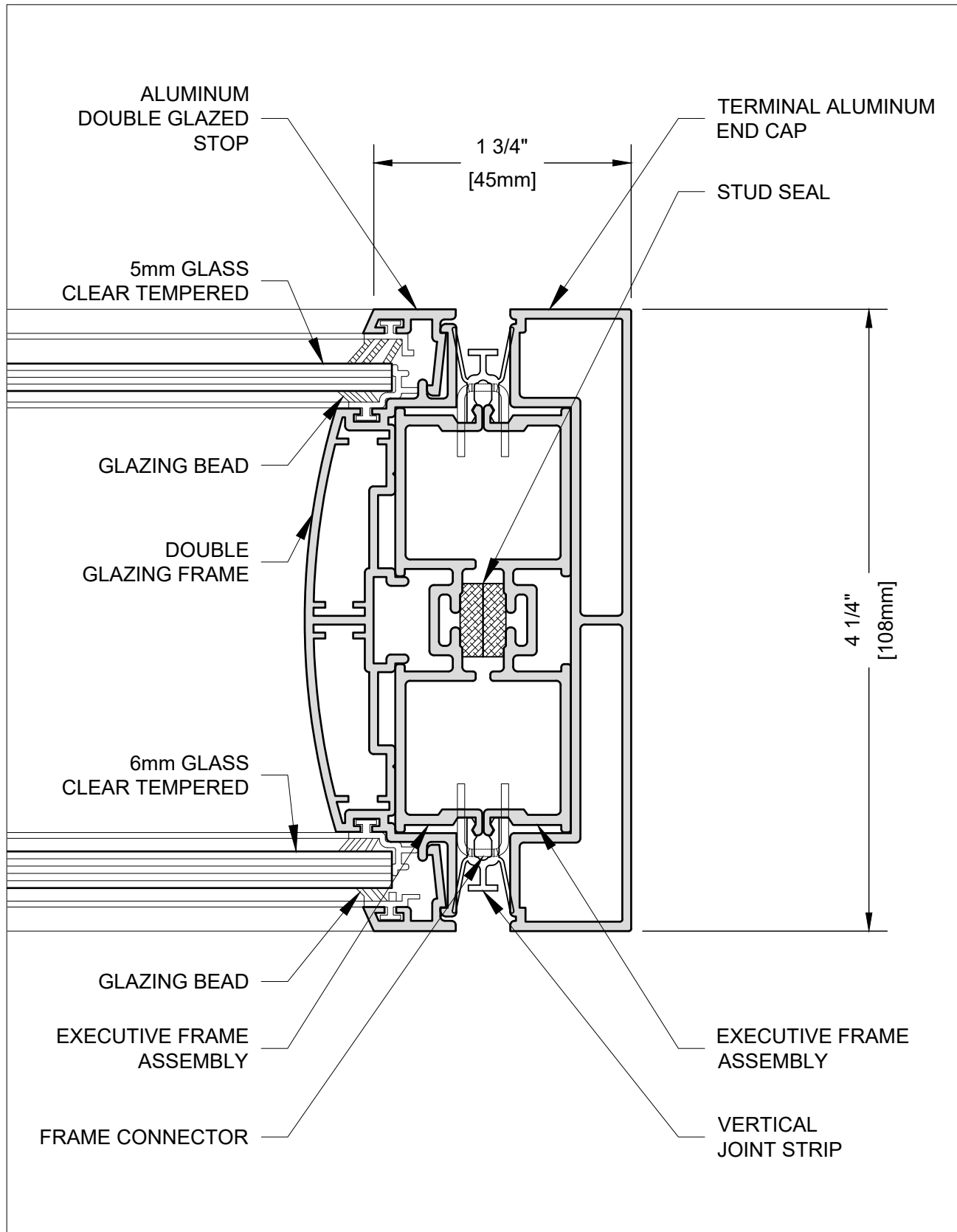

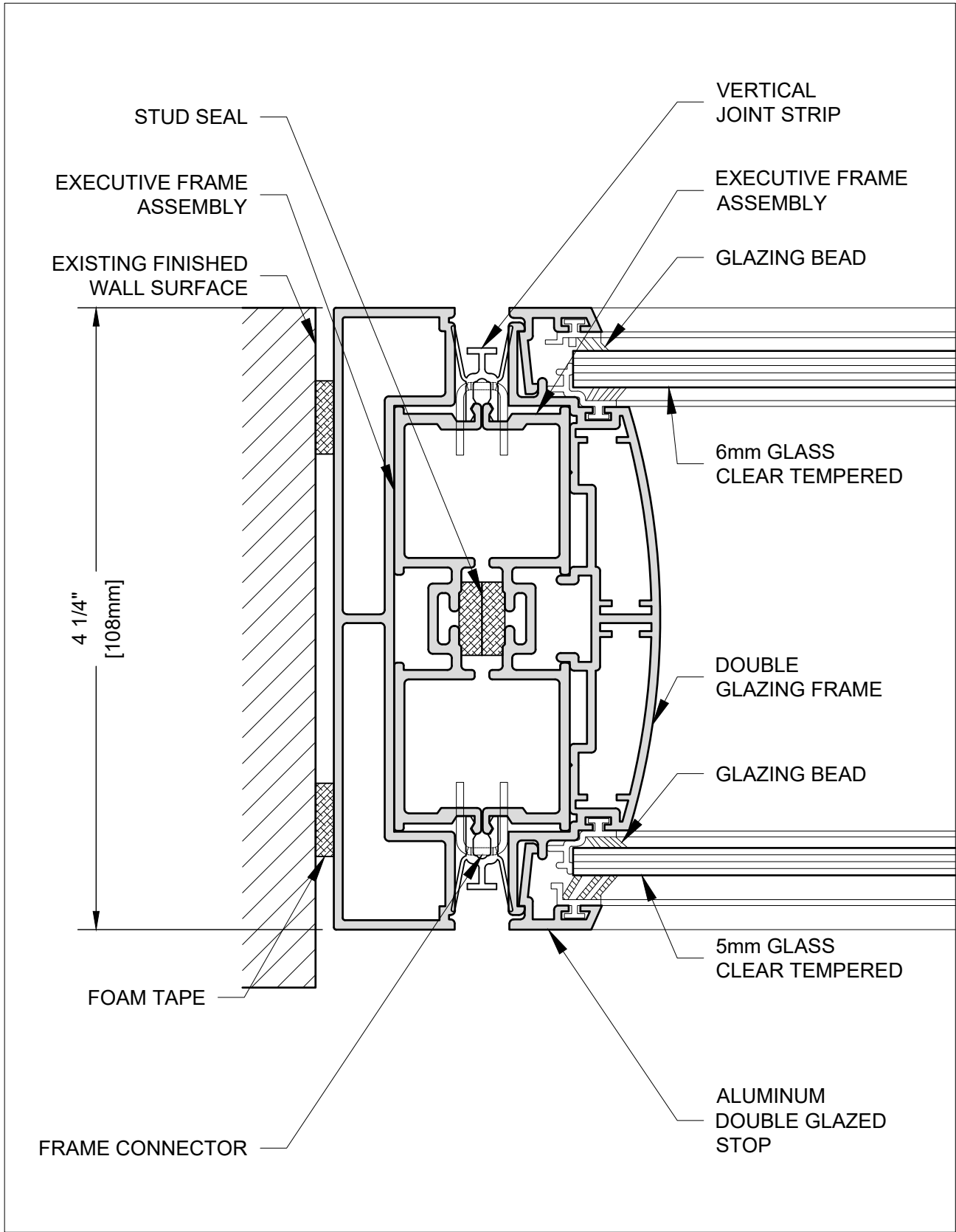

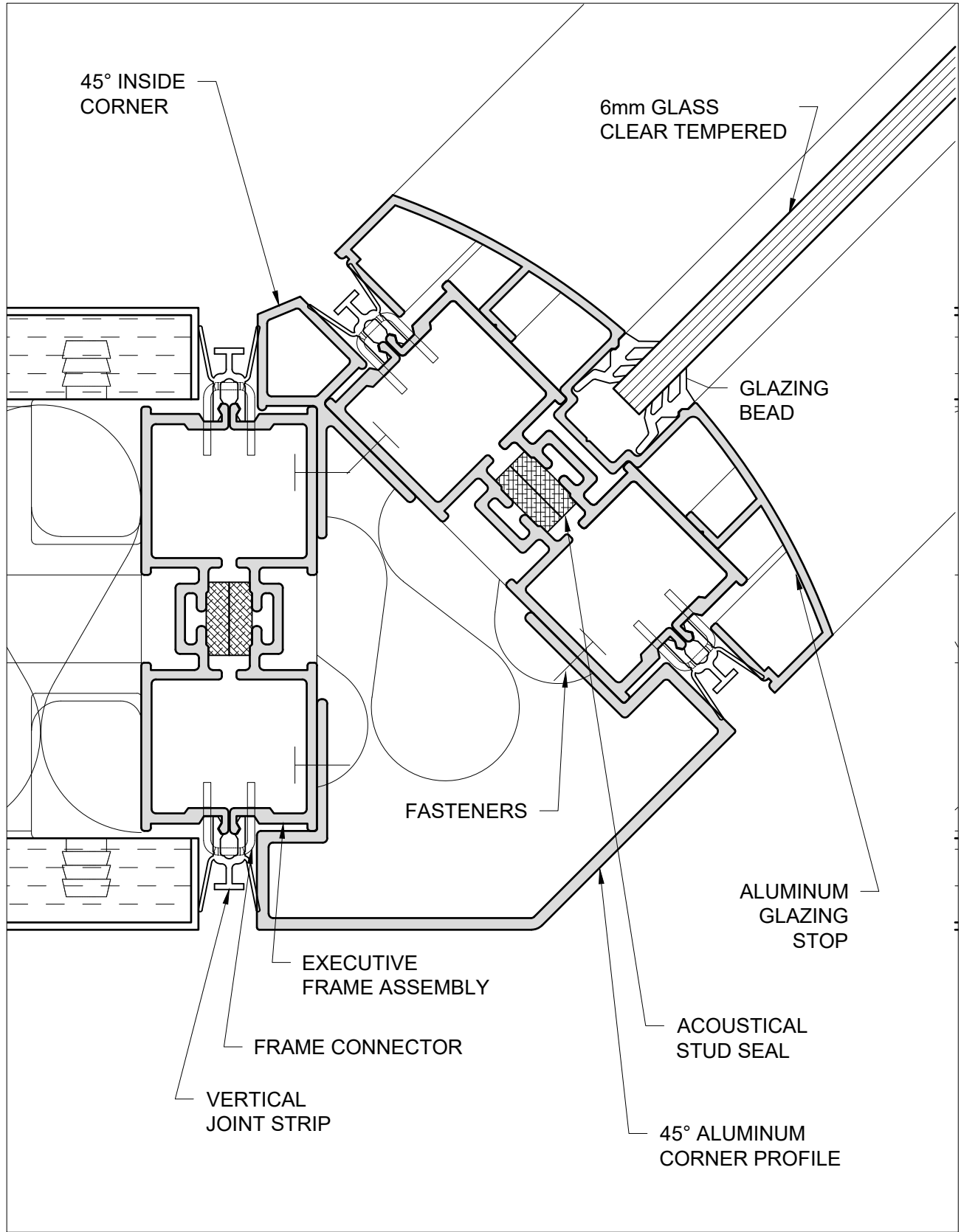

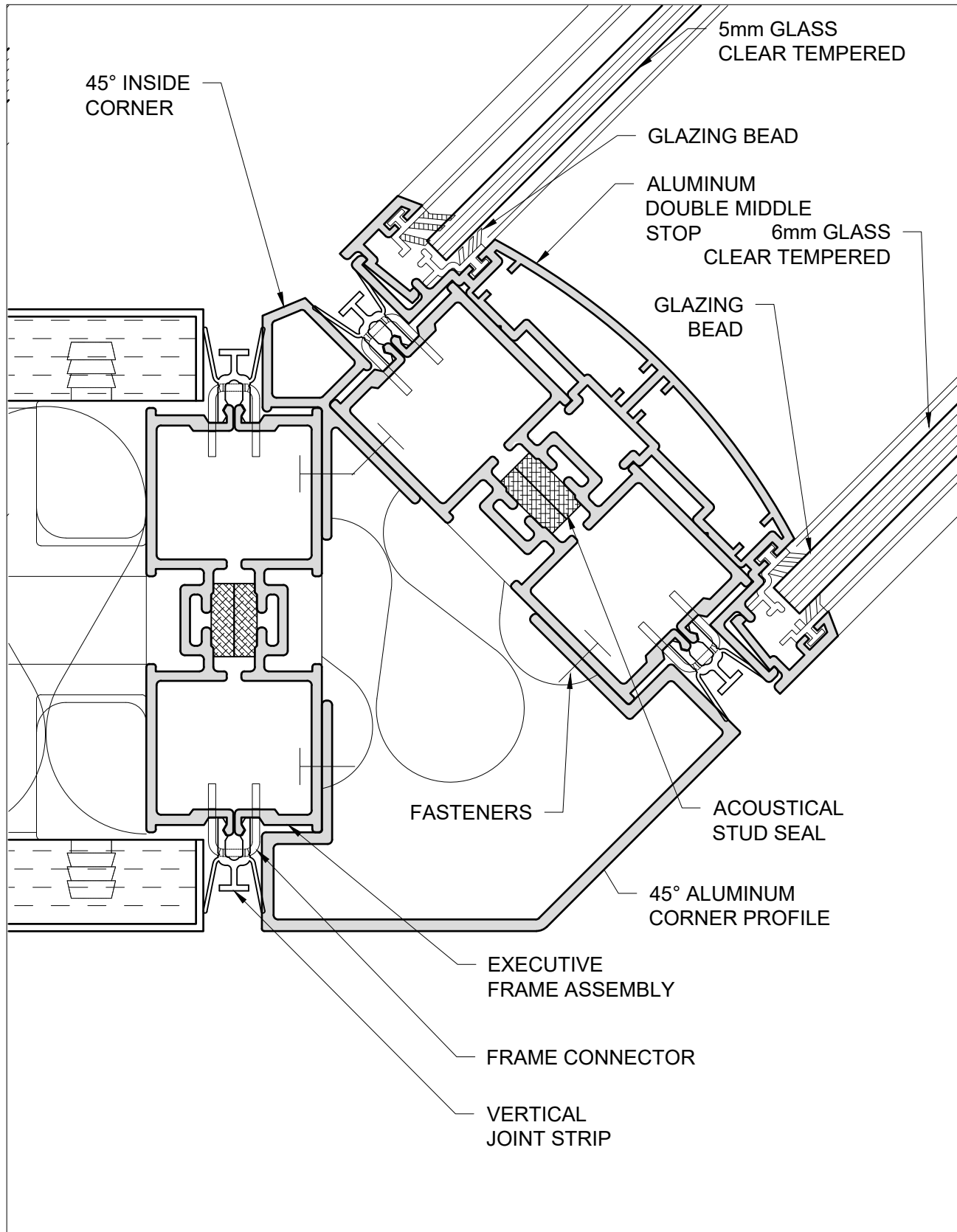

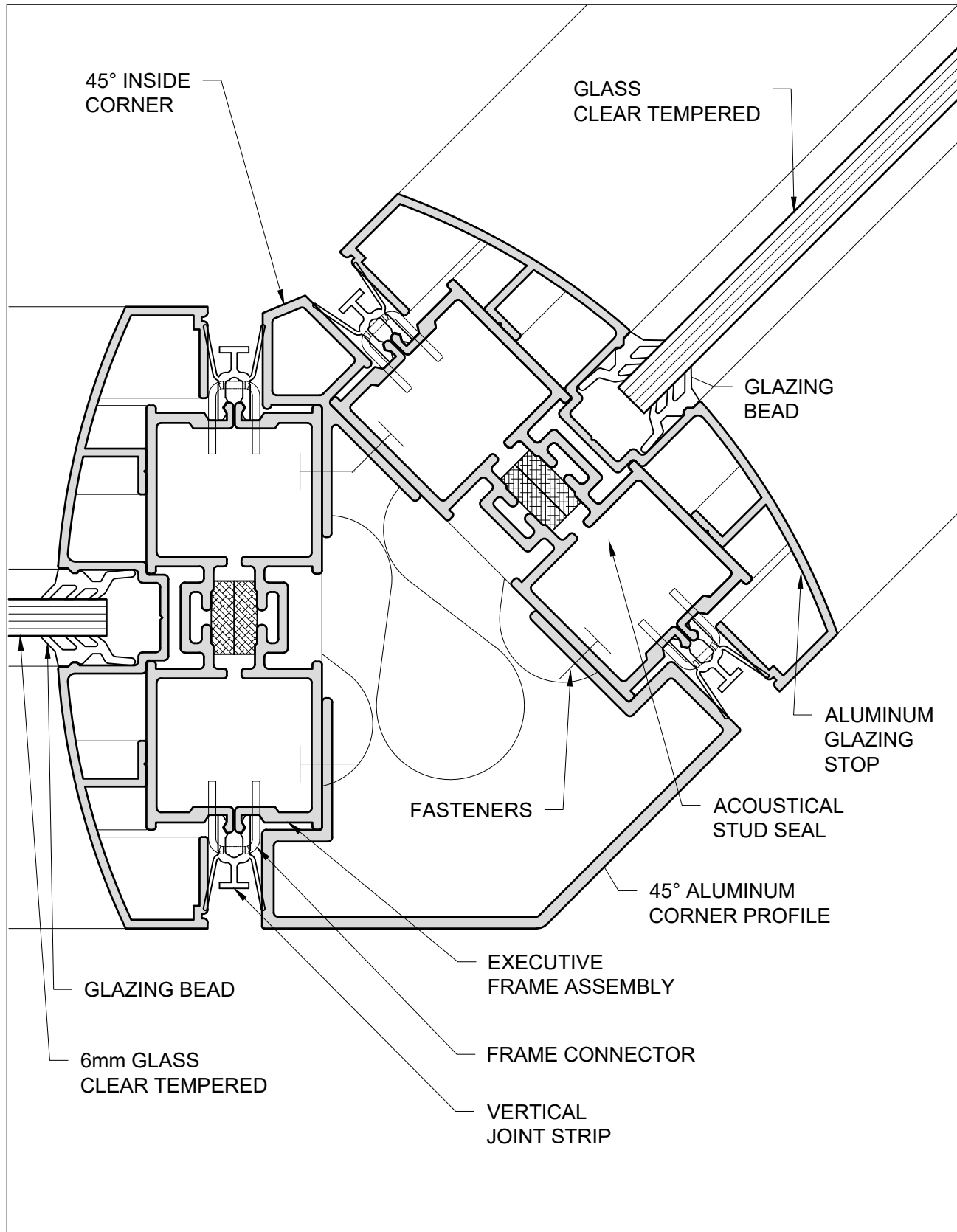

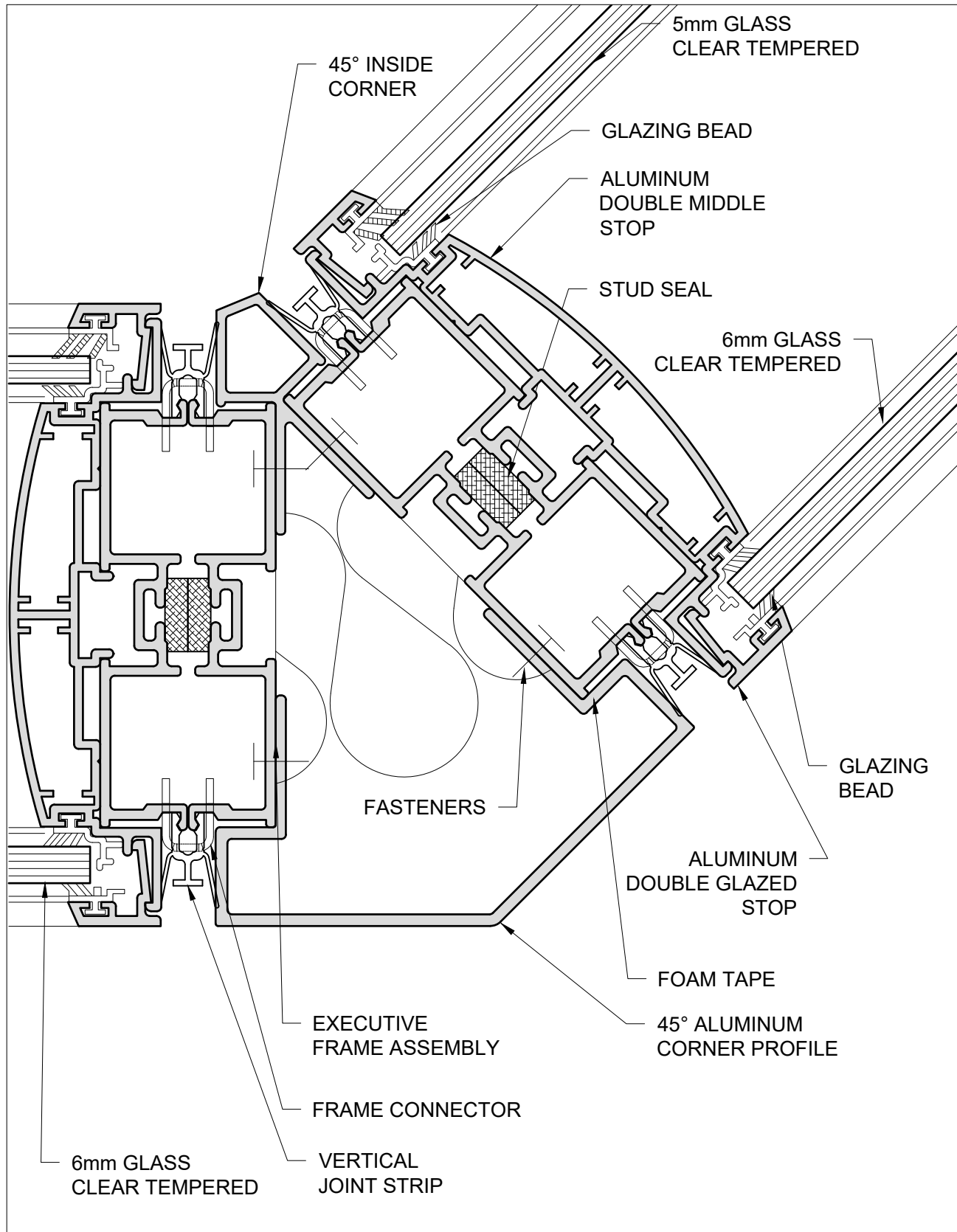



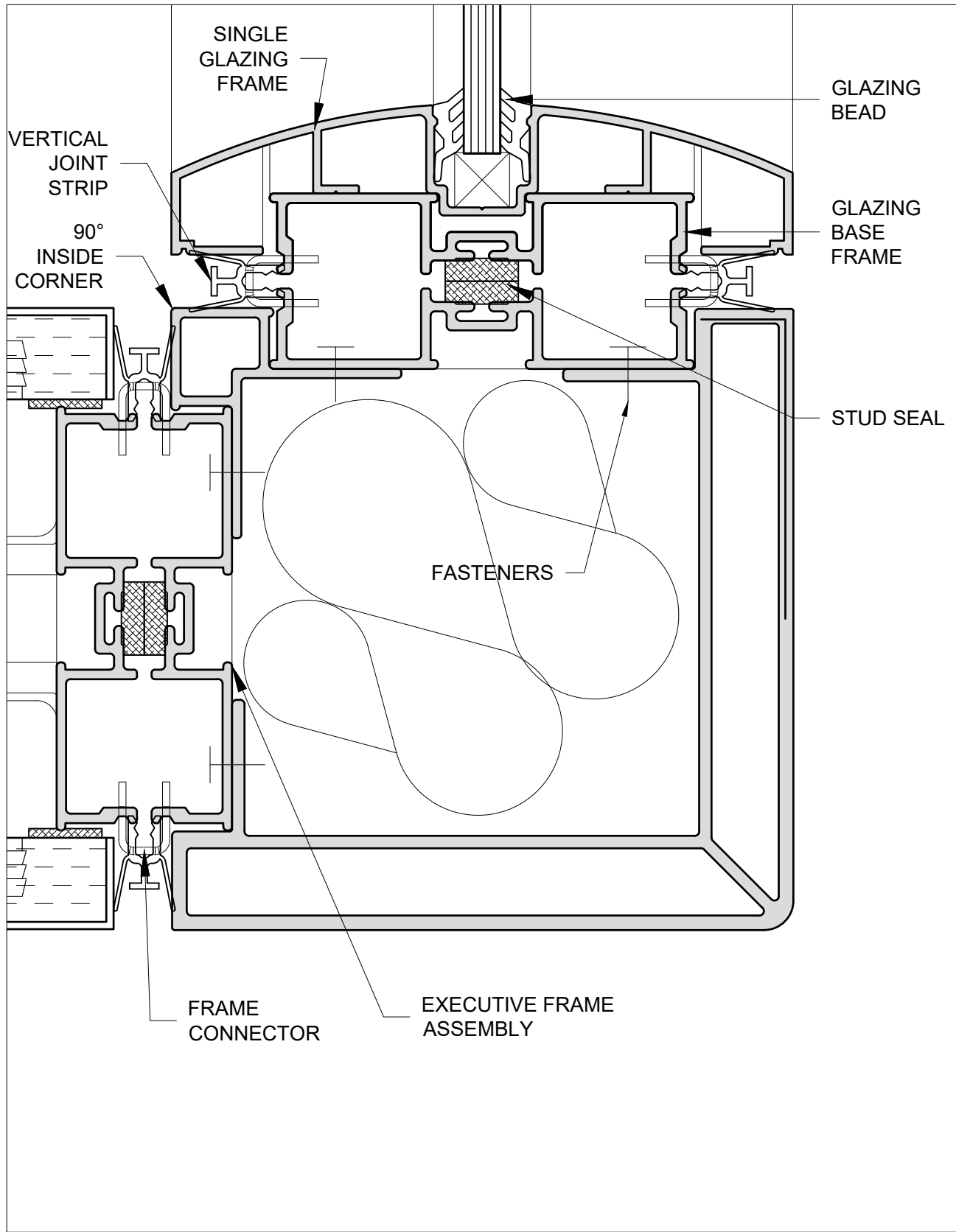

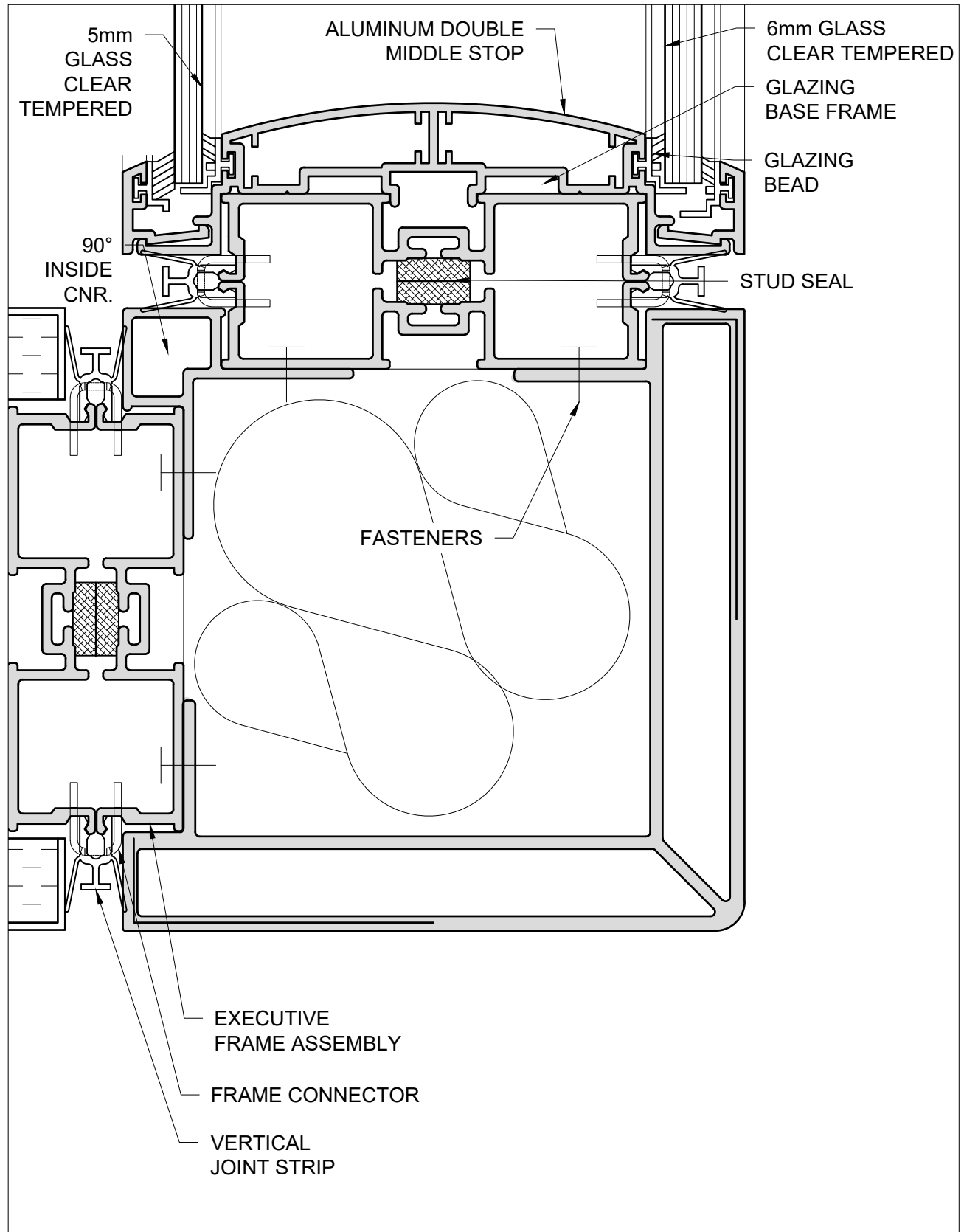

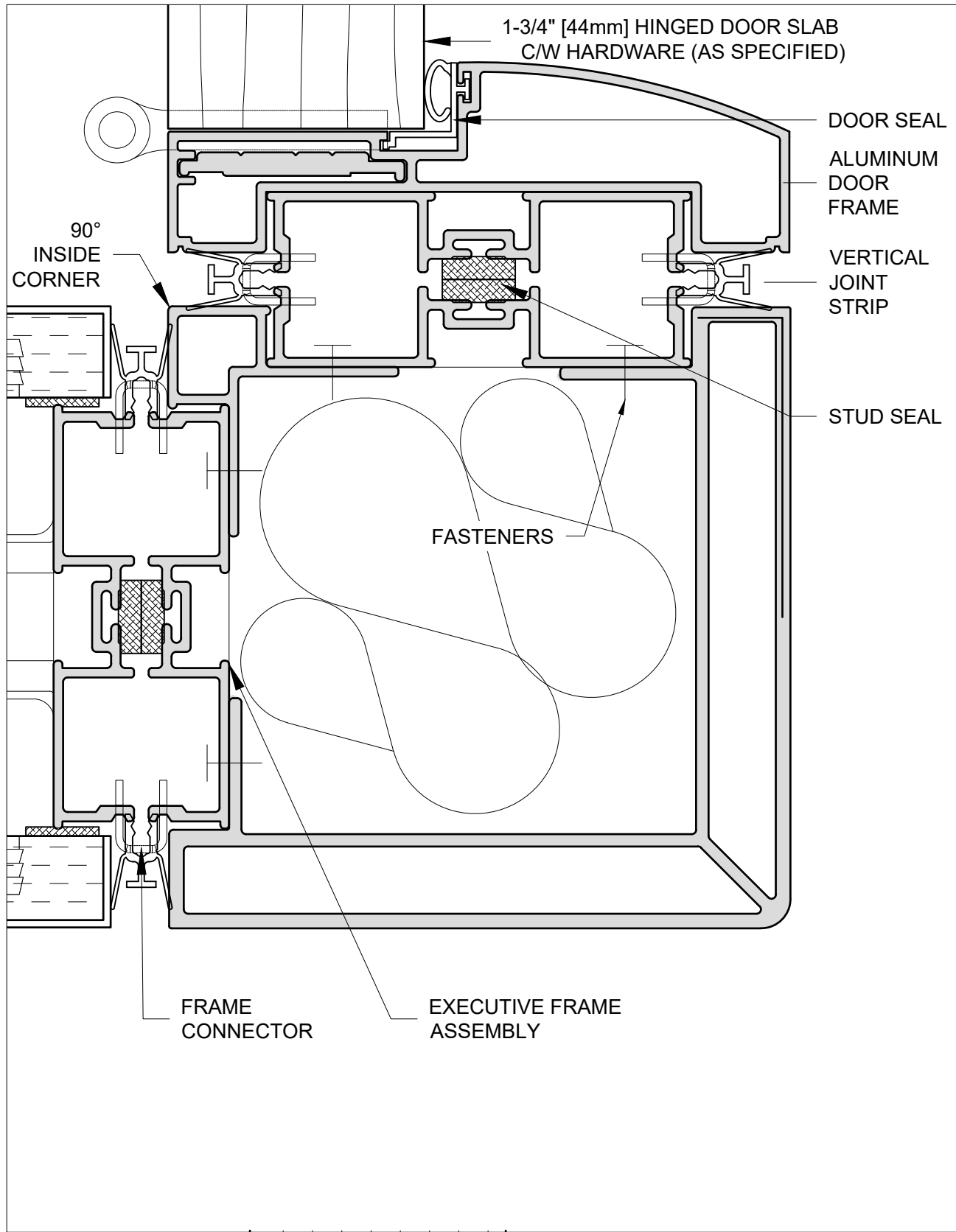

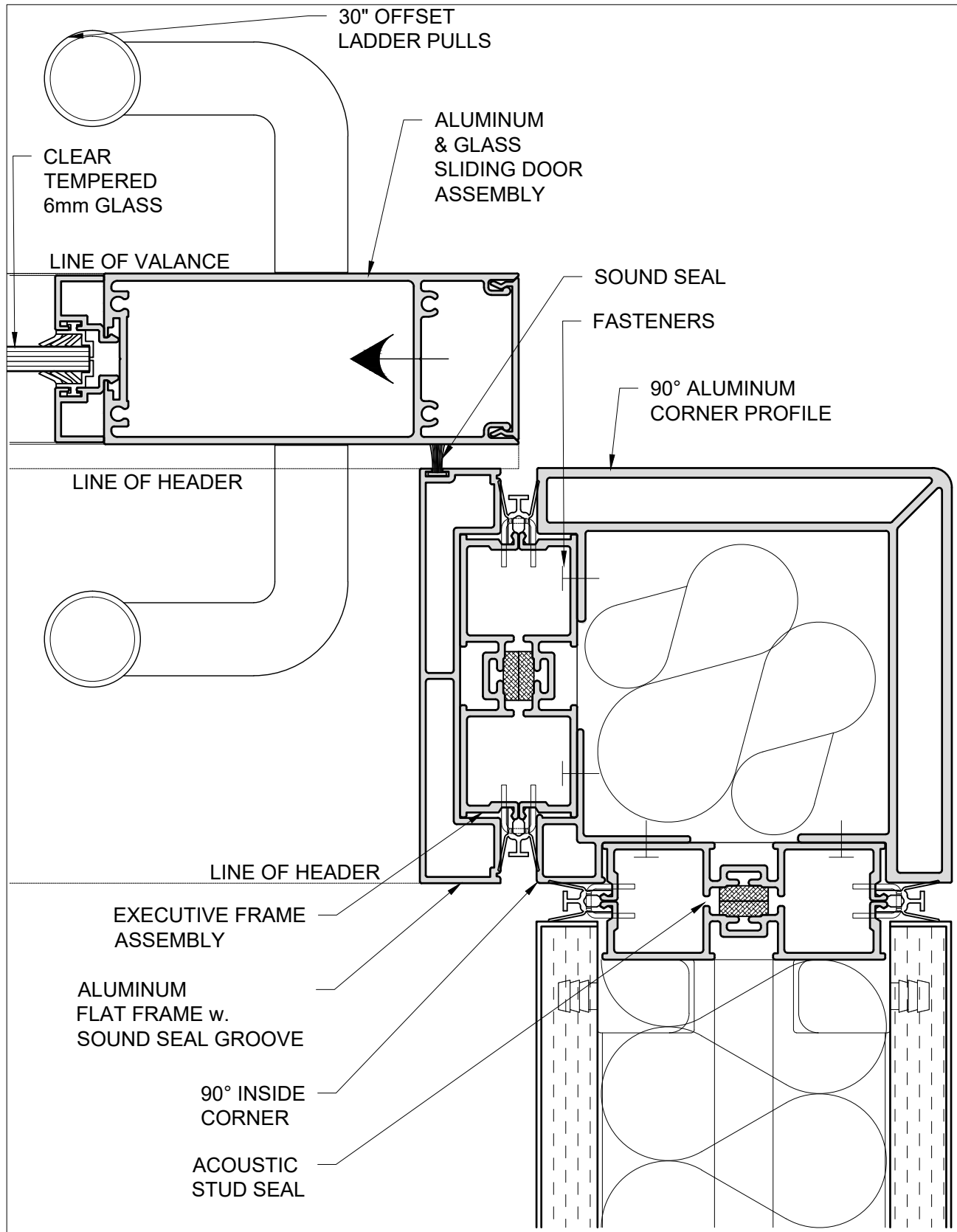

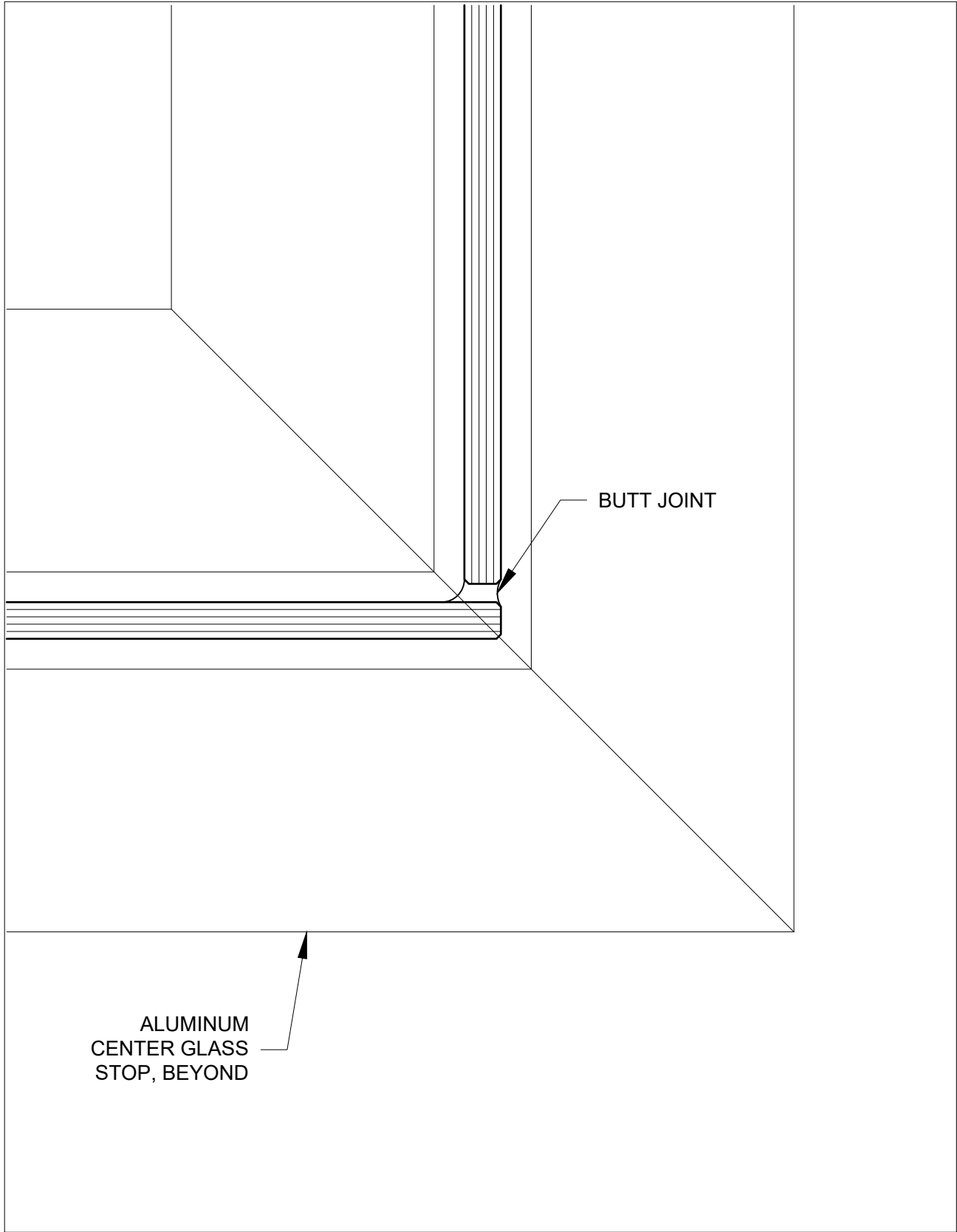

BUTT JOINT

ALUMINUM  
CENTER GLASS  
STOP, BEYOND



**SINGLE-SINGLE GLAZING  
90° CORNER**

DWG:

**2.5.2.2**

FILE:

SCALE: 1 : 1

DATE: OCT 2020

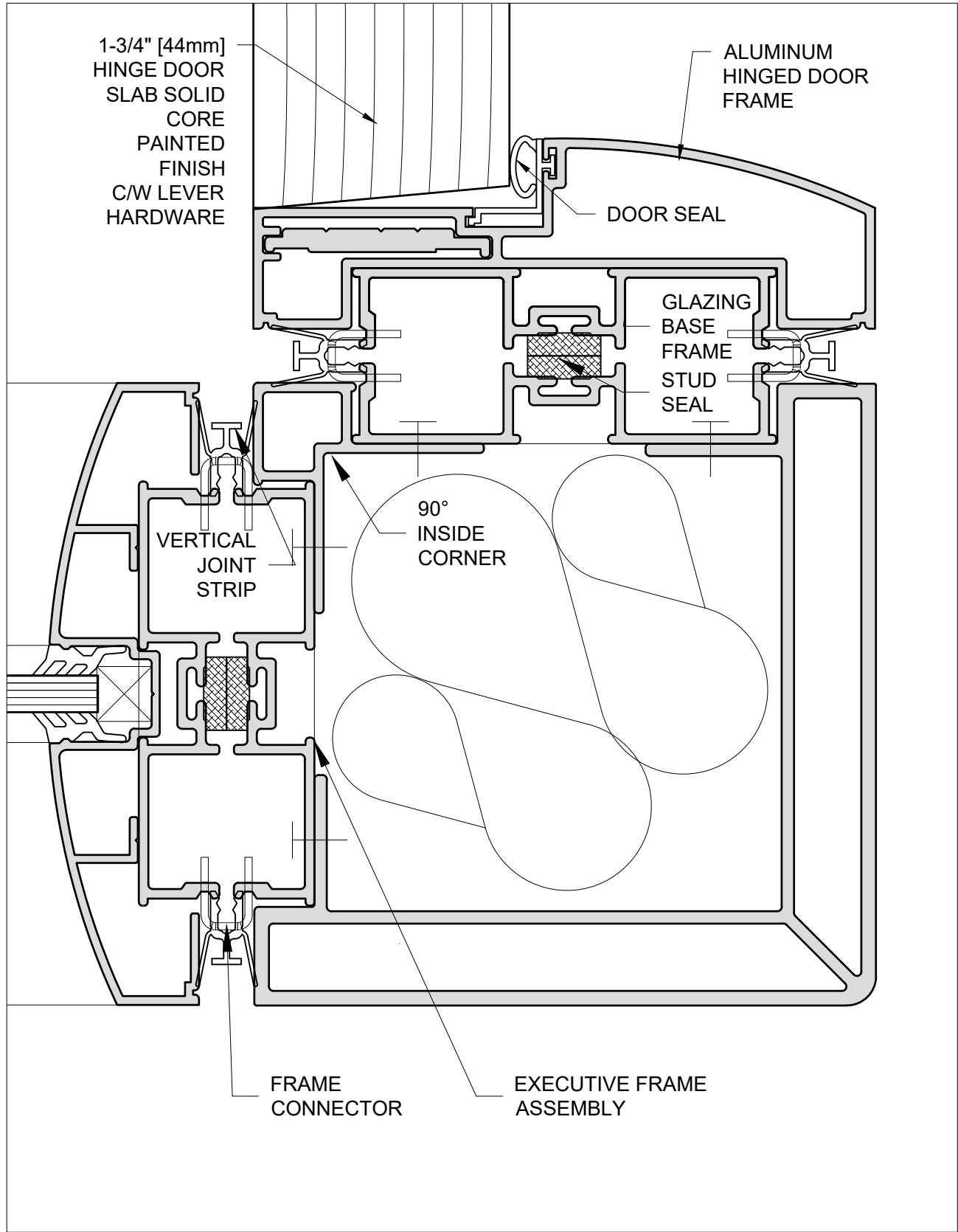

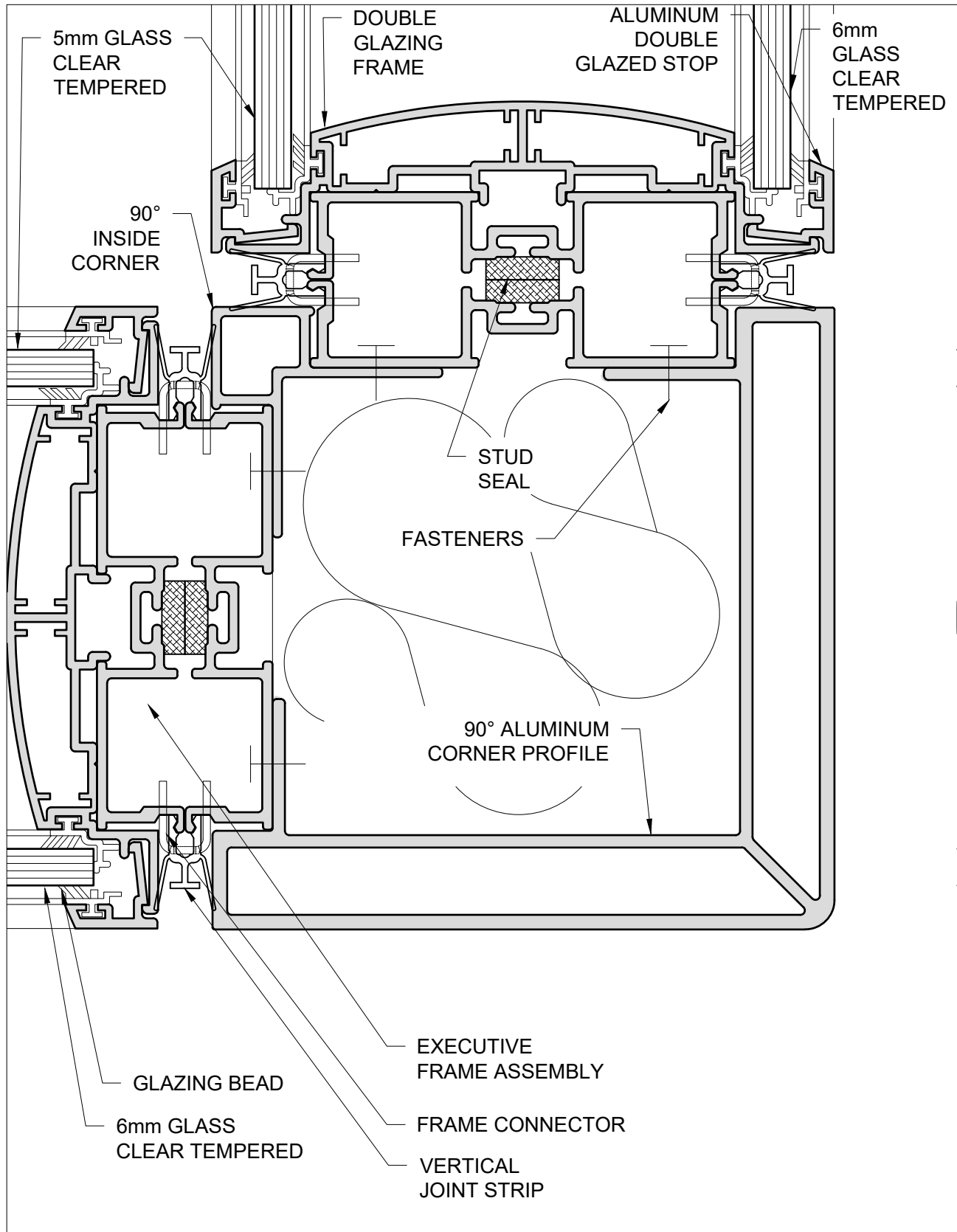

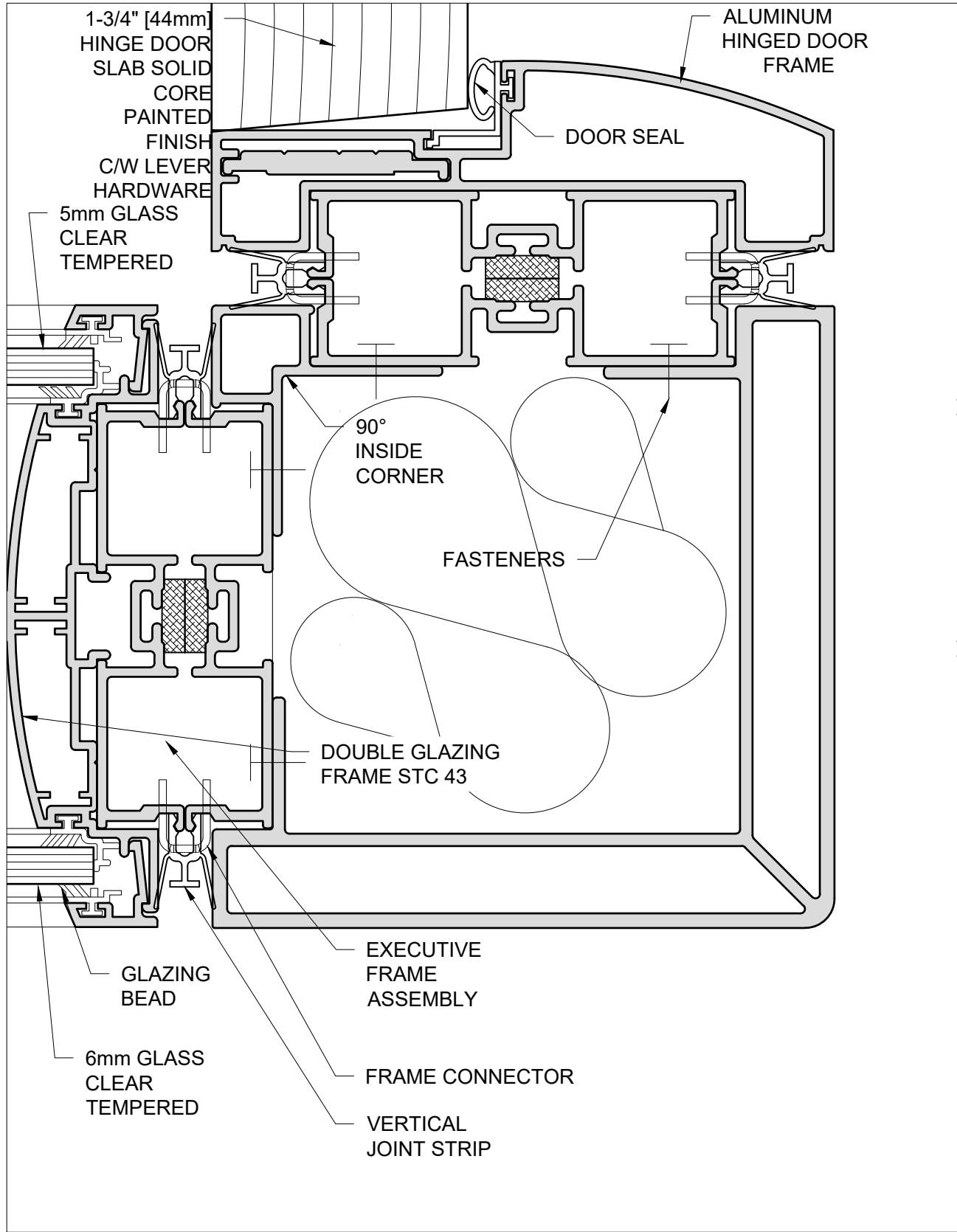



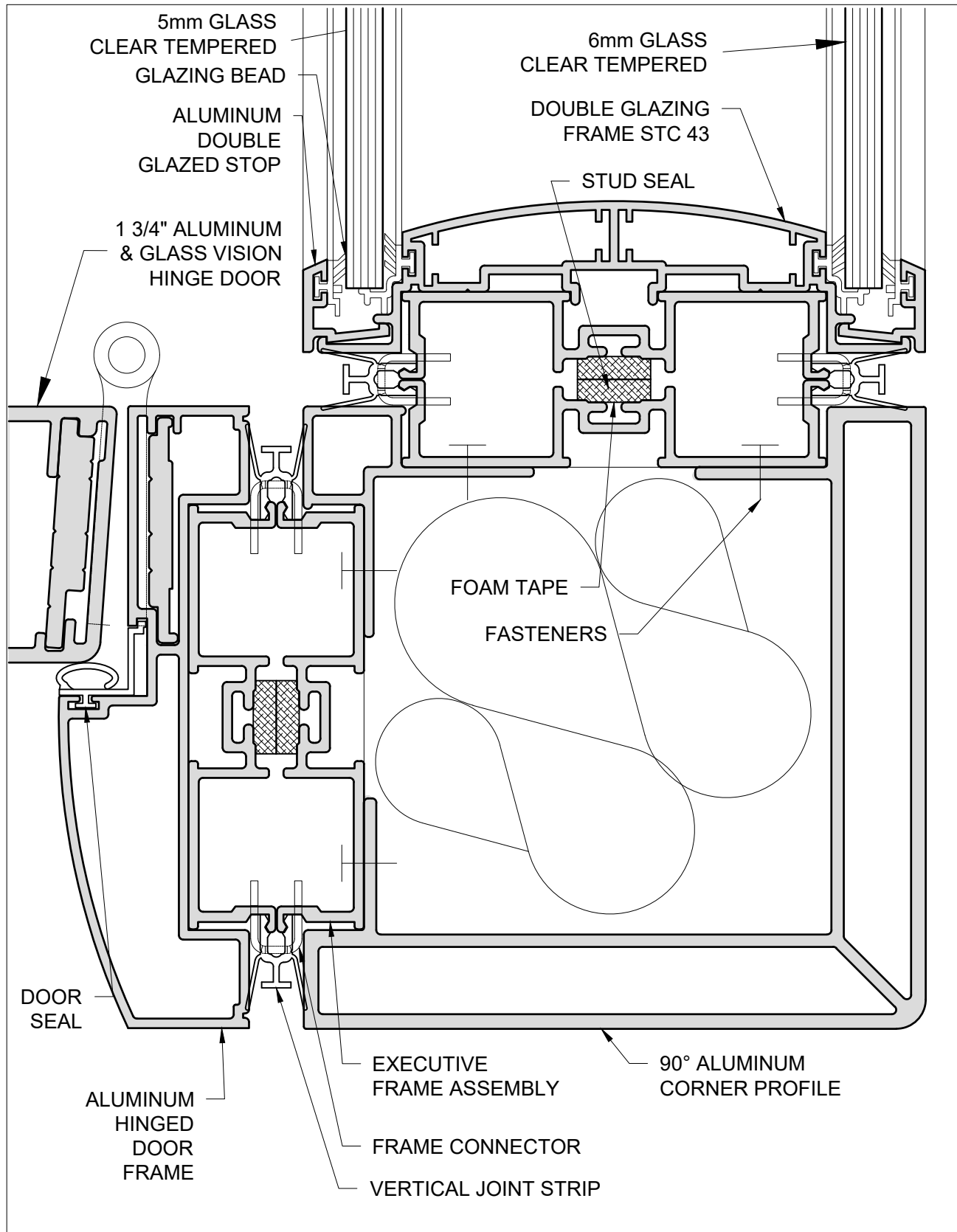

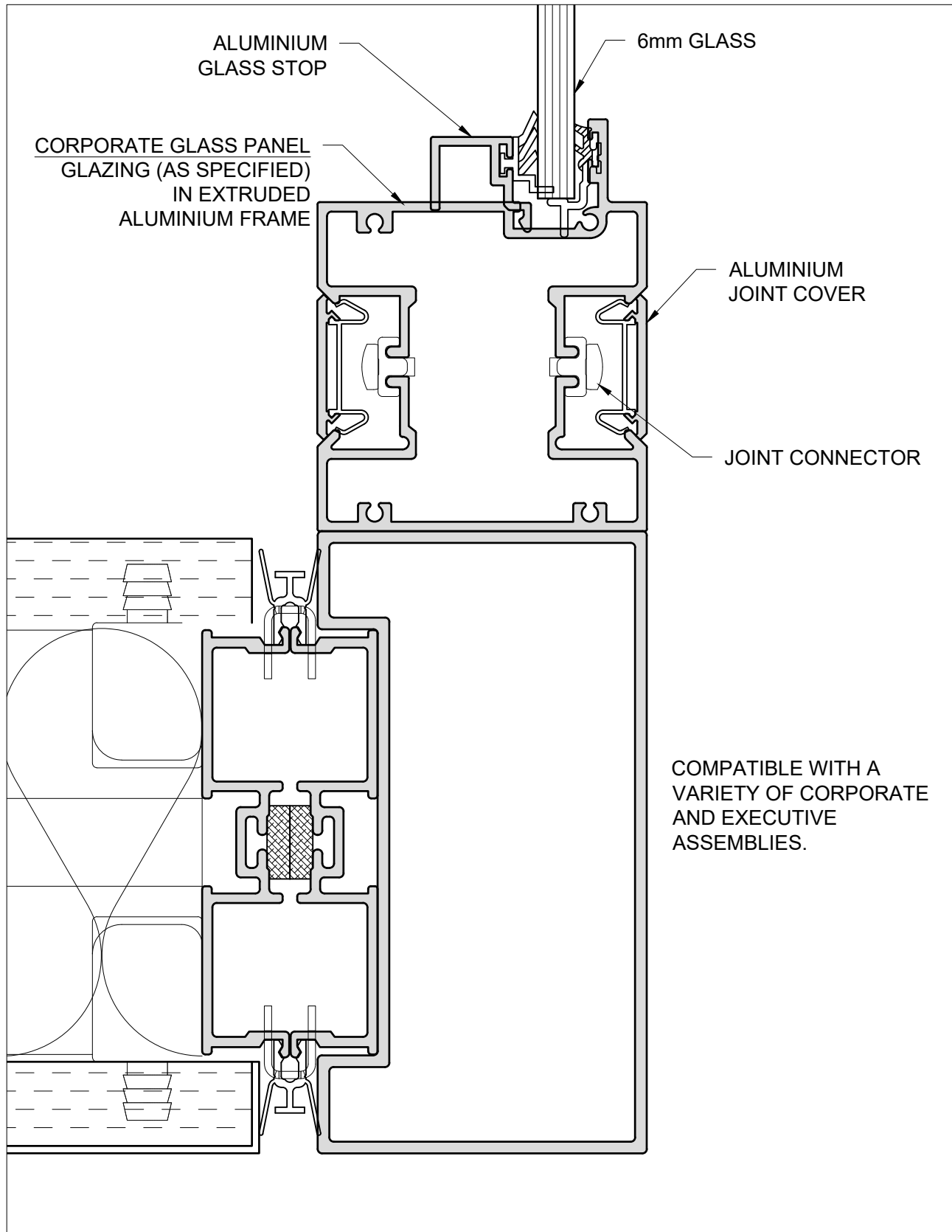

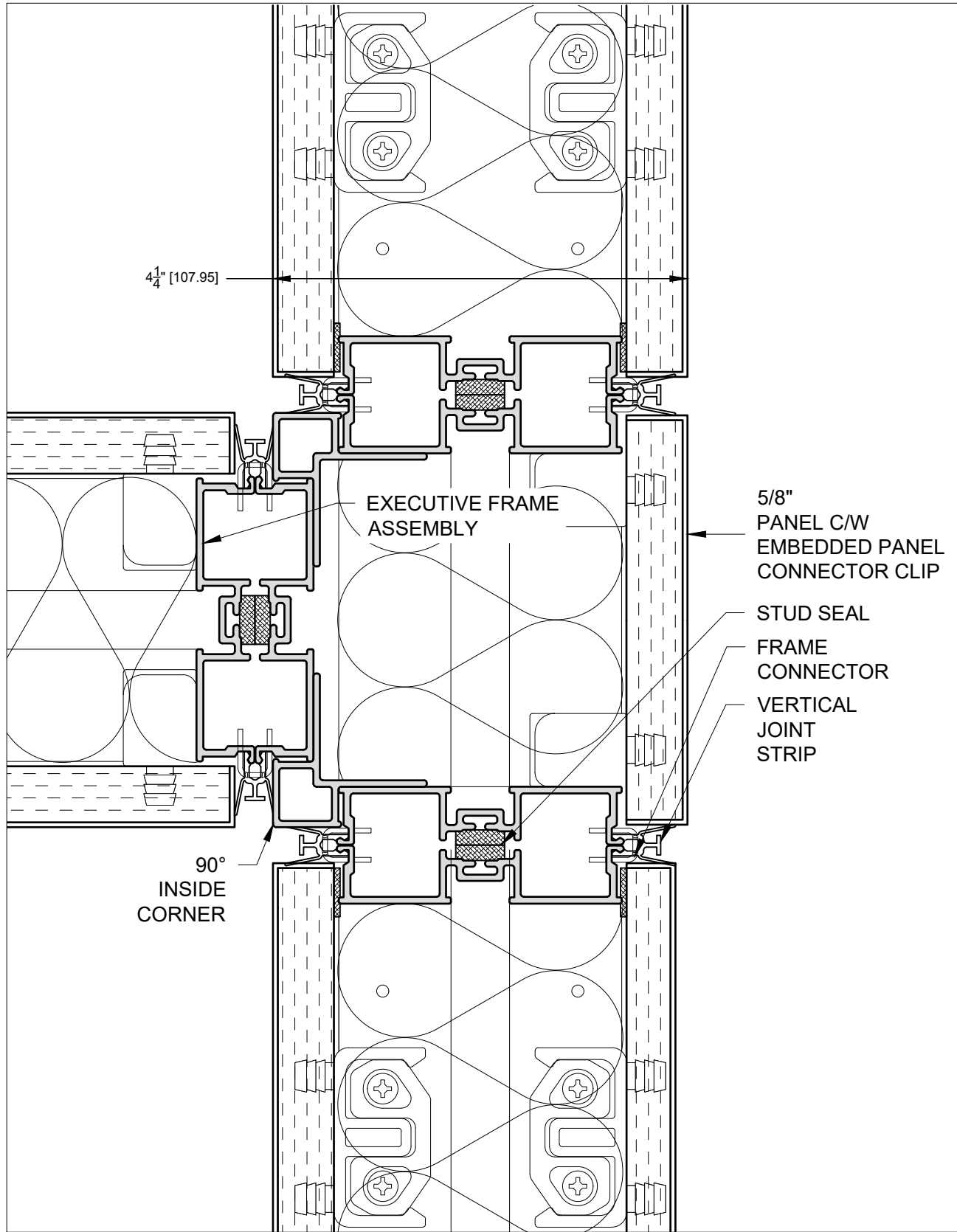

4 1/4" [107.95]

EXECUTIVE FRAME ASSEMBLY

5/8" PANEL C/W EMBEDDED PANEL CONNECTOR CLIP

STUD SEAL

FRAME CONNECTOR

VERTICAL JOINT STRIP

90° INSIDE CORNER

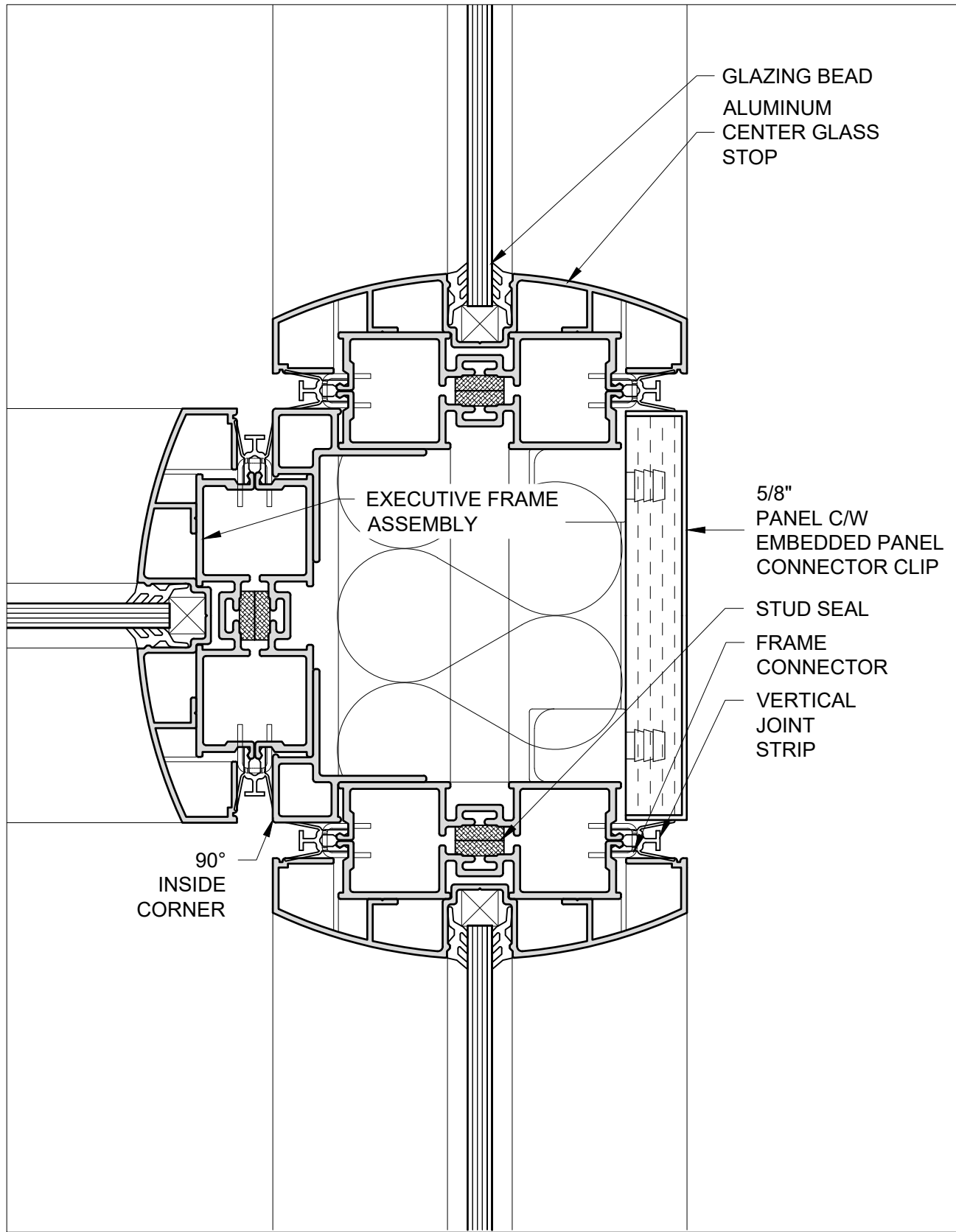

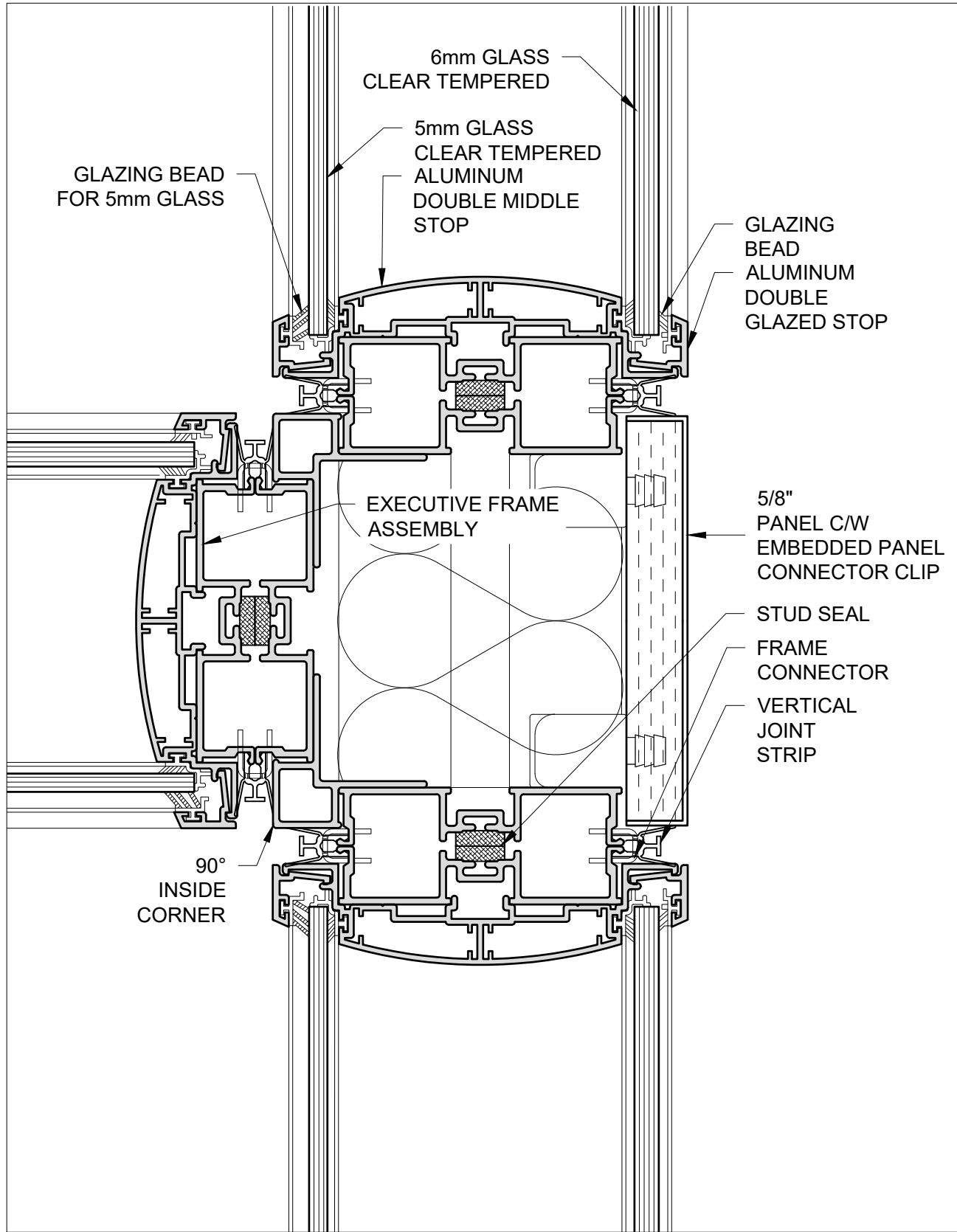

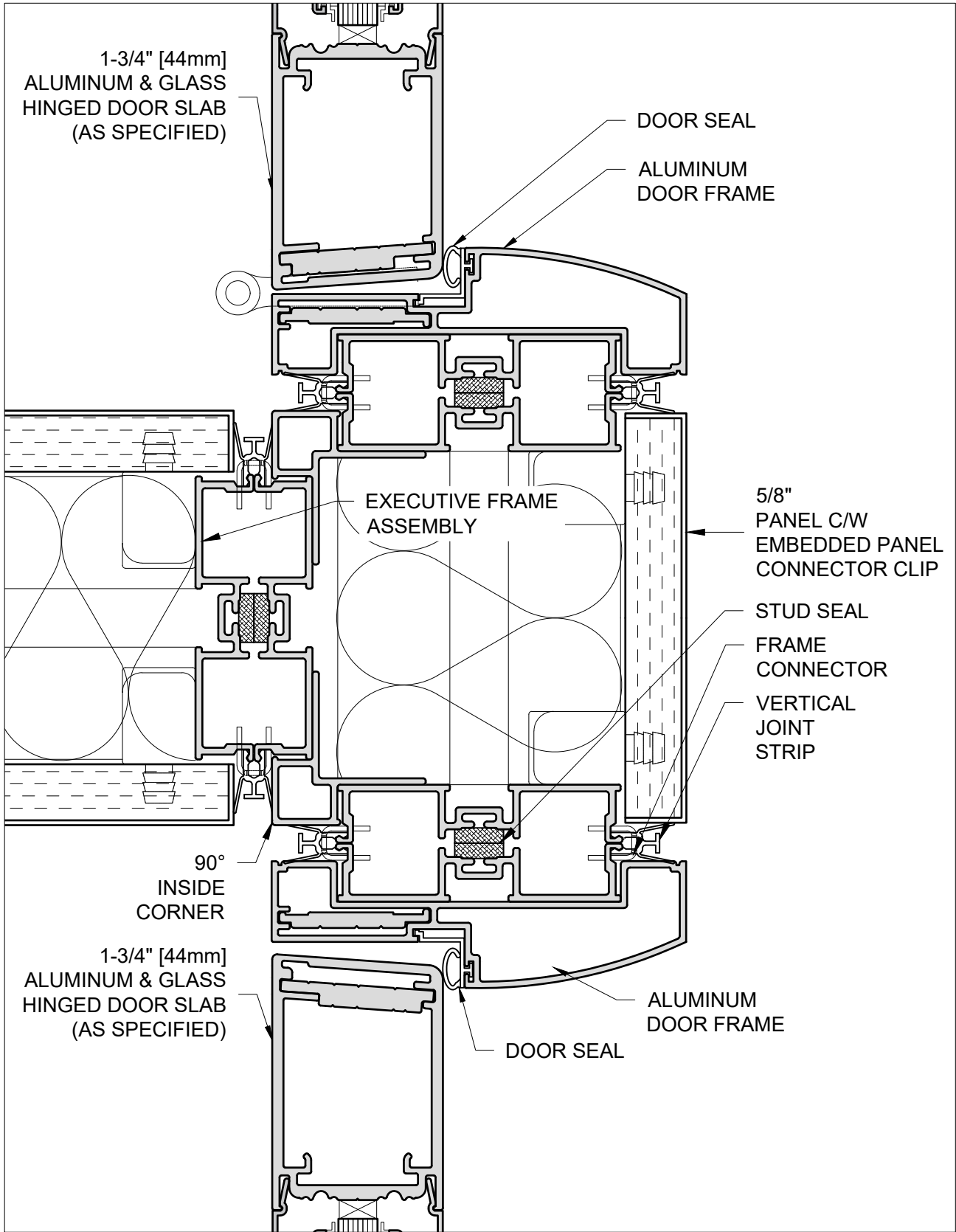

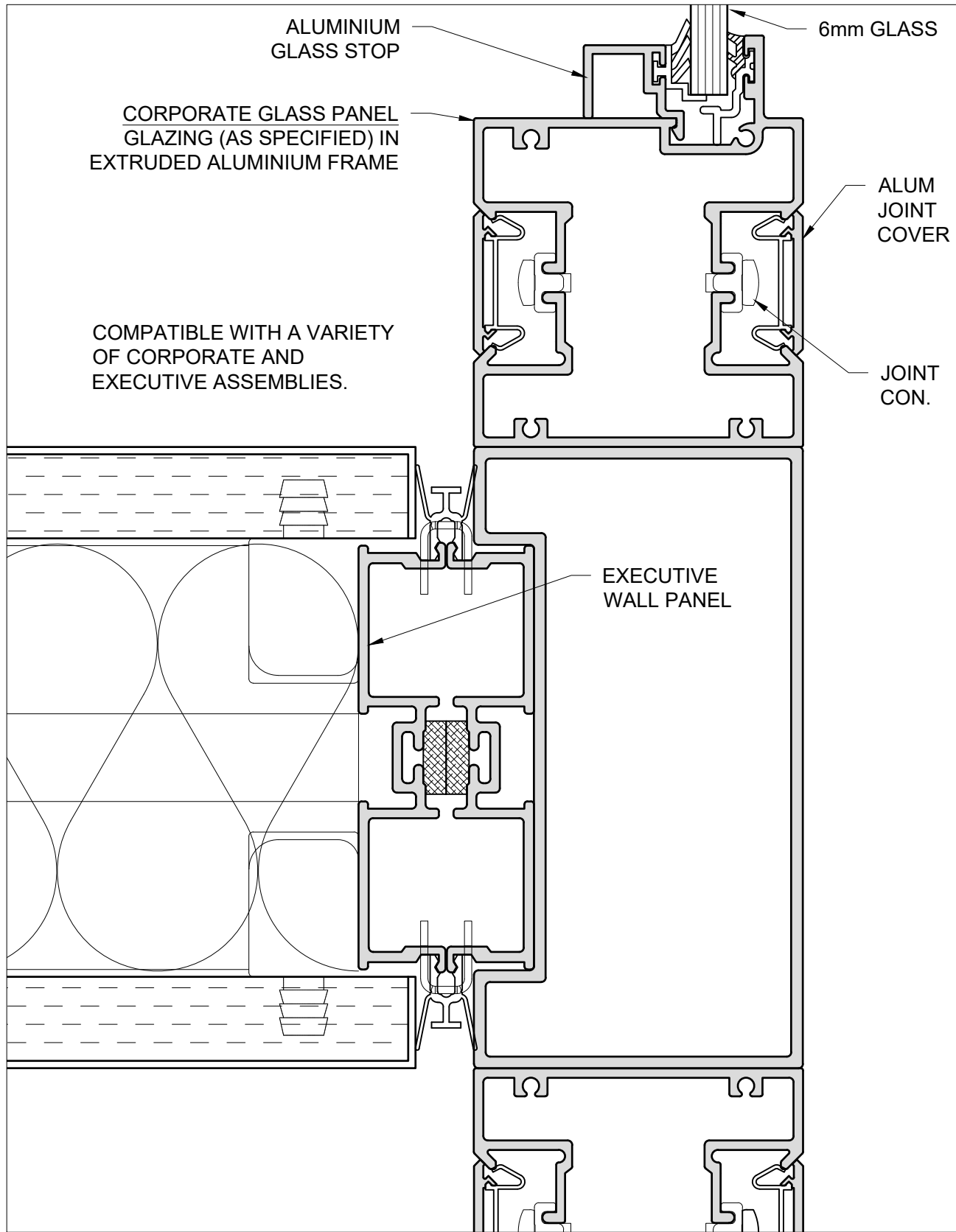

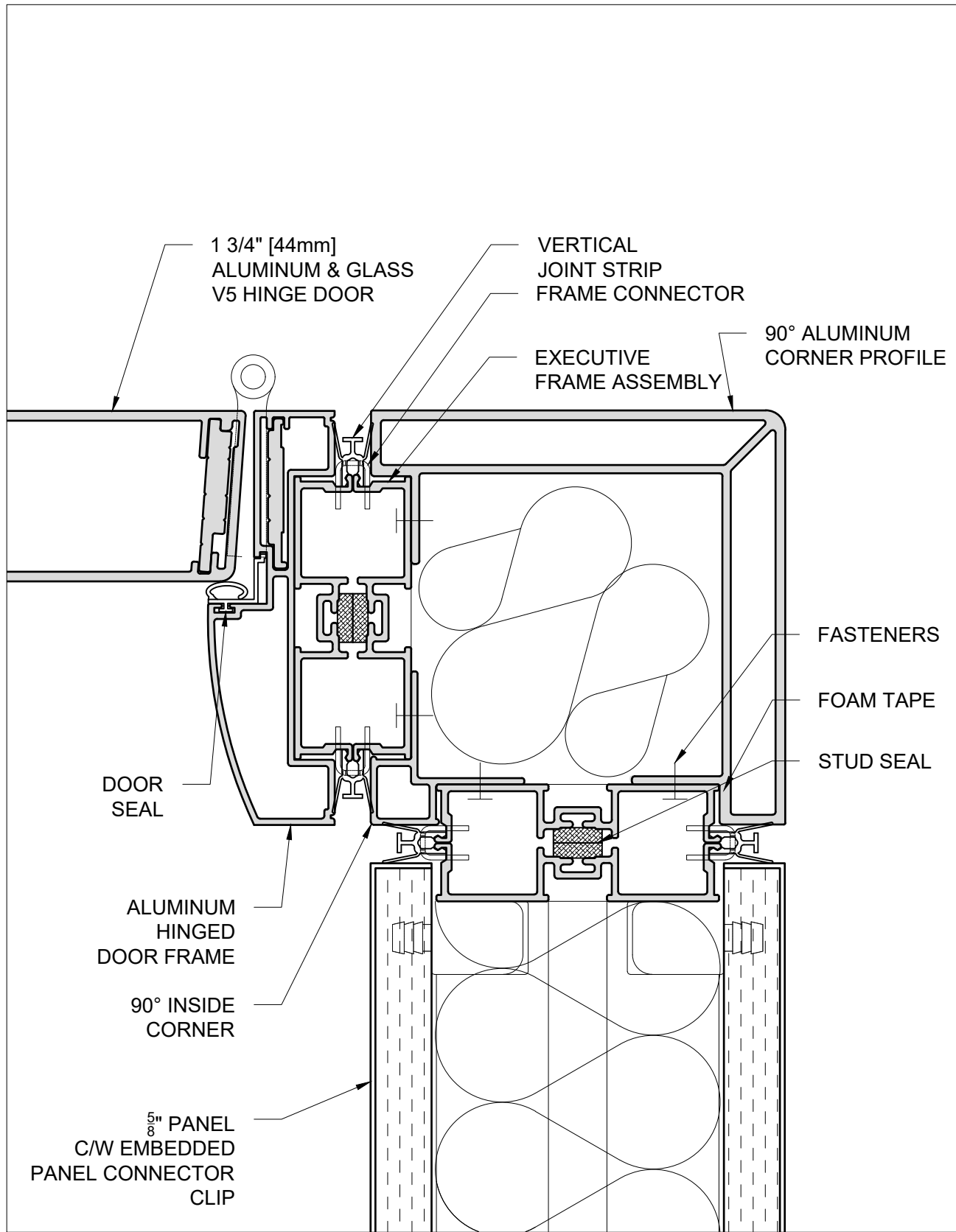



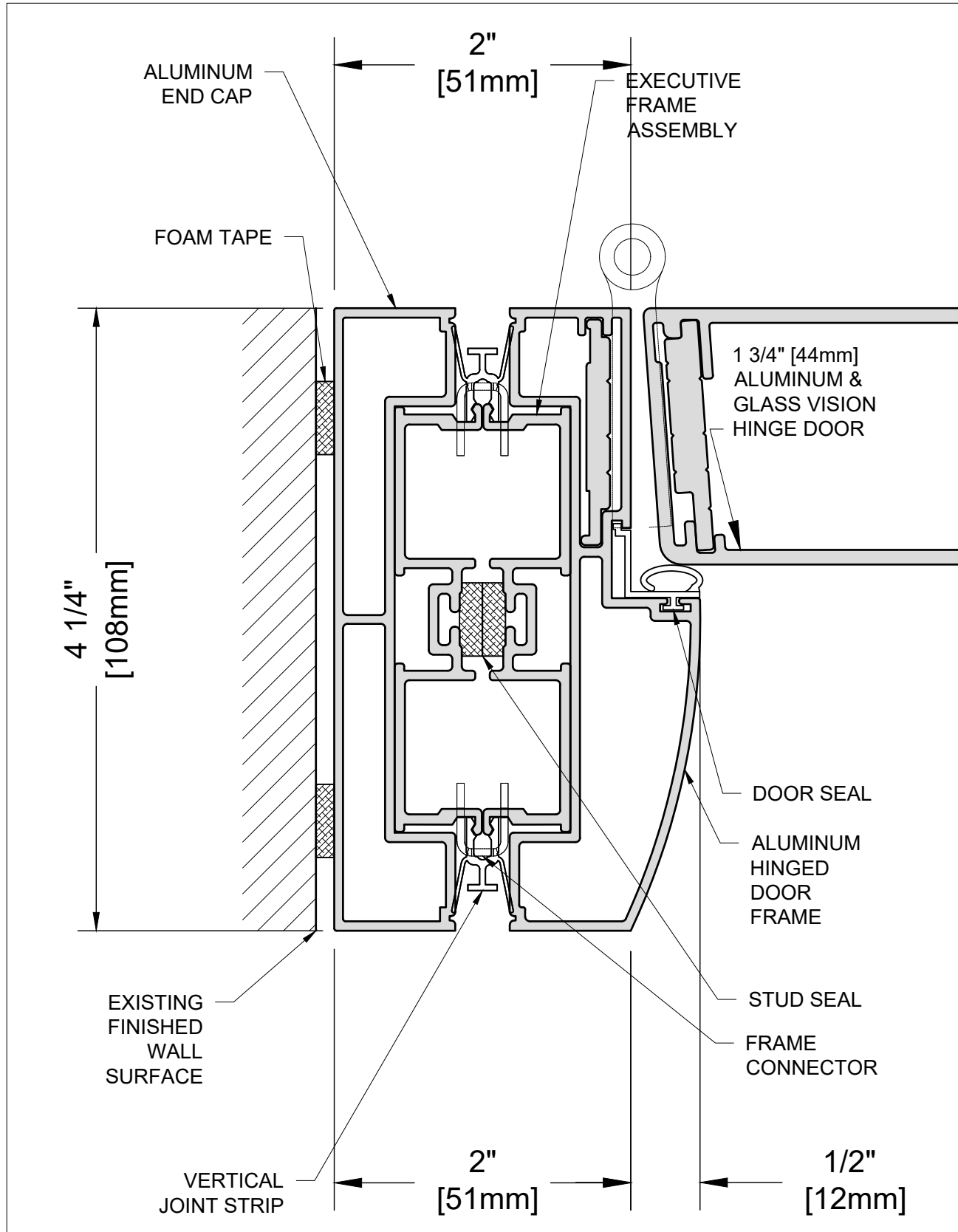

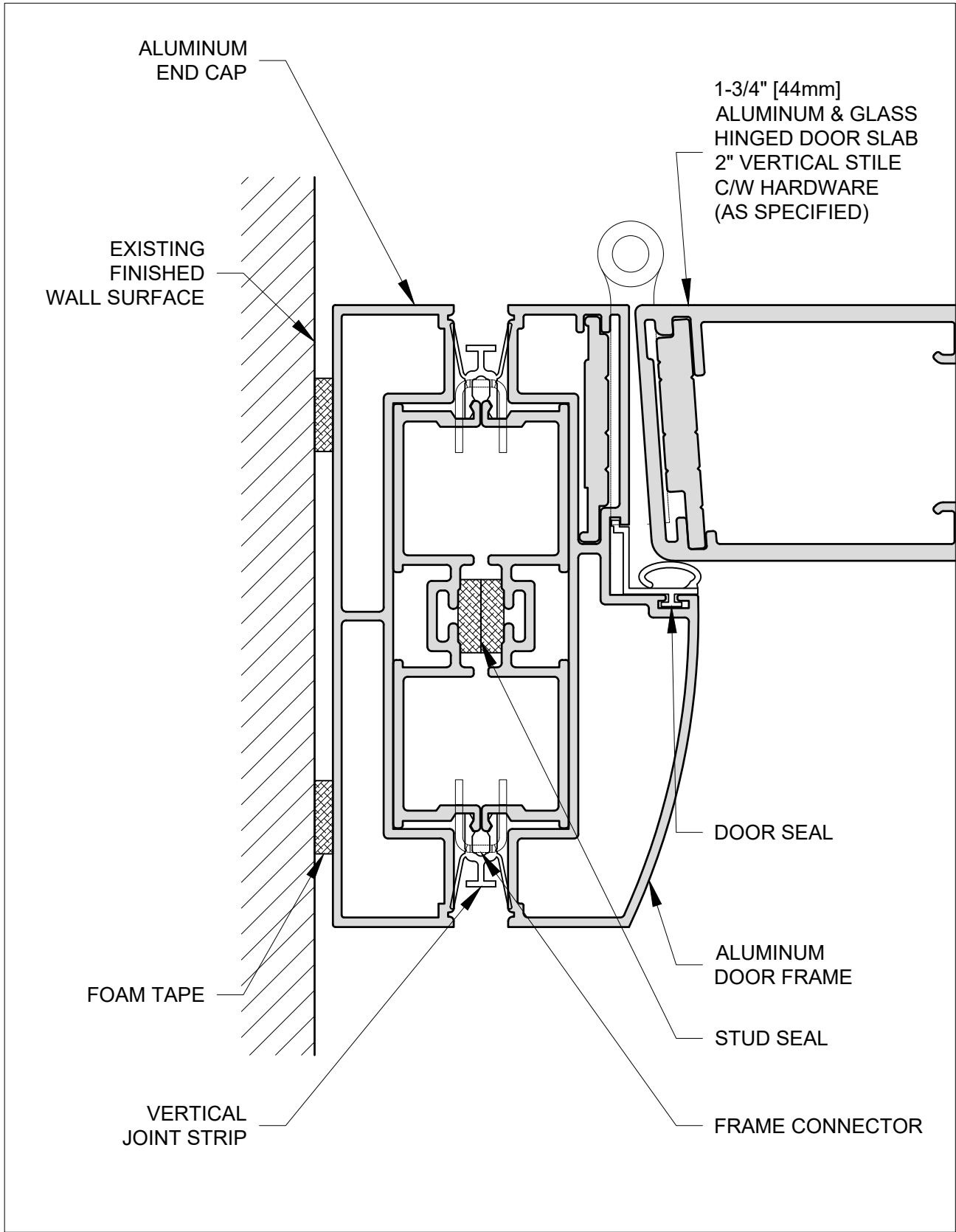

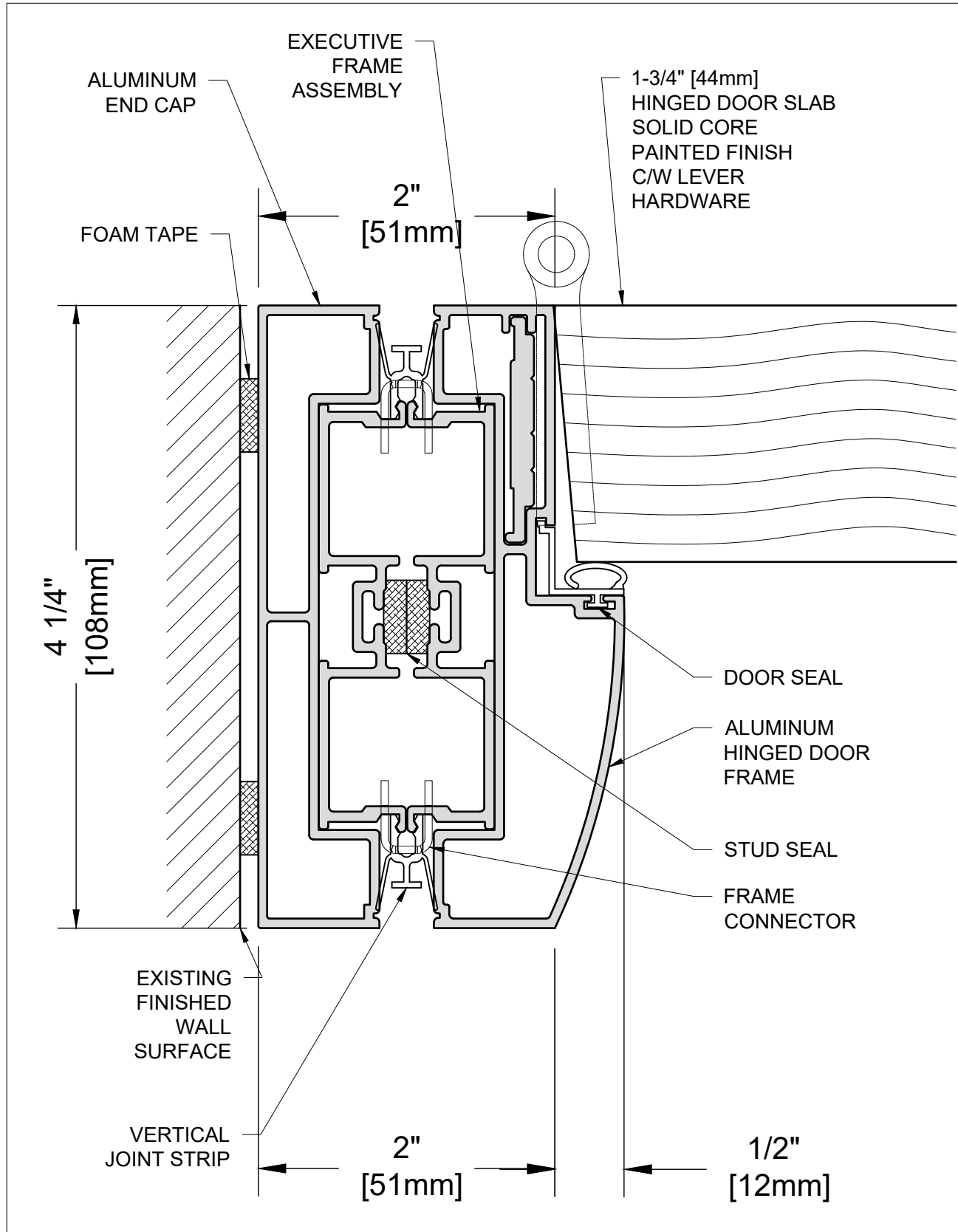

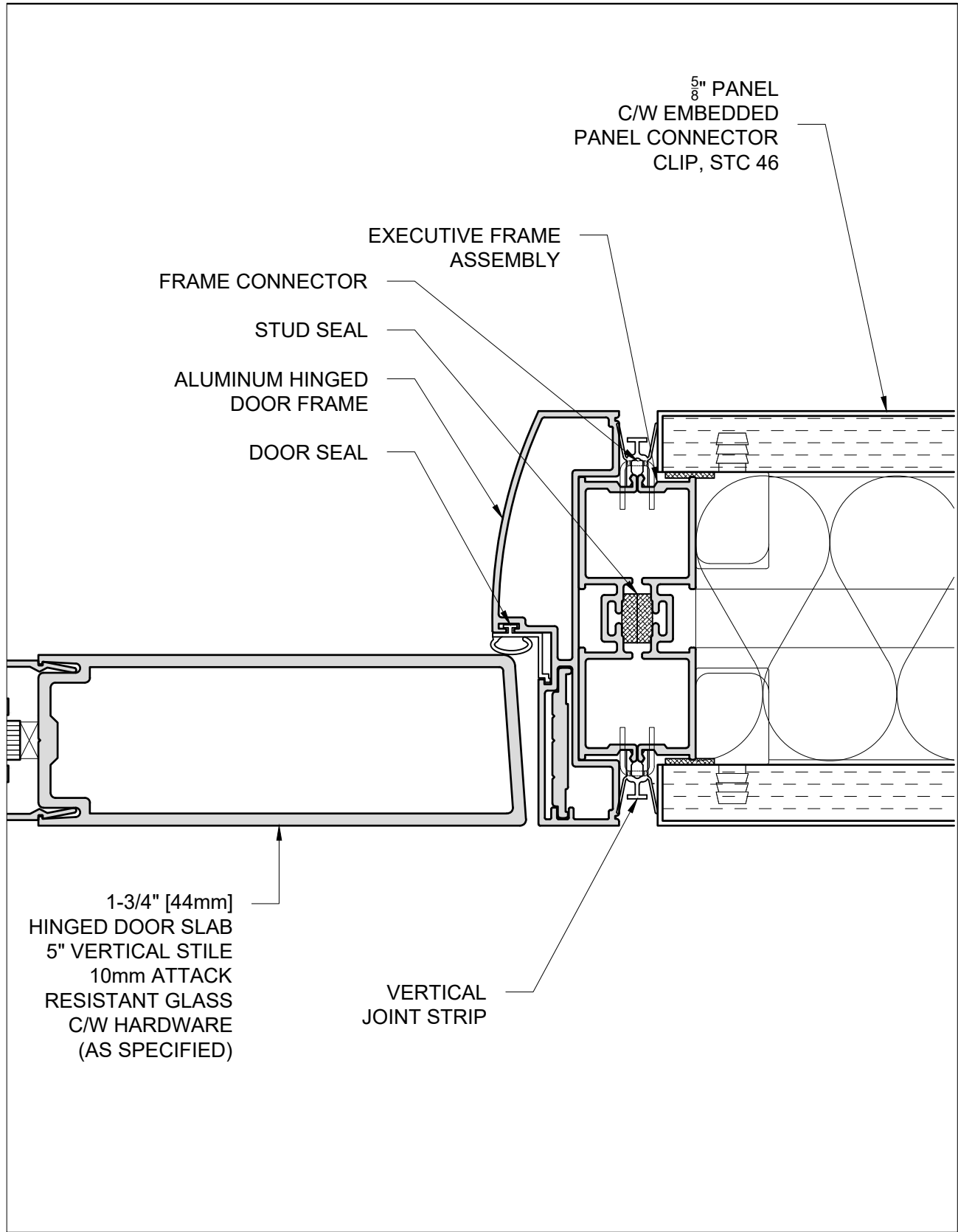

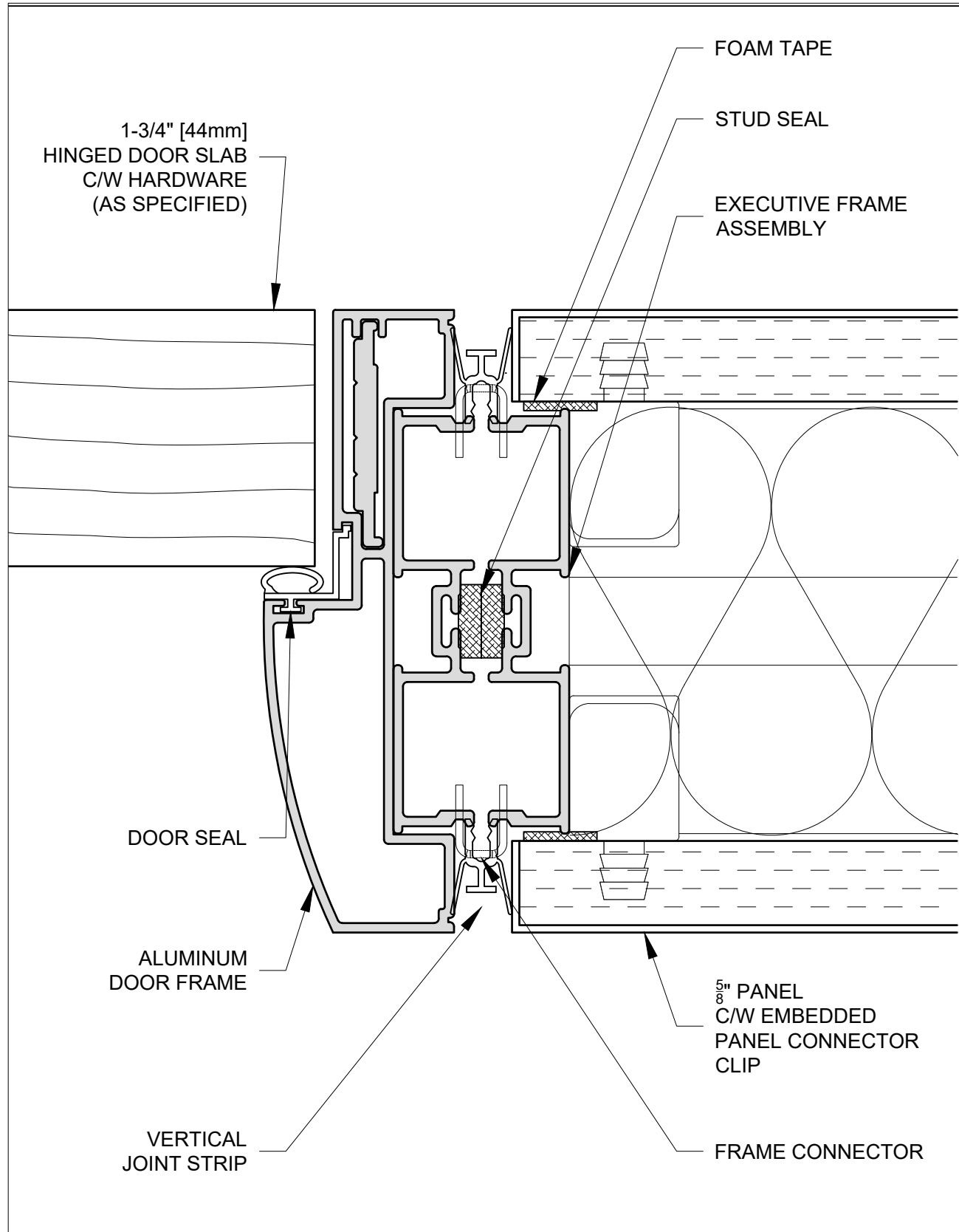

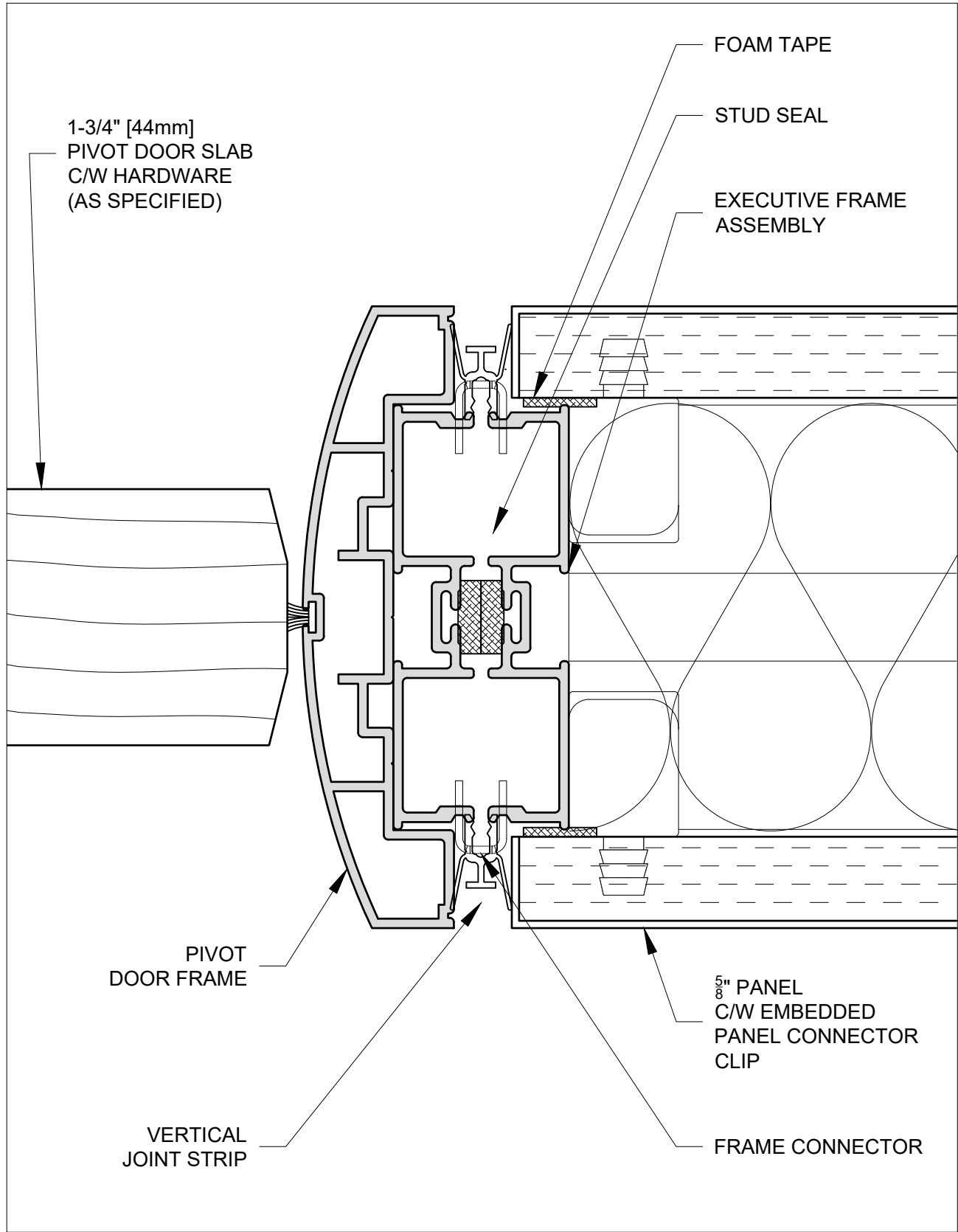

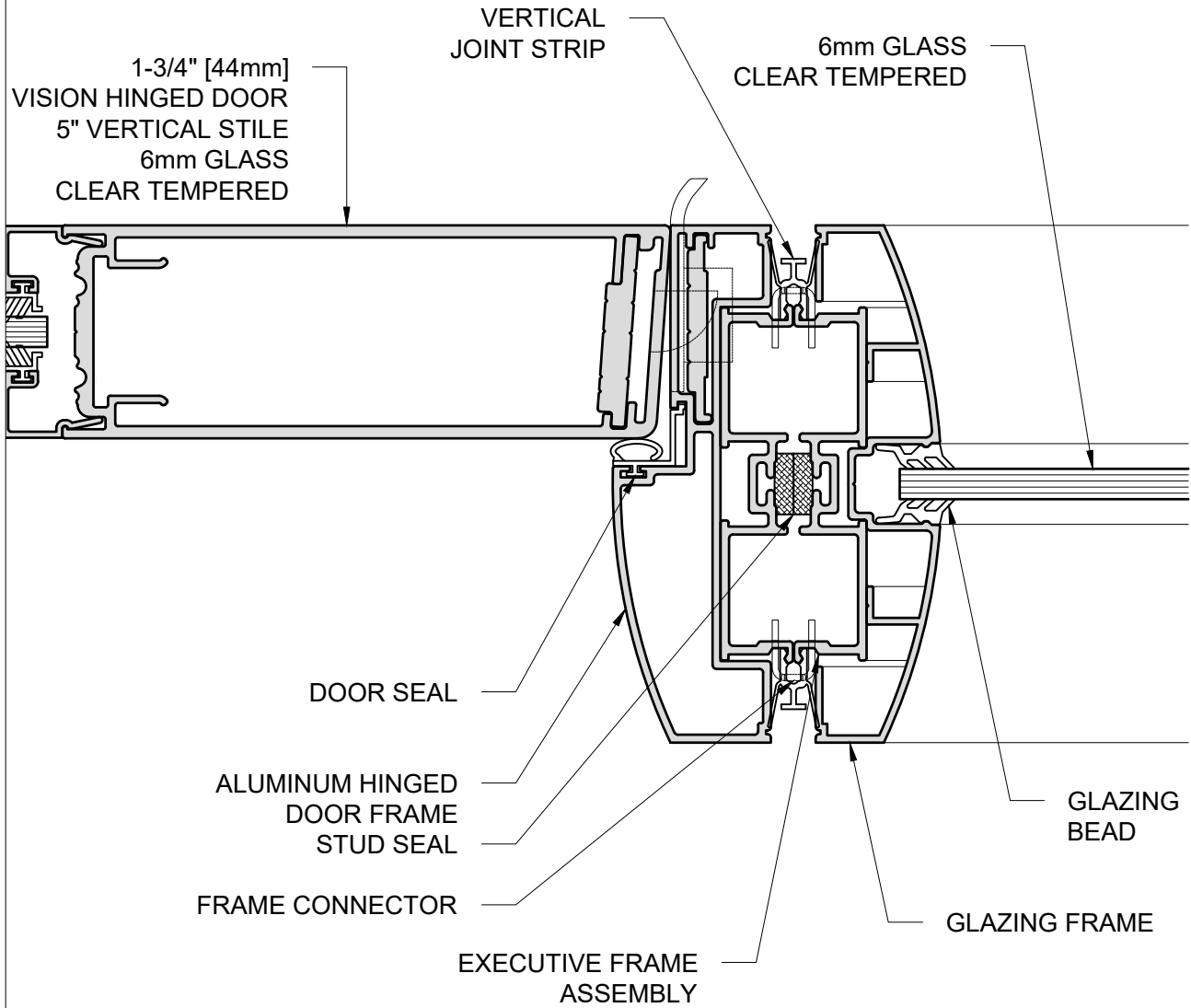

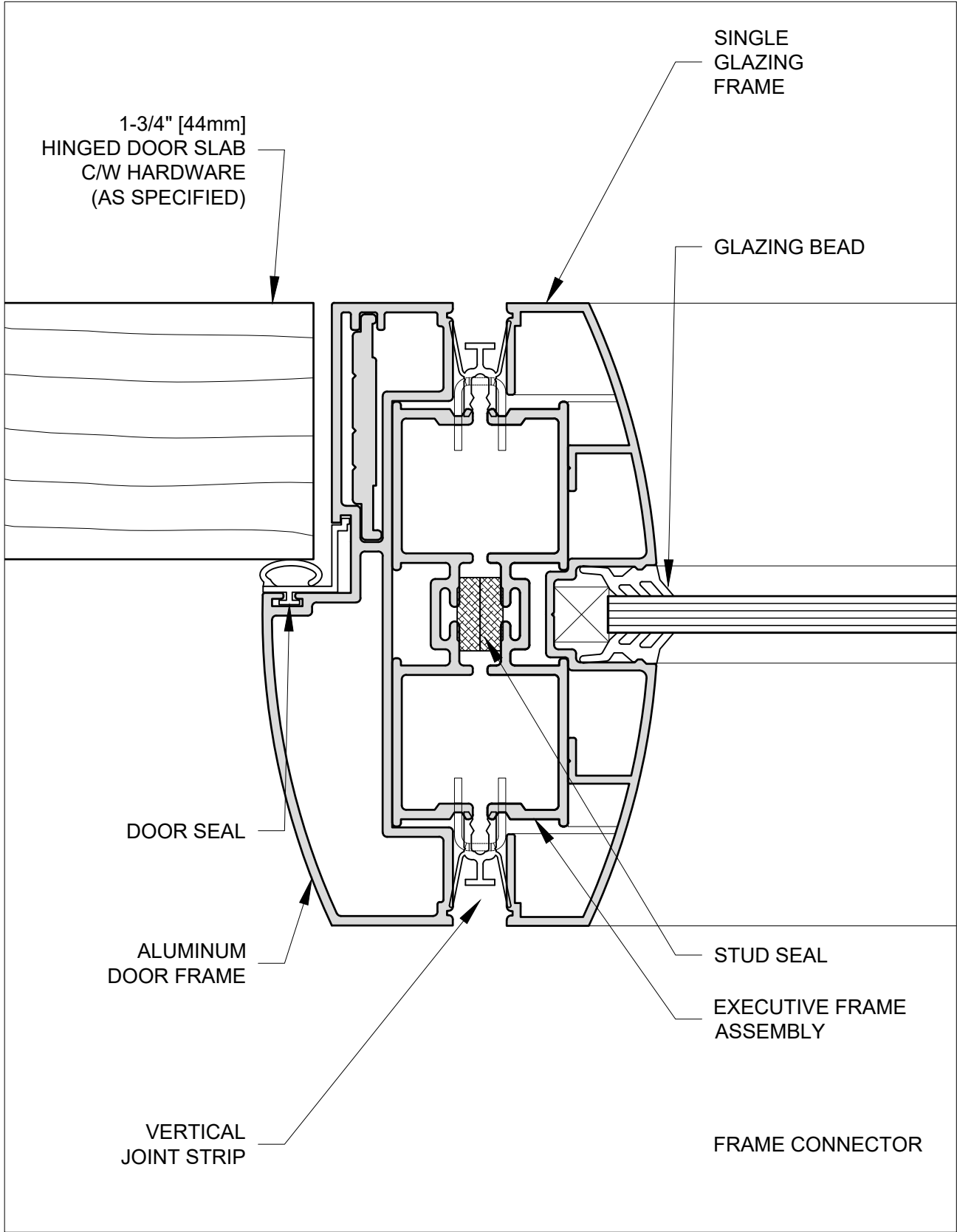

**WD HINGE DOOR, STRIKE  
6mm GLASS PANEL**

DWG:

**4.4.2.3**

FILE:

SCALE: 1 : 1

DATE: OCT 2020



